

 **logli**
SAINT-GOBAIN

NOUVEAU
LM PORTA PRO

Essentiel, avancé,
surprenant.



SAINT-GOBAIN

LM PORTA PRO

Nouveautés
2025

Design

Essentiel, avancé, surprenant.

LM PORTA PRO est un système coulissant qui réunit le **design épuré**, la **polyvalence de conception** et les **hautes performances techniques**.

Des formes carrées, des proportions harmonieuses et des profils optimisés s'intègrent parfaitement à tout type d'environnement, donnant vie à une solution élégante et contemporaine.

Au cœur du système, un **rail compact de 62 x 64 mm** et une **nouvelle pince entièrement en aluminium**, conçus pour assurer la fiabilité et la durabilité. Le résultat ? **Performances testées jusqu'à 45 000 cycles d'ouverture et de fermeture**, pour un emploi intensif et toujours fluide.

L'identité LM PORTA reste facilement reconnaissable :

Fixation au mur ou au plafond

Configurations avec ou sans verre fixe

Un seul amortisseur par vantail qui assure un mouvement fluide et silencieux, à l'ouverture comme à la fermeture

LM PORTA PRO

Le système complet, conçu pour durer.

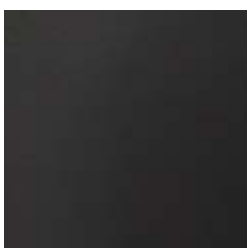
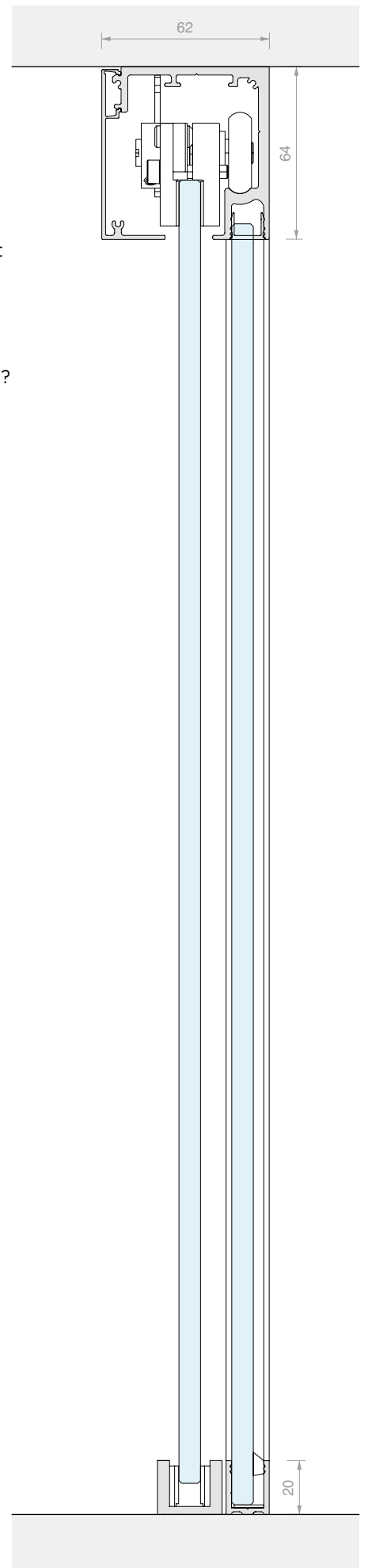

/6
Noir mat



/88
Aluminium effet inox brossé



/97
Aluminium mat

Testé selon UNI EN 1527

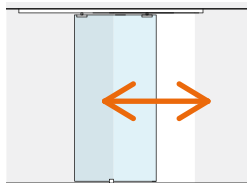

Porte de 100kg plus de **45,000 cycles**

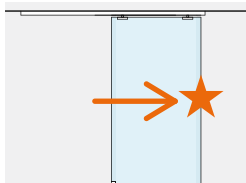

Slam test **DEGRE 3** (degré maximum)

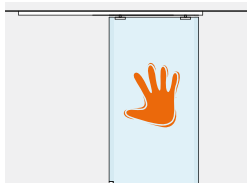

Charge horizontale **DEGRE 3** (degré maximum)

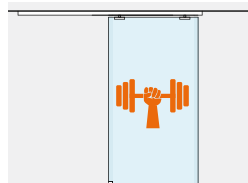

Test de surcharge plus de **200kg** passé

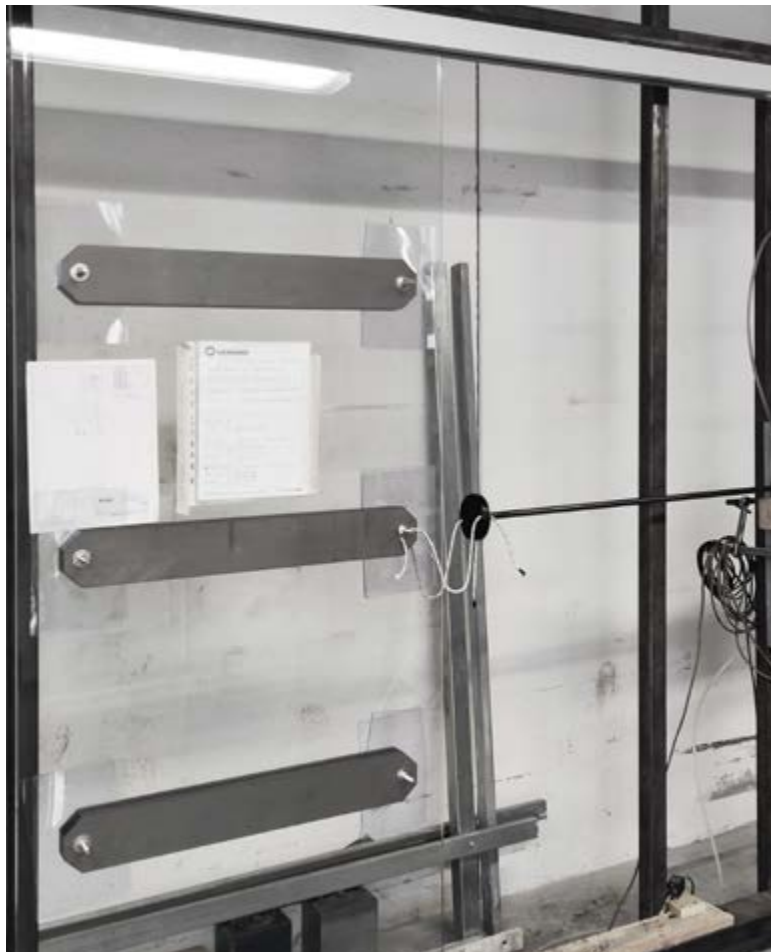

Performances testées jusqu'à 45 000 cycles d'ouverture et de fermeture



Test de surcharge



Pince entièrement en aluminium

LM PORTA PRO

Nouveautés
2025

Caractéristiques techniques

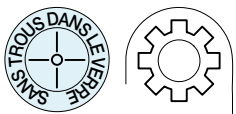

VERRE VANTAIL

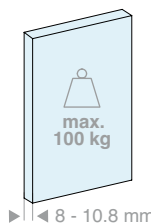

▶ ◀ 8 - 10.8 mm

VERRE FIXE

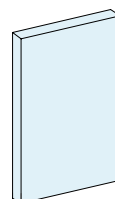

▶ ◀ 8 - 10.8 mm

2 types de montage

Plafond

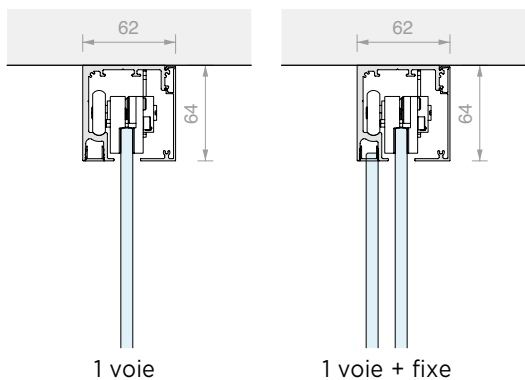

Mur

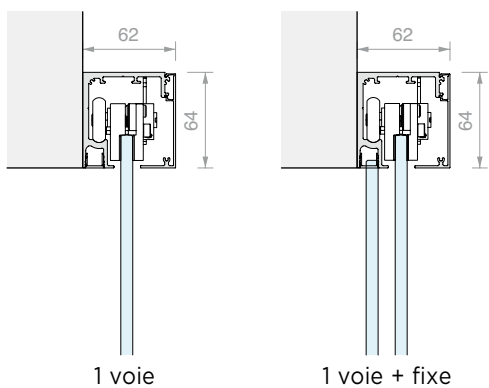

cache h = 63mm

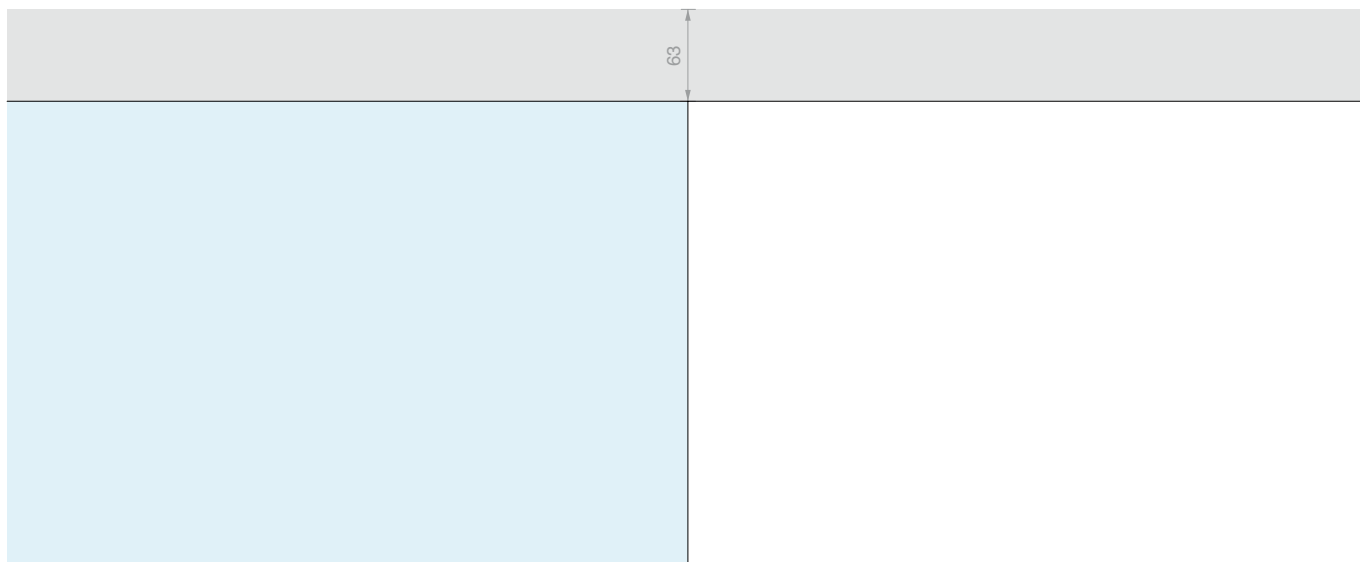

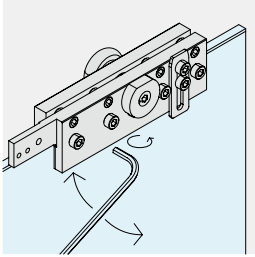
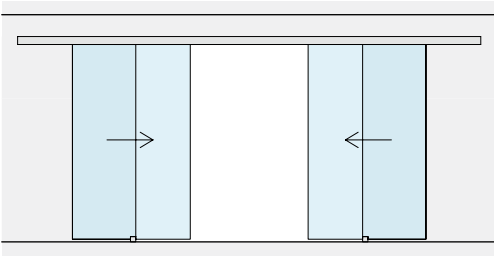

RÉGLAGE DU VANTAIL

La hauteur de chaque chariot peut être réglée pour ajuster la position du vantail de ± 3 mm.

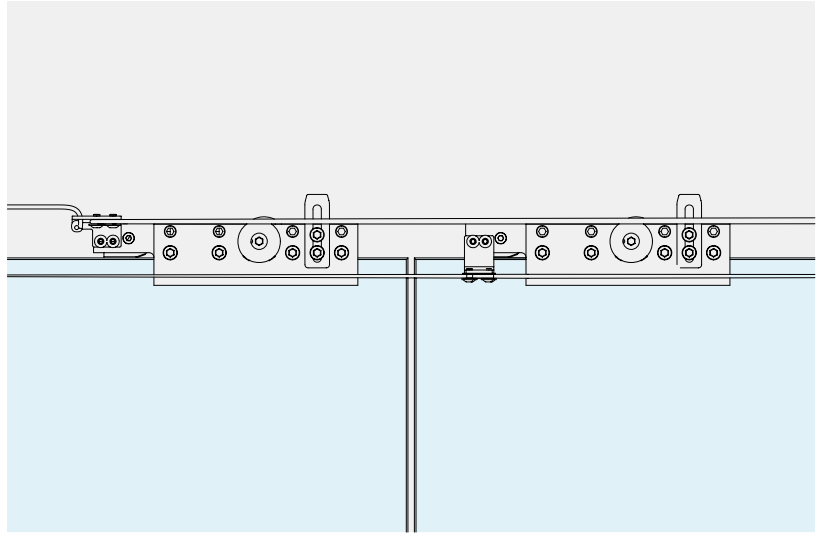

SYNCHRONISME

Des accessoires sont disponibles pour synchroniser 2 vantaux mobiles en opposition.

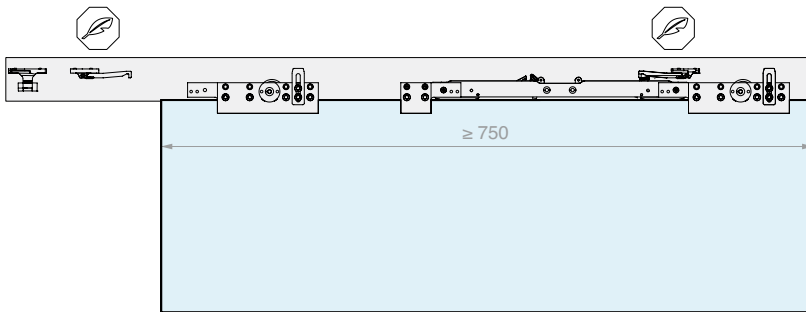

SOFT CLOSE

L'utilisation d'un seul amortisseur permet une ouverture et une fermeture contrôlées et en douceur.

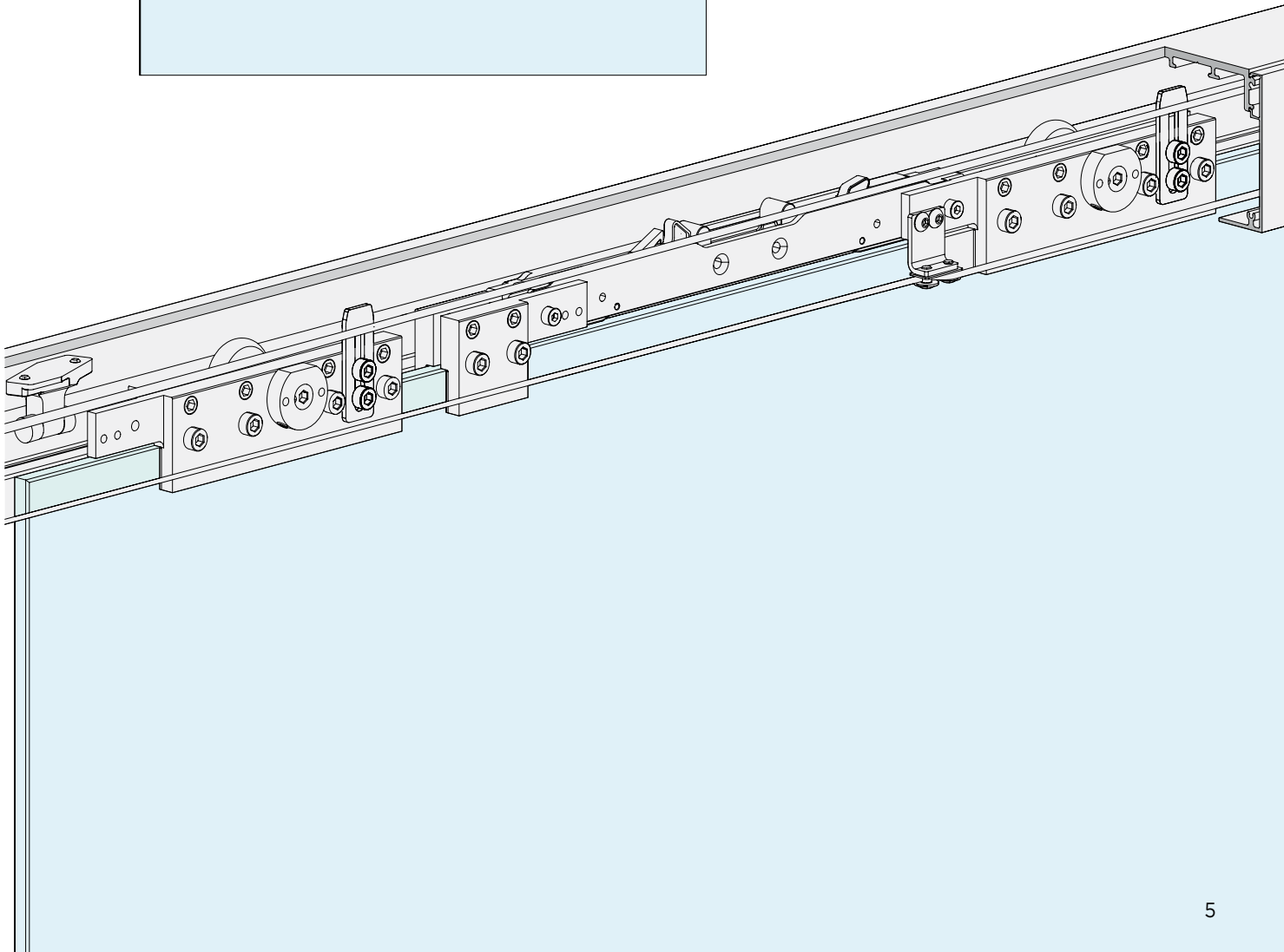



LM PORTA PRO

Kit

MONTAGE AU PLAFOND

VANTAUX MOBILES

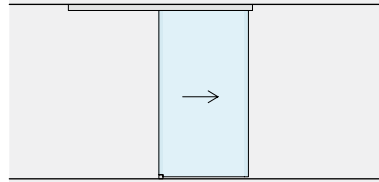

Page 8

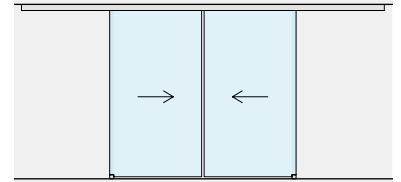

Page 12

VANTAUX MOBILES
AVEC VERRES FIXES

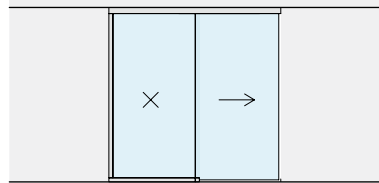

Page 16

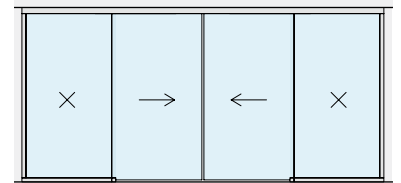

Page 20

MONTAGE MURAL

VANTAUX MOBILES

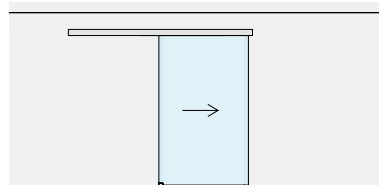

Page 24

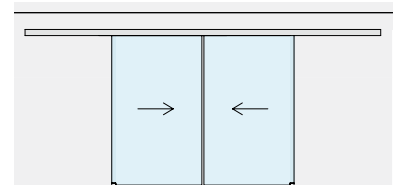

Page 26

VANTAUX MOBILES
AVEC VERRES FIXES

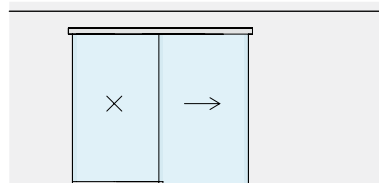

Page 30



Page 32



KIT COULISSANT FIXATION AU PLAFOND SIMPLE VANTAIL

Matériau : Aluminium

Finition : /6 /88 /97

Nouveautés
2025

DIMENSIONS OUVERTURE

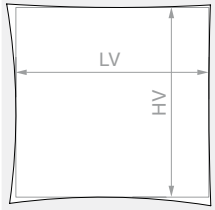

HV max : 3000 mm

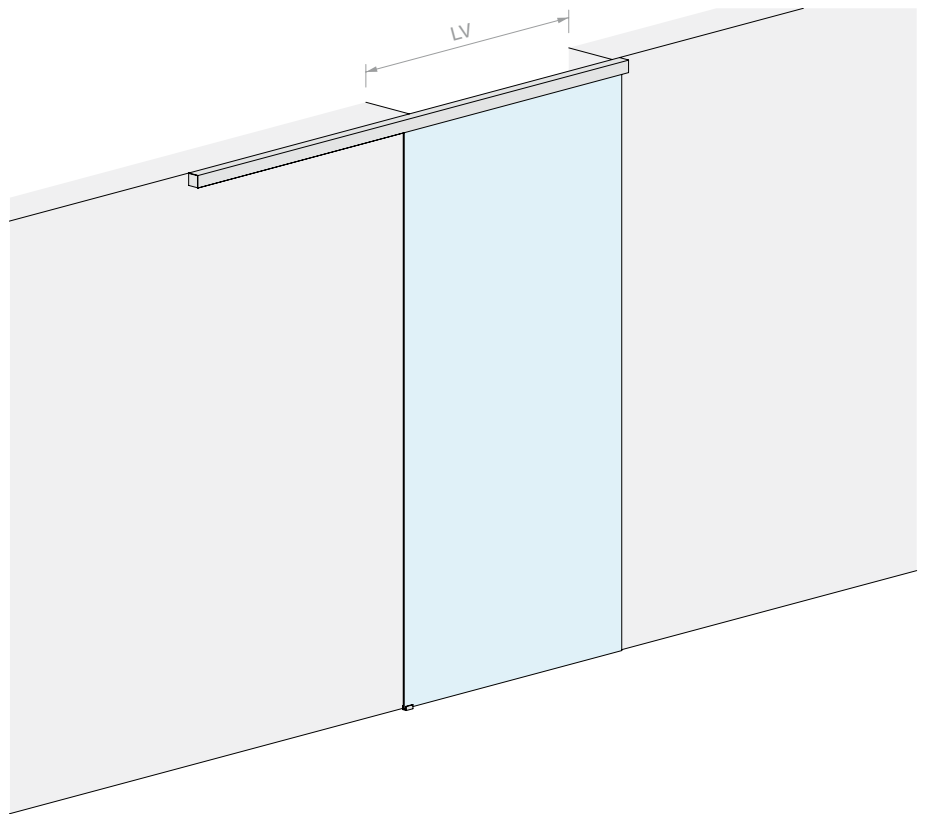

VERRE VANTAIL



8 - 10.8 mm

VERRE VANTAIL

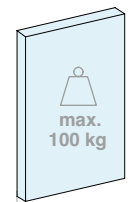

8 - 10.8 mm

Kit composé de :

Réf.	Description	Q.té
LM5864S.200	Rail fixation au plafond	1 U
LM0064CP.200	Cache pour rail	1 U
LMC13.200	Profil de finition	1 U
LM63061TP33	Embout de finition	2 U
CERPOS162	Pince	2 U
LMPS-STP55	Butée sans arrêt	2 U
LMGF	Guide au sol	1 U

En option

LMDMP070ZKIT	Kit amortisseur de 40-70 kg à double action	1 U
LMDMP100ZKIT	Kit amortisseur de 70-100 kg à double action	1 U

Kit composé de :

Réf.	Description	Q.té
LM5864S.300	Rail fixation au plafond	1 U
LM0064CP.300	Cache pour rail	1 U
LMC13.300	Profil de finition	1 U
LM63061TP33	Embout de finition	2 U
CERPOS162	Pince	2 U
LMPS-STP55	Butée sans arrêt	2 U
LMGF	Guide au sol	1 U

En option

LMDMP070ZKIT	Kit amortisseur de 40-70 kg à double action	1 U
LMDMP100ZKIT	Kit amortisseur de 70-100 kg à double action	1 U

Réf.	LV max	Q.té
LMP6511P.200	920 mm	1 U

Réf.	LV max	Q.té
LMP6511P.300	1420 mm	1 U

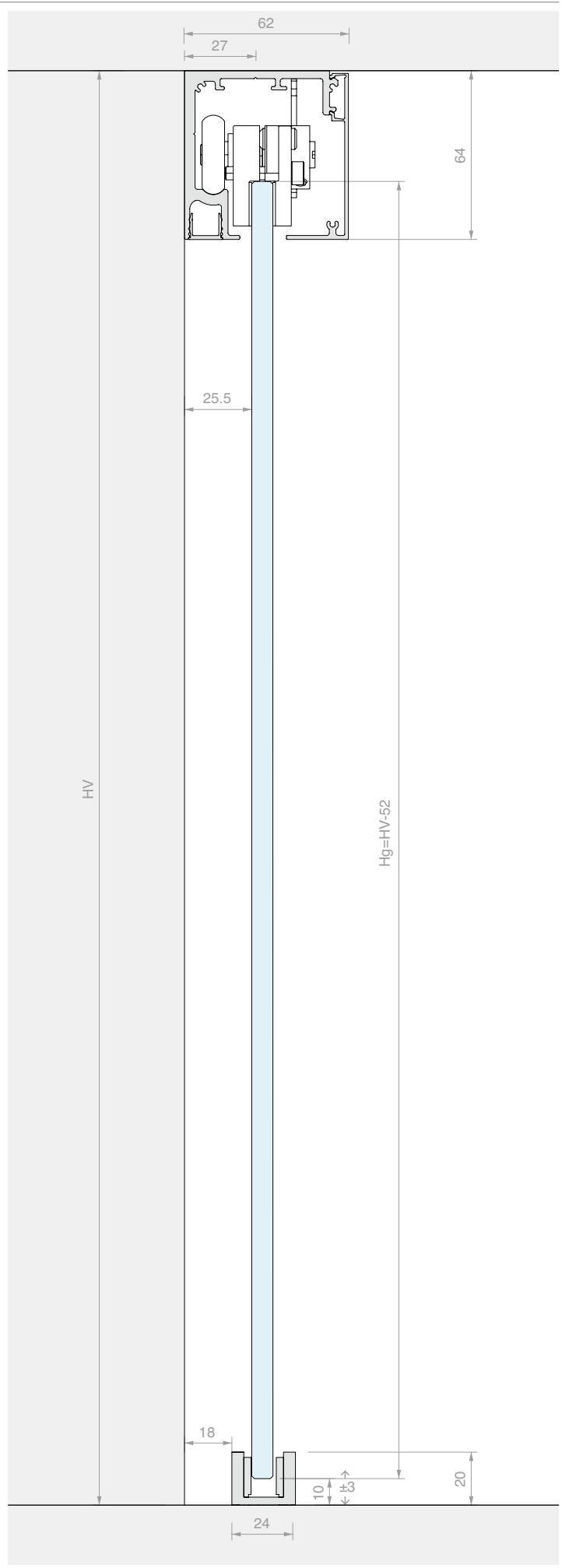
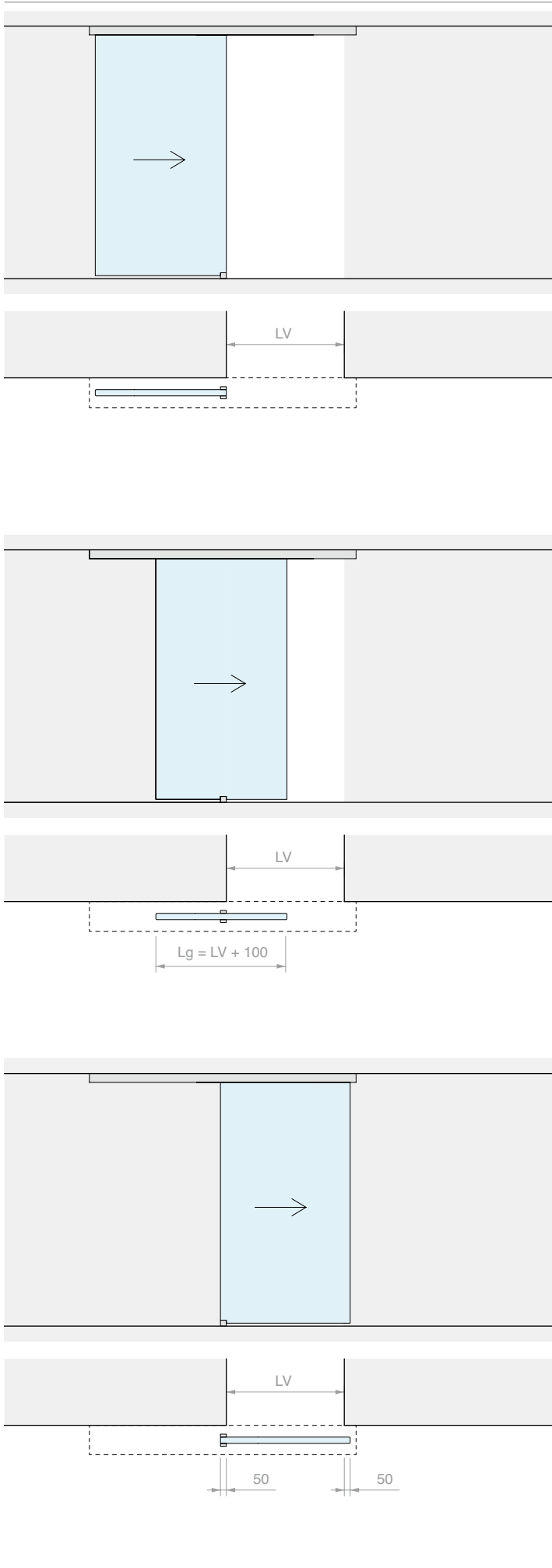







KIT COULISSANT FIXATION AU PLAFOND DOUBLE VANTAIL SYNCHRONISÉ

Matériau : Aluminium

Finition : /6 /88 /97

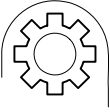
Nouveautés
2025

DIMENSIONS OUVERTURE

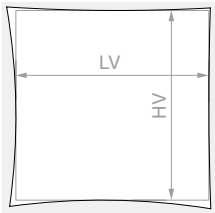

HV max : 3000 mm

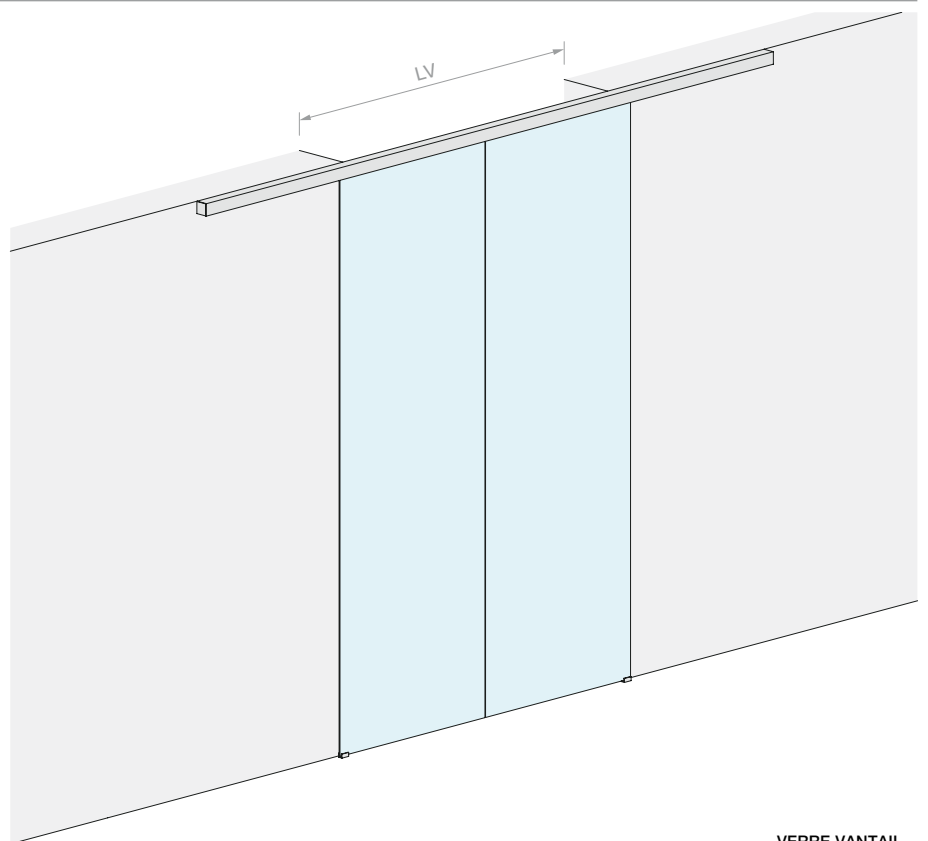

VERRE VANTAIL

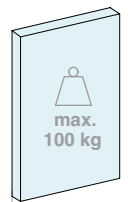

▶ 8 - 10.8 mm

Kit composé de :

Réf.	Description	Q.té
LM5864S.400	Rail fixation au plafond	1 U
LM0064CP.400	Cache pour rail	1 U
LMC13.200	Profil de finition	2 U
LM63061TP33	Embout de finition	2 U
CERPOS162	Pince	4 U
LMPS-STP55	Butée sans arrêt	4 U
LMGF	Guide au sol	2 U
LMSIN-AC55	Kit de synchronisme	1 U

En option

LMDMP100ZKIT	Kit amortisseur de 35-50 kg à double action	1 U
---------------------	---	-----

Réf.	LV max	Q.té
LMP6511CP.400	1940 mm	1 U

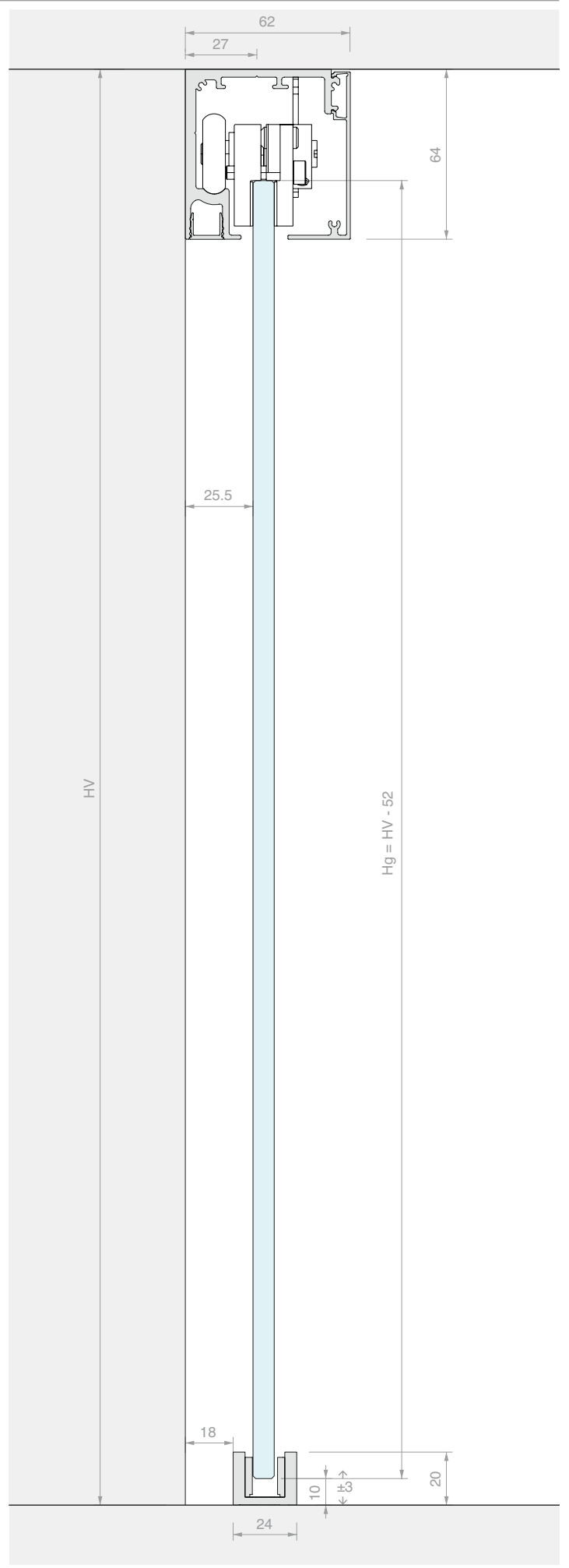
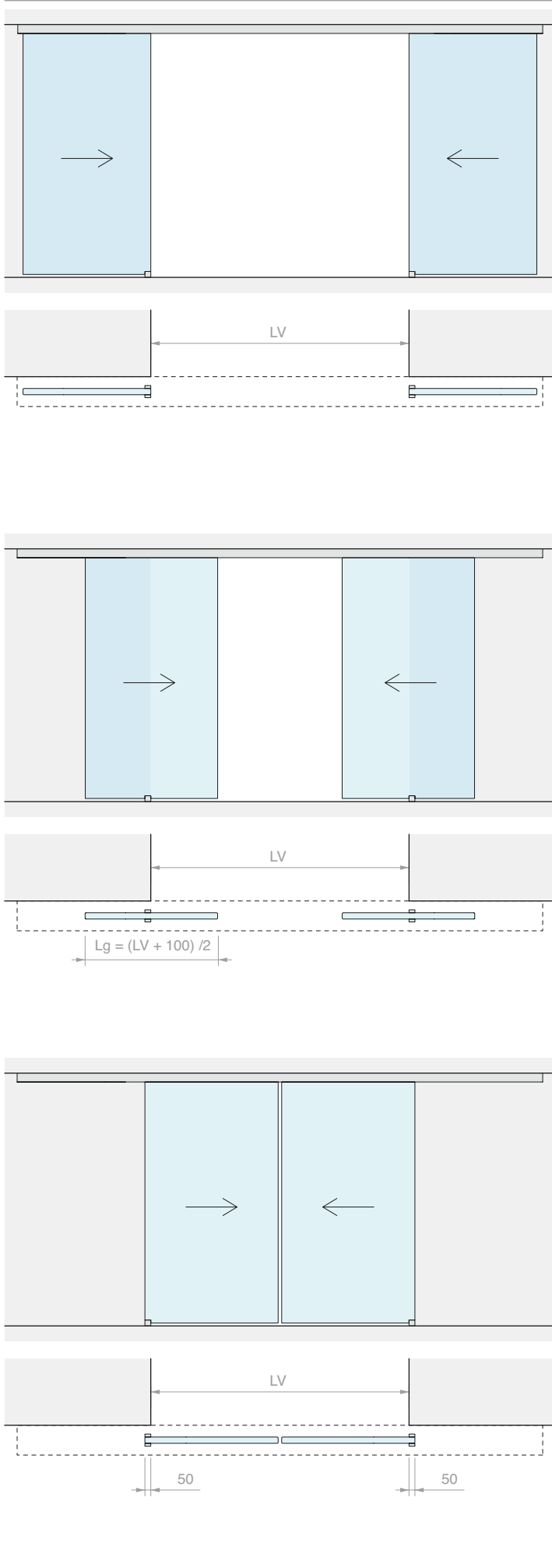







KIT COULISSANT FIXATION AU PLAFOND SIMPLE VANTAIL ET VERRE FIXE

Matériau : Aluminium

Finition : /6 /88 /97

Nouveautés
2025

DIMENSIONS OUVERTURE

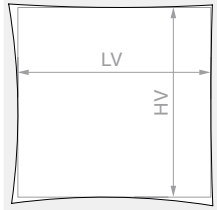

HV max : 3000 mm

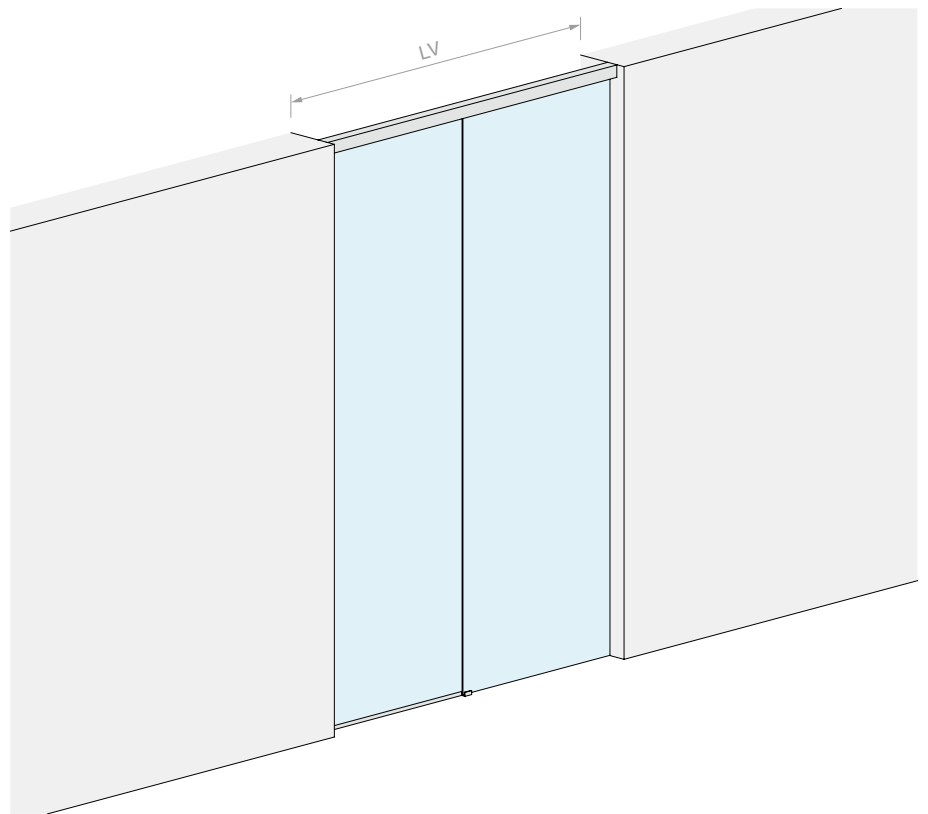

VERRE VANTAIL

VERRE FIXE

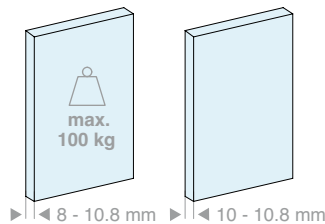

▶ |◀ 8 - 10.8 mm ▶ |◀ 10 - 10.8 mm

VERRE VANTAIL

VERRE FIXE

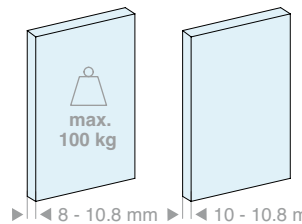

▶ |◀ 8 - 10.8 mm ▶ |◀ 10 - 10.8 mm

Kit composé de :

Réf.	Description	Q.té
LM5864S.200	Rail fixation au plafond	1 U
LM0064CP.200	Cache pour rail	1 U
LMC13.100	Profil de finition	1 U
LMU20.300	Profil en « U »	1 U
LMU20.150	Profil en « U »	1 U
LMU20TP	Embout de finition	1 U
CERPOS162	Pince	2 U
LMPS-STP55	Butée sans arrêt	2 U
GTUP2	Joint pour fixation du verre	5 m
LMGF	Guide au sol	1 U

En option

LMDMP070ZKIT	Kit amortisseur de 40-70 kg à double action	1 U
LMDMP100ZKIT	Kit amortisseur de 70-100 kg à double action	1 U

Kit composé de :

Réf.	Description	Q.té
LM5864S.300	Rail fixation au plafond	1 U
LM0064CP.300	Cache pour rail	1 U
LMC13.200	Profil de finition	1 U
LMU20.300	Profil en « U »	2 U
LMU20TP	Embout de finition	1 U
CERPOS162	Pince	2 U
LMPS-STP55	Butée sans arrêt	2 U
GTUP2	Joint pour fixation du verre	5 m
LMGF	Guide au sol	1 U

En option

LMDMP070ZKIT	Kit amortisseur de 40-70 kg à double action	1 U
LMDMP100ZKIT	Kit amortisseur de 70-100 kg à double action	1 U

Réf.	LV max	Q.té
LMP6511FP.200	2000 mm	1 U

Réf.	LV max	Q.té
LMP6511FP.300	3000 mm	1 U

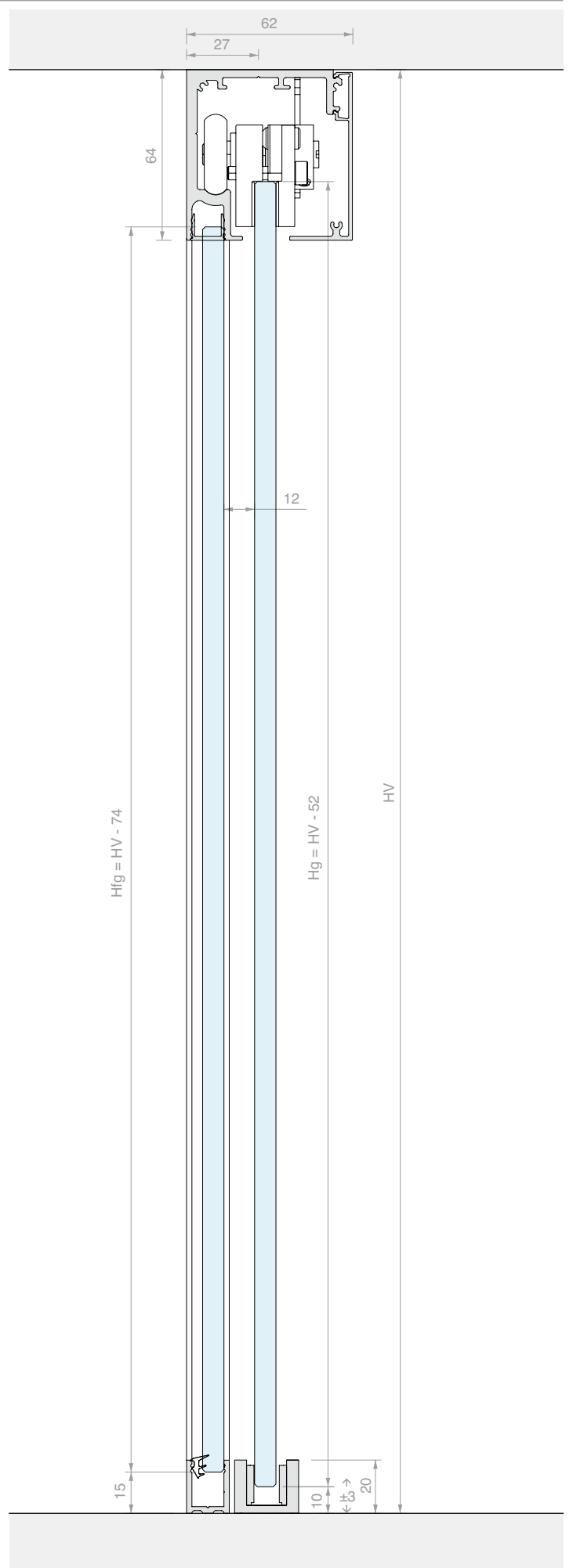
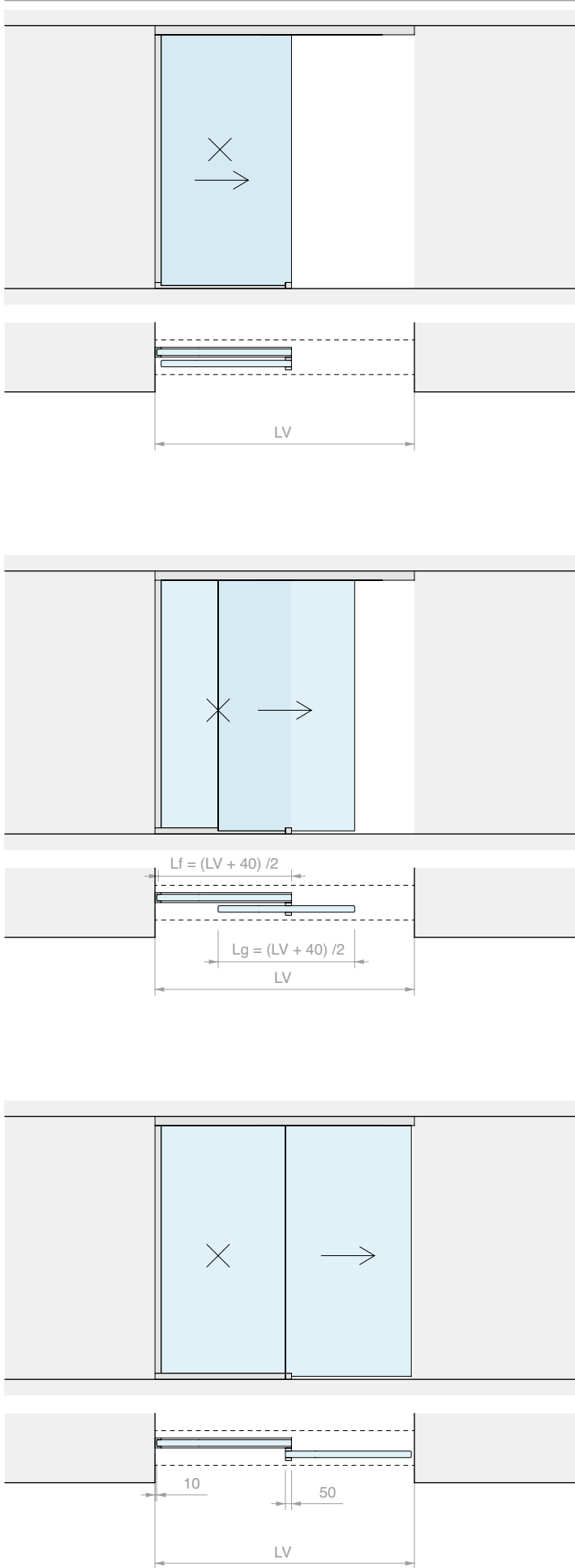







KIT COULISSANT FIXATION AU PLAFOND DOUBLE VANTAIL SYNCHRONISÉ ET DOUBLE VERRE FIXE

Matériau : Aluminium

Finition : /6 /88 /97

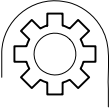
Nouveautés
2025

DIMENSIONS OUVERTURE

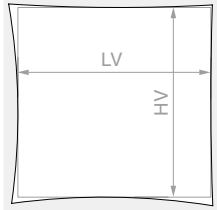

HV max : 3000 mm

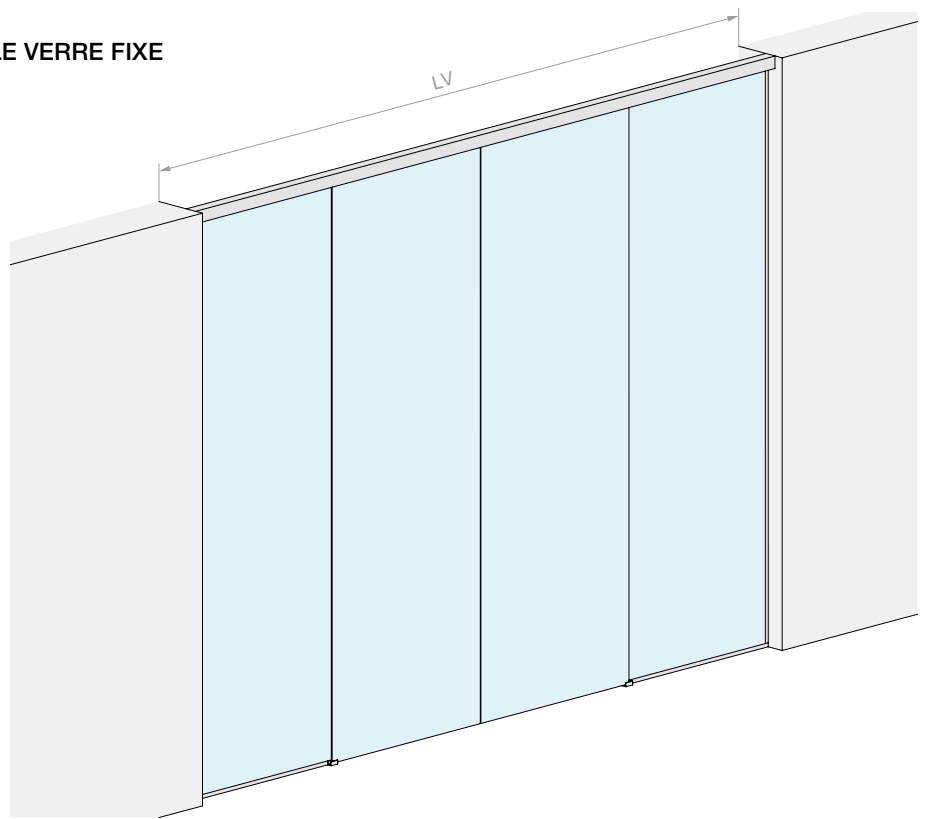

VERRE VANTAIL

VERRE FIXE

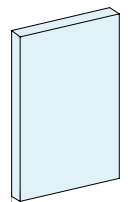

▶ | 8 - 10.8 mm ▶ | 10 - 10.8 mm

Kit composé de :

Réf.	Description	Q.té
LM5864S.400	Rail fixation au plafond	1 U
LM0064CP.400	Cache pour rail	1 U
LMC13.200	Profil de finition	1 U
LMU20.300	Profil en « U »	2 U
LMU20.150	Profil en « U »	2 U
LMU20TP	Embout de finition	2 U
CERPOS162	Pince	4 U
LMPS-STP55	Butée sans arrêt	4 U
GTUP2	Joint pour fixation du verre	10 m
LMGF	Guide au sol	2 U
LMSIN-AC55	Kit de synchronisme	1 U

En option

LMDMP100ZKIT	Kit amortisseur de 35-50 kg à double action	1 U
---------------------	---	-----

Réf.	LV max	Q.té
LMP6511CFP.400	4000 mm	1 U

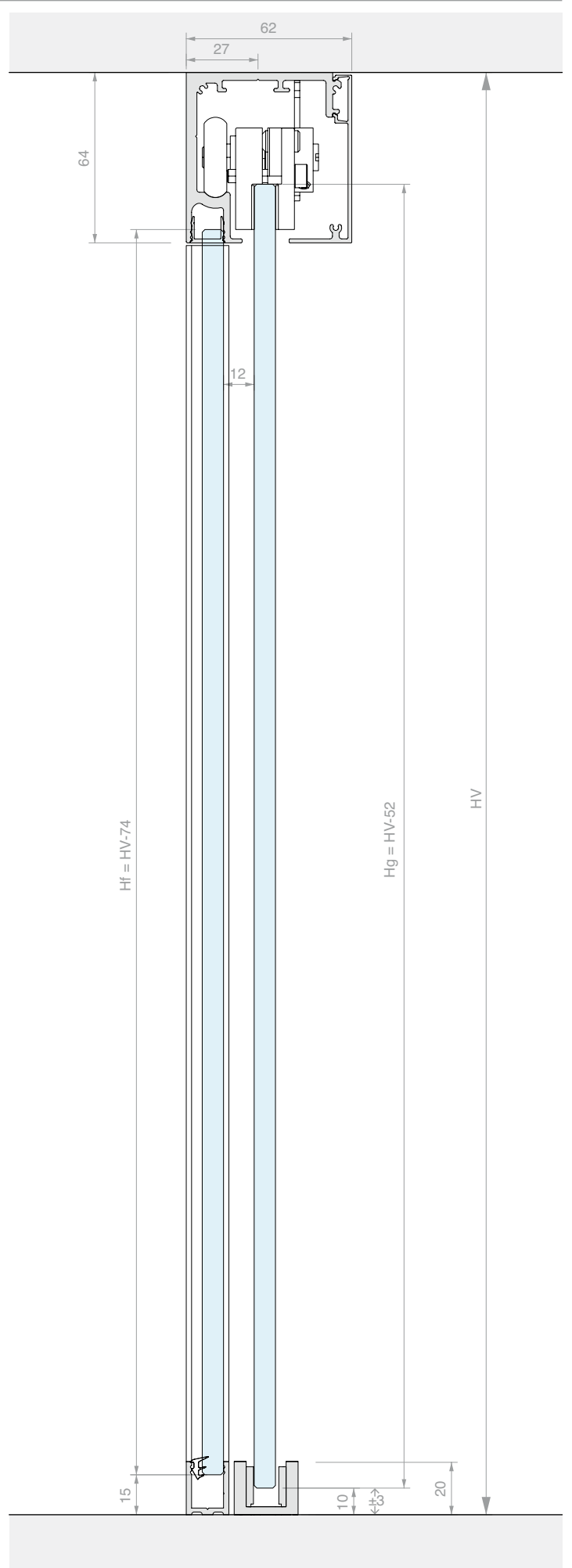
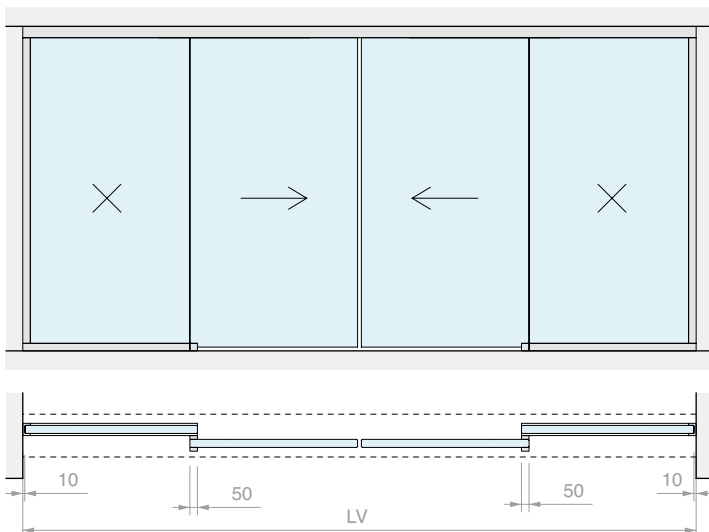
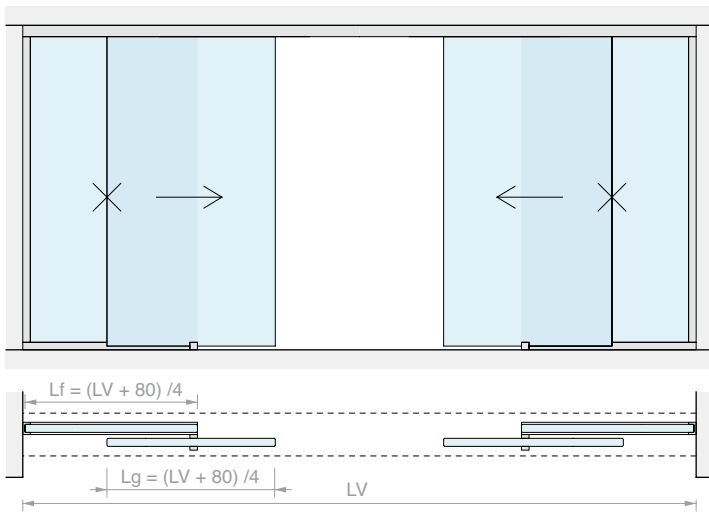
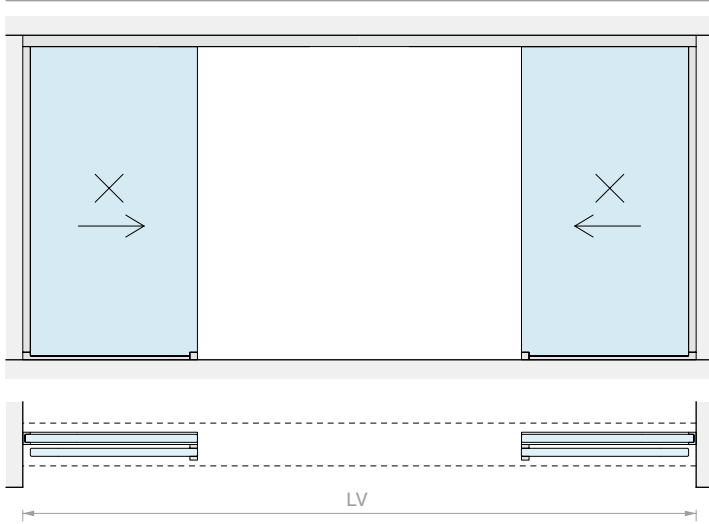







KIT COULISSANT FIXATION MURALE SIMPLE VANTAIL

Matériau : Aluminium

Finition : /6 /88 /97

Nouveautés
2025

DIMENSIONS OUVERTURE

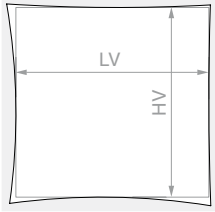

HV max : 3000 mm

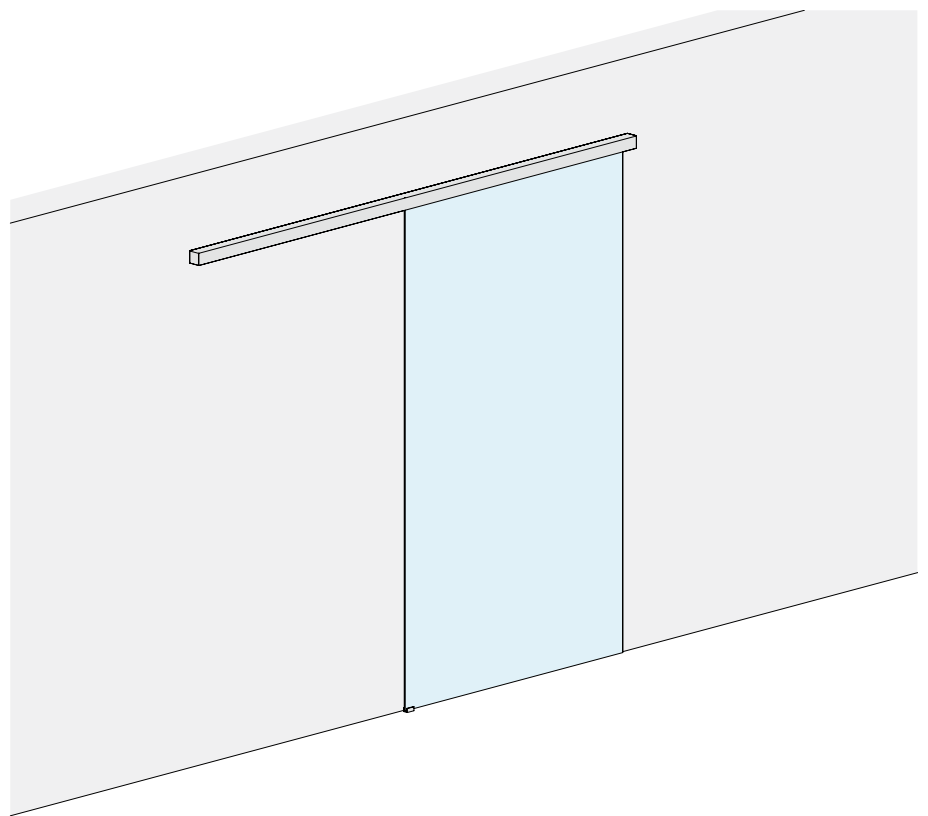

VERRE VANTAIL



▶ | ◀ 8 - 10.8 mm

VERRE VANTAIL

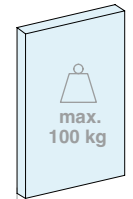

▶ | ◀ 8 - 10.8 mm

Kit composé de :

Réf.	Description	Q.té
LM5864P.200	Rail fixation murale	1 U
LM0064CP.200	Cache pour rail	1 U
LMC13.200	Profil de finition	1 U
LM63061TP33	Embout de finition	2 U
CERPOS162	Pince	2 U
LMPS-STP55	Butée sans arrêt	2 U
LMGF	Guide au sol	1 U

En option

LMDMP070ZKIT	Kit amortisseur de 40-70 kg à double action	1 U
LMDMP100ZKIT	Kit amortisseur de 70-100 kg à double action	1 U

Kit composé de :

Réf.	Description	Q.té
LM5864P.300	Rail de fixation murale	1 U
LM0064CP.300	Cache pour rail	1 U
LMC13.300	Profil de finition	1 U
LM63061TP33	Embout de finition	2 U
CERPOS162	Pince	2 U
LMPS-STP55	Butée sans arrêt	2 U
LMGF	Guide au sol	1 U

En option

LMDMP070ZKIT	Kit amortisseur de 40-70 kg à double action	1 U
LMDMP100ZKIT	Kit amortisseur de 70-100 kg à double action	1 U

Réf.	LV max	Q.té
LMP6521P.200	920 mm	1 U

Réf.	LV max	Q.té
LMP6521P.300	1420 mm	1 U

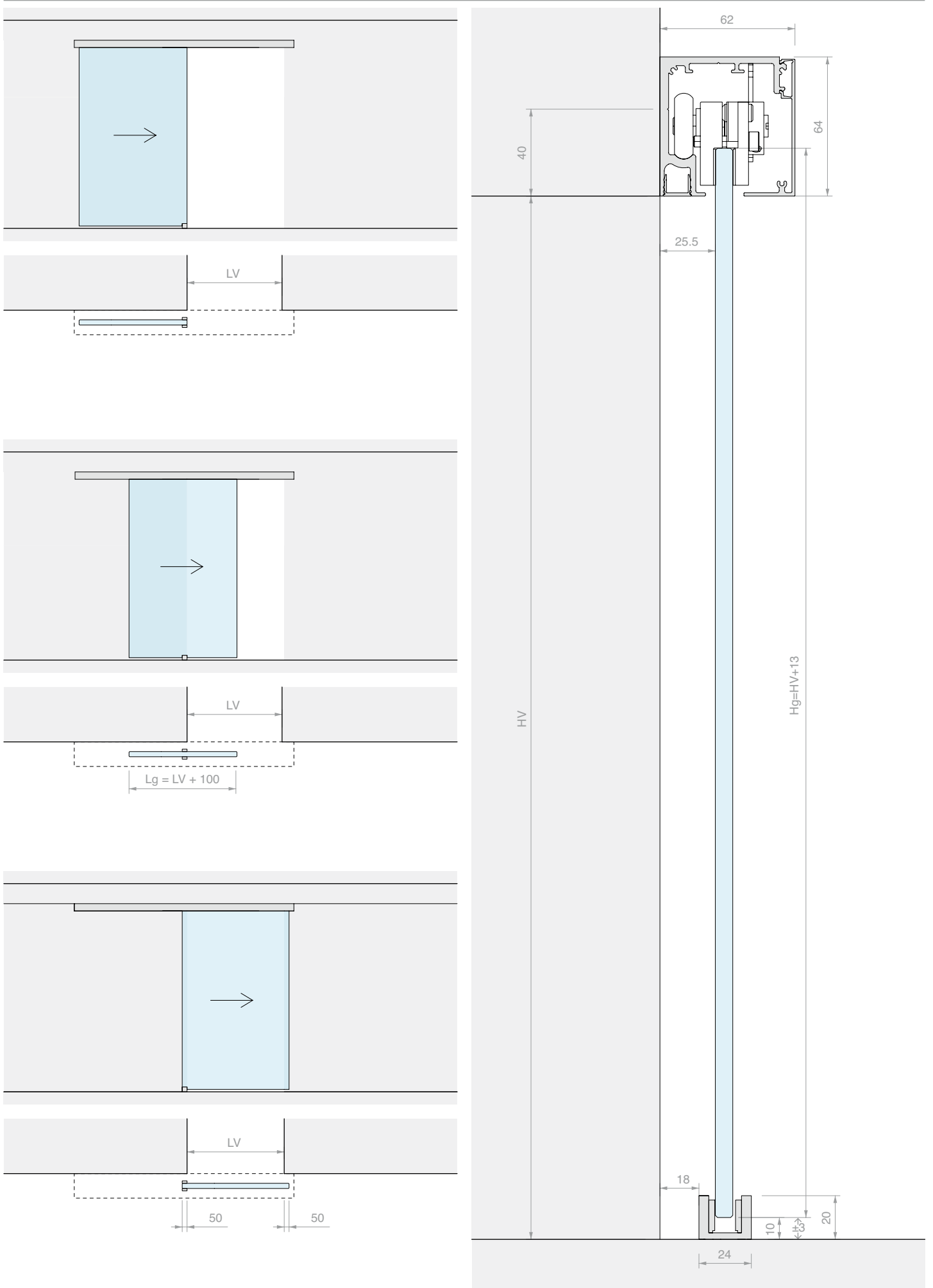



KIT COULISSANT FIXATION MURALE DOUBLE VANTAIL SYNCHRONISÉ

Matériau : Aluminium

Finition : /6 /88 /97

Nouveautés
2025

DIMENSIONS OUVERTURE

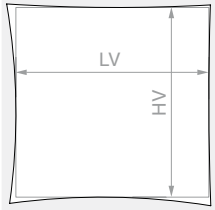

HV max : 3000 mm

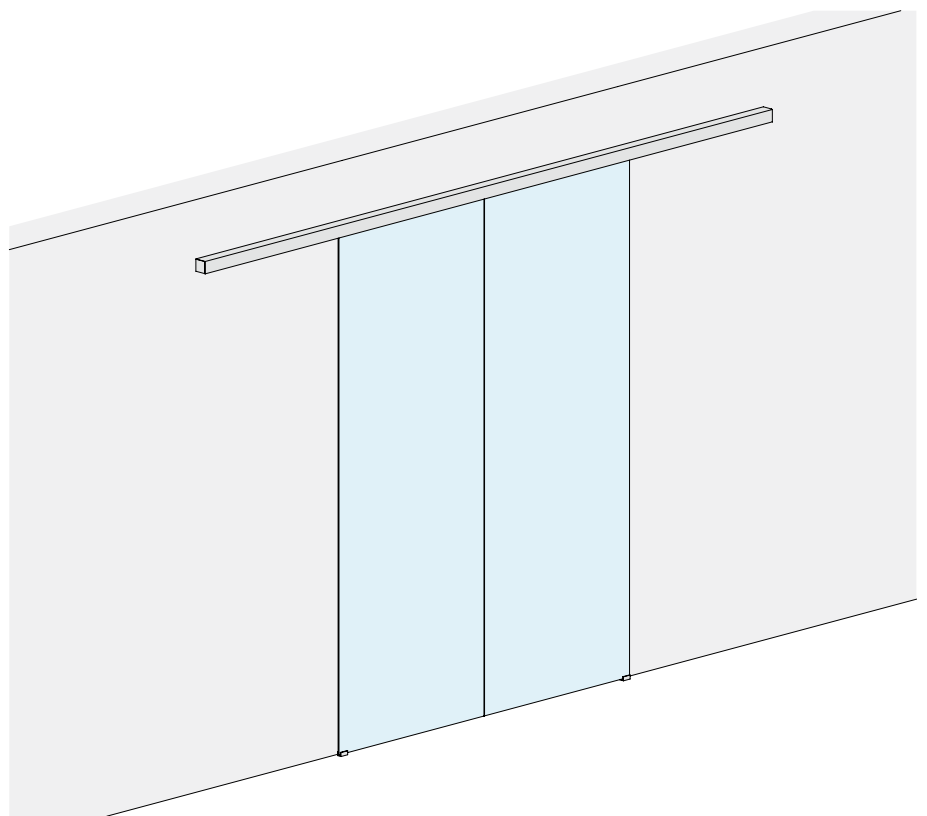

VERRE VANTAIL

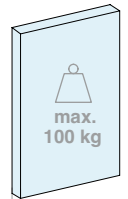

▶ | ◀ 8 - 10.8 mm

Kit composé de :

Réf.	Description	Q.té
LM5864P.400	Rail fixation murale	1 U
LM0064CP.400	Cache pour rail	1 U
LMC13.200	Profil de finition	2 U
LM63061TP33	Embout de finition	2 U
CERPOS162	Pince	4 U
LMPS-STP55	Butée sans arrêt	4 U
LMGF	Guide au sol	2 U
LMSIN-AC55	Kit de synchronisme	1 U

En option

LMDMP100ZKIT	Kit amortisseur de 35-50 kg à double action	1 U
---------------------	---	-----

Réf.	LV max	Q.té
LMP6521CP.400	1940 mm	1 U

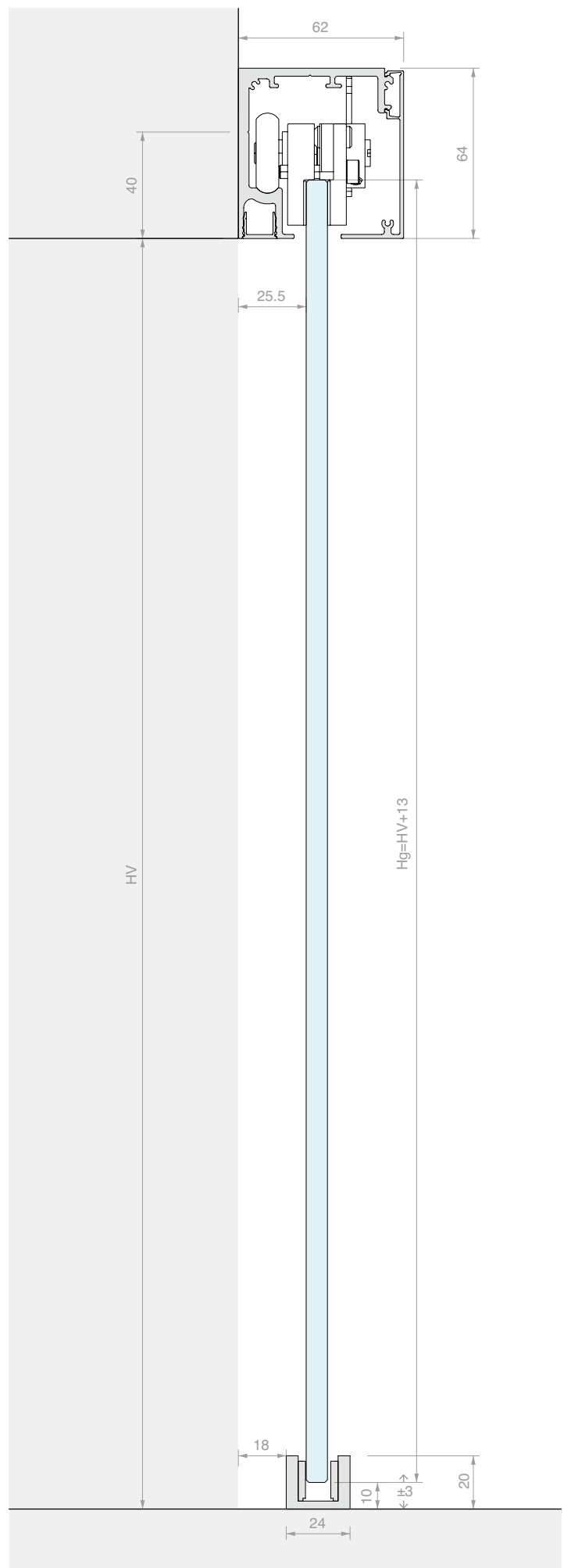
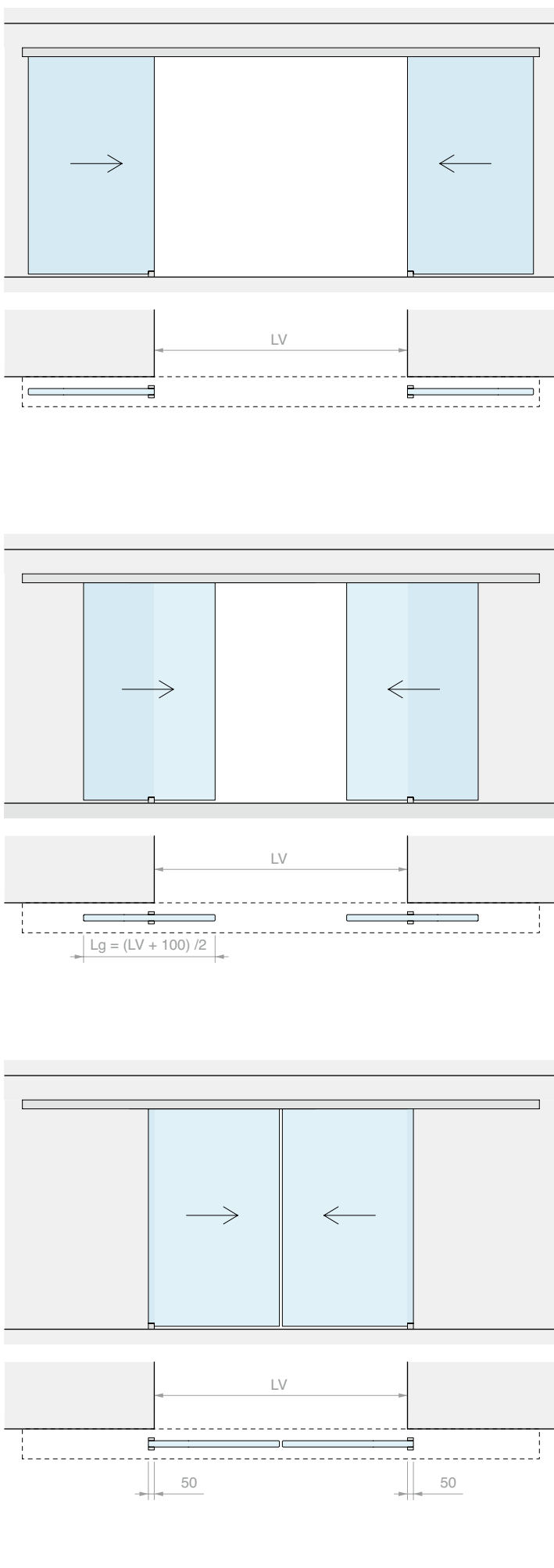







KIT COULISSANT FIXATION MURALE SIMPLE VANTAIL ET VERRE FIXE

Matériau : Aluminium

Finition : /6 /88 /97

Nouveautés
2025

DIMENSIONS OUVERTURE

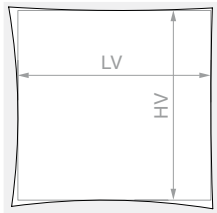

HV max : 3000 mm

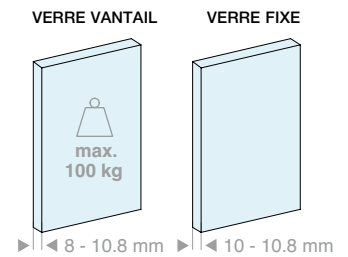
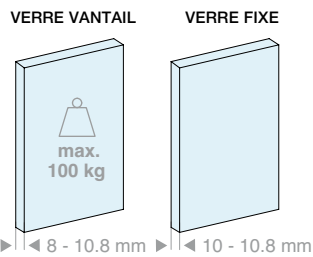
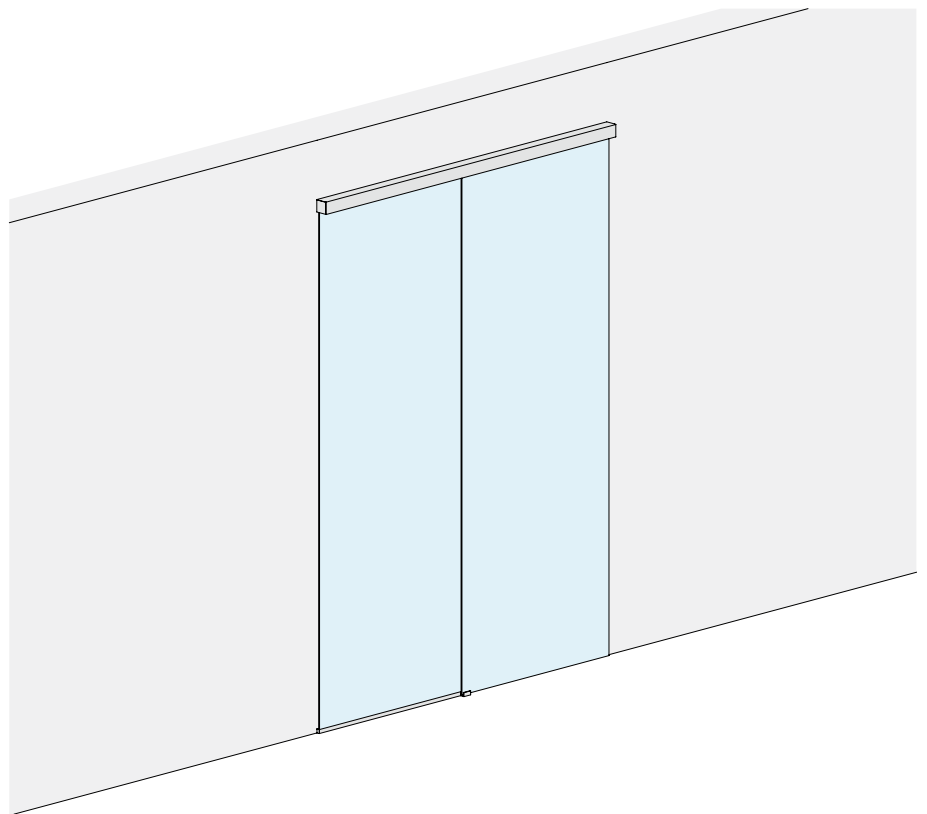

Kit composé de :

Réf.	Description	Q.té
LM5864P.200	Rail fixation murale	1 U
LM0064CP.200	Cache pour rail	1 U
LMC13.100	Profil de finition	1 U
LMU20.150	Profil en « U »	1 U
LM63061TP33	Embout de finition	2 U
LMU20TP	Embout de finition	2 U
CERPOS162	Pince	2 U
LMPS-STP55	Butée sans arrêt	2 U
GTUP2	Joint pour fixation du verre	5 m
LMGF	Guide au sol	1 U

En option

LMDMP070ZKIT	Kit amortisseur de 40-70 kg à double action	1 U
LMDMP100ZKIT	Kit amortisseur de 70-100 kg à double action	1 U

Kit composé de :

Réf.	Description	Q.té
LM5864P.300	Rail fixation murale	1 U
LM0064CP.300	Cache pour rail	1 U
LMC13.200	Profil de finition	1 U
LMU20.300	Profil en « U »	1 U
LM63061TP33	Embout de finition	2 U
LMU20TP	Embout de finition	2 U
CERPOS162	Pince	2 U
LMPS-STP55	Butée sans arrêt	2 U
GTUP2	Joint pour fixation du verre	5 m
LMGF	Guide au sol	1 U

En option

LMDMP070ZKIT	Kit amortisseur de 40-70 kg à double action	1 U
LMDMP100ZKIT	Kit amortisseur de 70-100 kg à double action	1 U

Réf.	LV max	Q.té
LMP6521FP.200	1880 mm	1 U

Réf.	LV max	Q.té
LMP6521FP.300	2880 mm	1 U

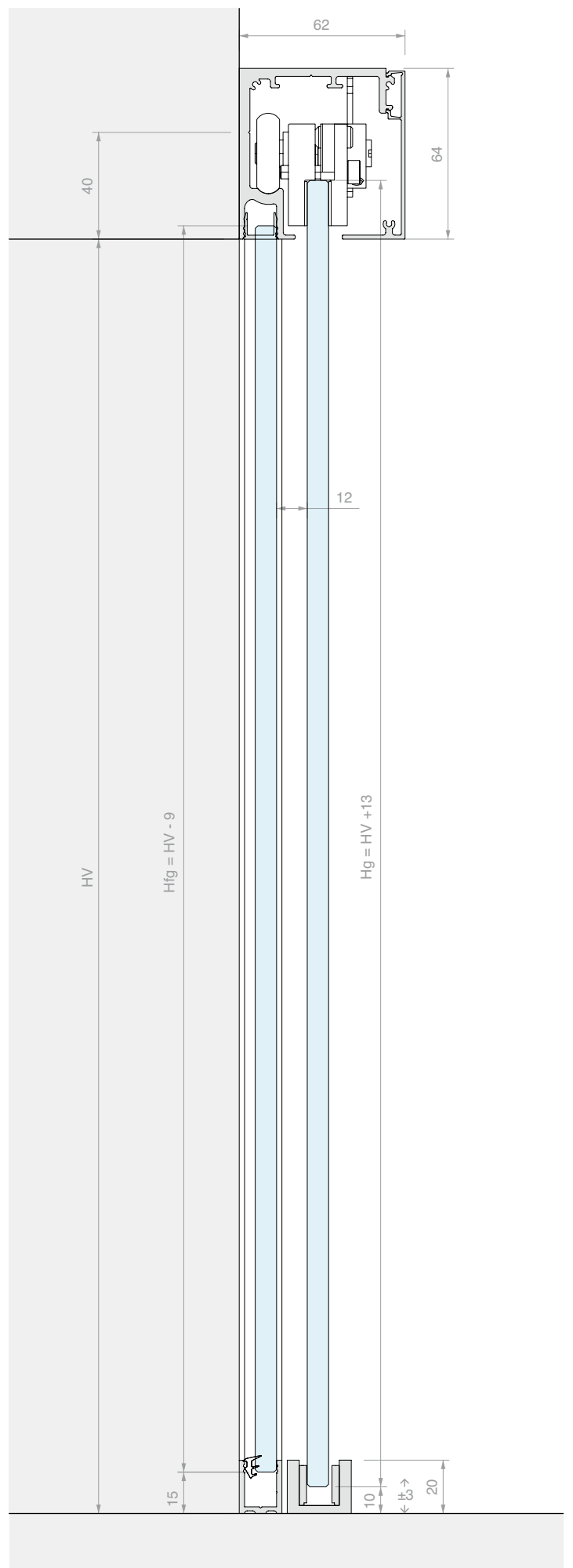
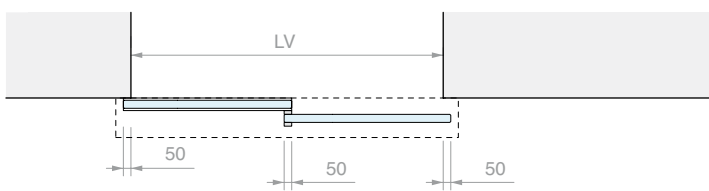
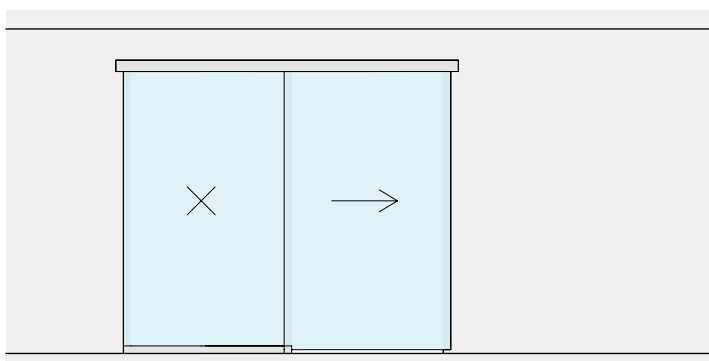
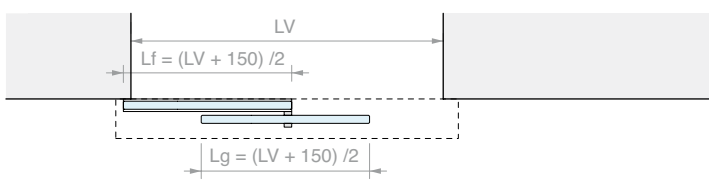
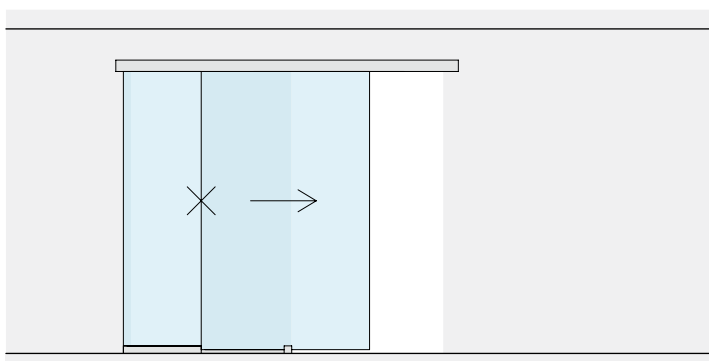
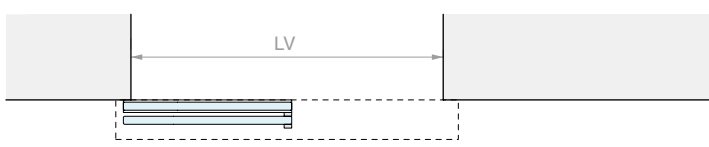
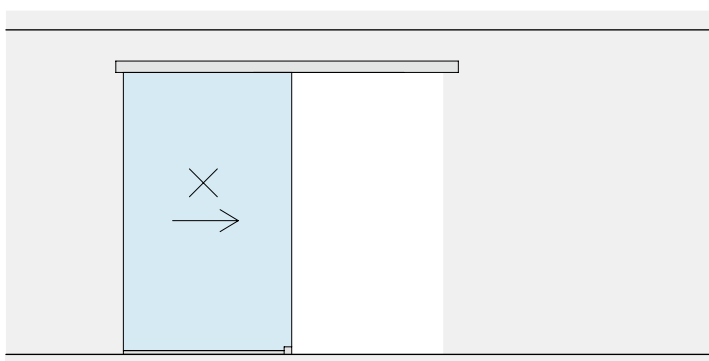



KIT COULISSANT FIXATION MURALE DOUBLE VANTAÏL SYNCHRONISÉ ET DOUBLE VERRE FIXE

Matériau : Aluminium

Finition : /6 /88 /97

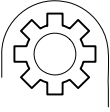
Nouveautés
2025

DIMENSIONS OUVERTURE

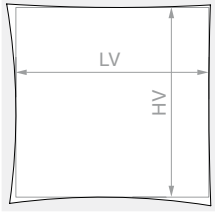

HV max : 3000 mm

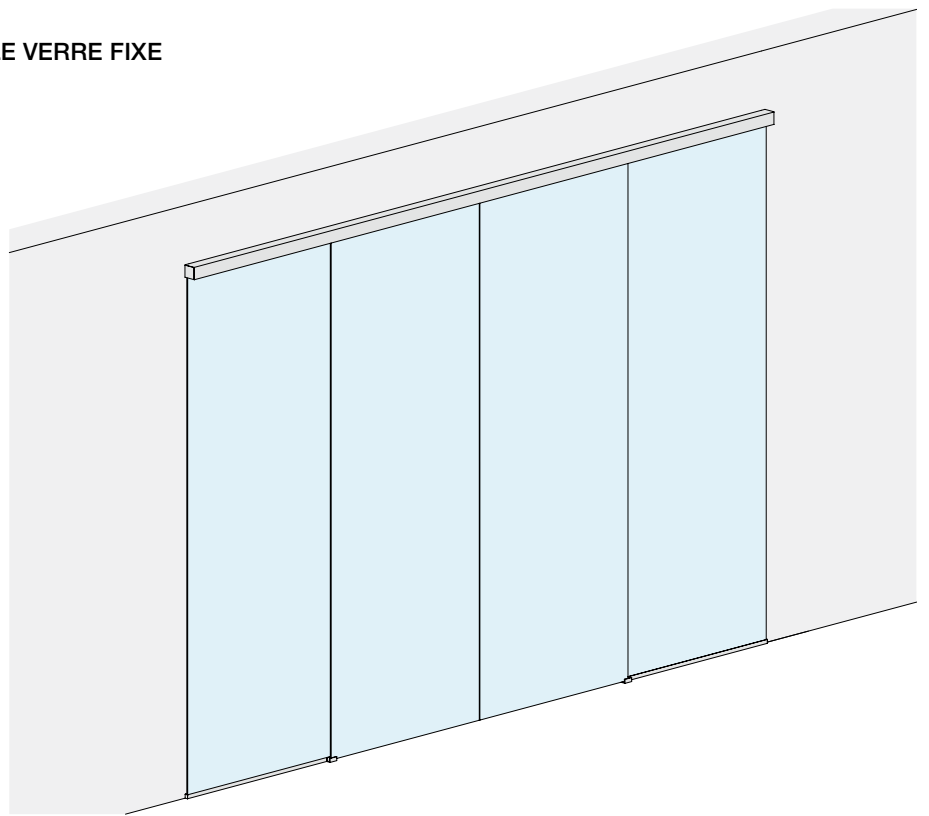

VERRE VANTAÏL

VERRE FIXE

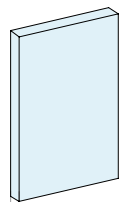

▶ |◀ 8 - 10.8 mm ▶ |◀ 10 - 10.8 mm ▶

Kit composé de :

Réf.	Description	Q.té
LM5864P.400	Rail fixation murale	1 U
LM0064CP.400	Cache pour rail	1 U
LMC13.200	Profil de finition	1 U
LMU20.300	Profil en « U »	1 U
LM63061TP33	Embout de finition	2 U
LMU20TP	Embout de finition	4 U
CERPOS162	Pince	4 U
LMPS-STP55	Butée sans arrêt	4 U
GTUP2	Joint pour fixation du verre	10 m
LMGF	Guide au sol	2 U
LMSIN-AC55	Kit de synchronisme	1 U
En option		
LMDMP100ZKIT	Kit amortisseur de 35-50 kg à double action	1 U

Réf.	LV max	Q.té
LMP6521CFP.400	3880 mm	1 U

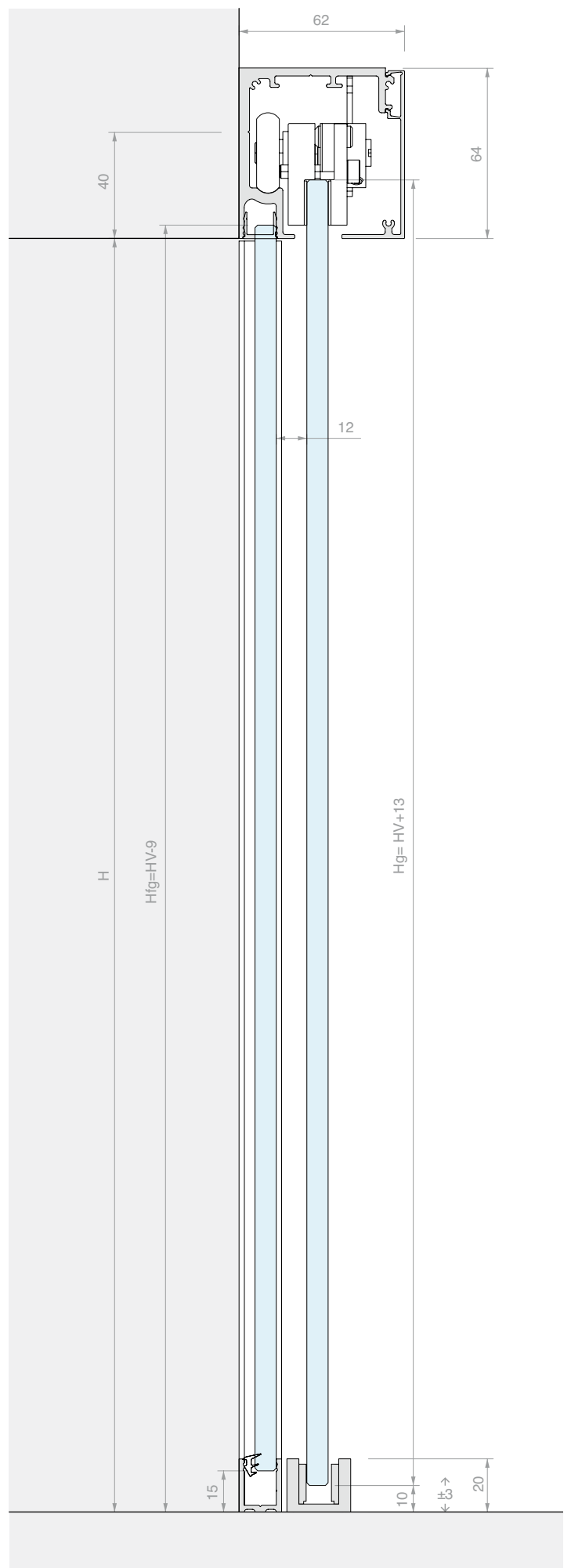
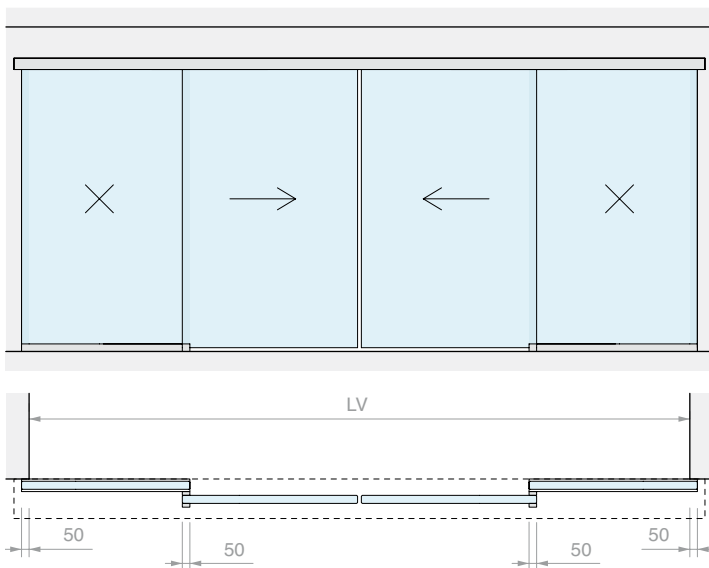
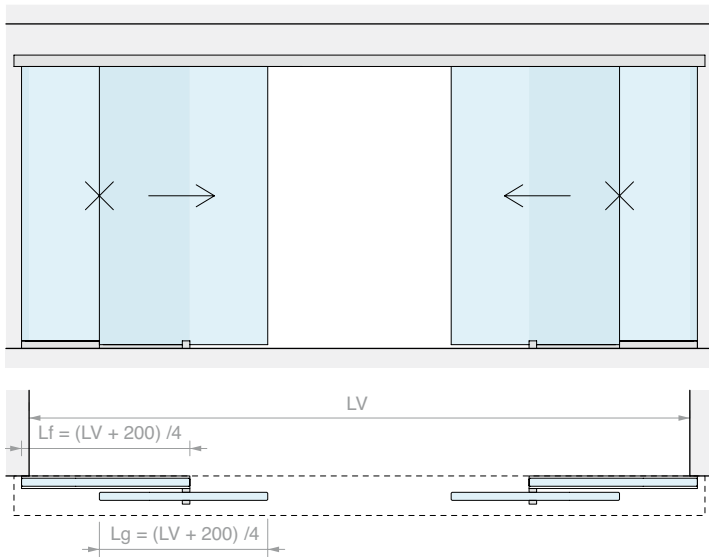
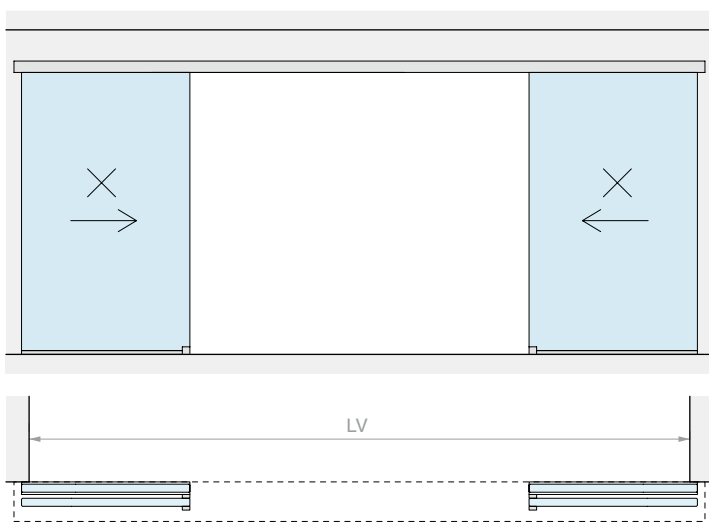



RAIL FIXATION AU PLAFOND

Matériau : Aluminium

Finition : /6 /88 /97

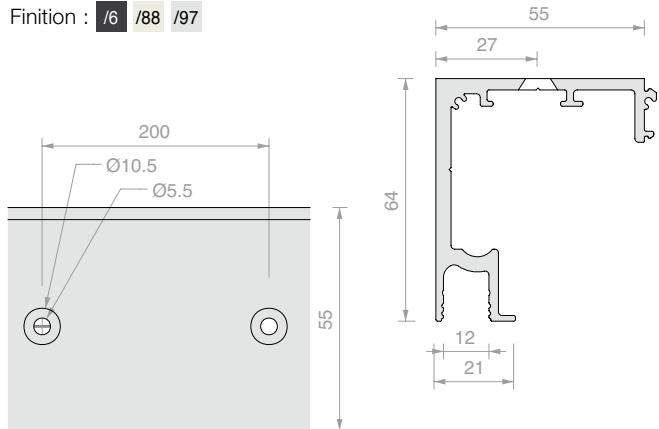

Réf.	Longueur	Q.té
LM5864S.200	1998 mm	1 U
LM5864S.300	2998 mm	1 U
LM5864S.400	3998 mm	1 U
LM5864S.600	6000 mm	1 U



RAIL FIXATION MURALE

Matériau : Aluminium

Finition : /6 /88 /97

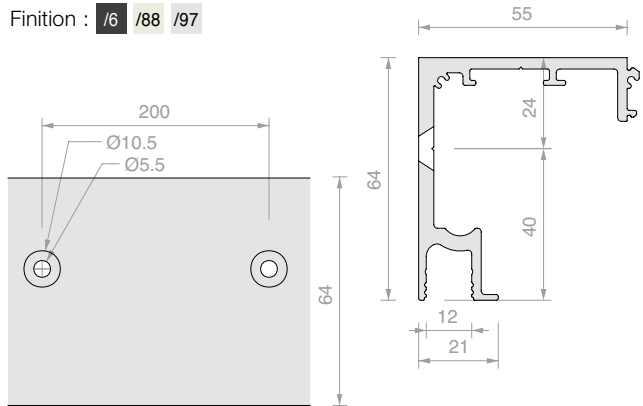

Réf.	Longueur	Q.té
LM5864P.200	1998 mm	1 U
LM5864P.300	2998 mm	1 U
LM5864P.400	3998 mm	1 U
LM5864P.600	6000 mm	1 U



CACHE POUR RAIL

Matériau : Aluminium

Finition : /6 /88 /97

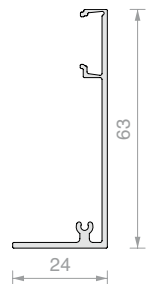

Réf.	Longueur	Q.té
LM0064CP.200	1998 mm	1 U
LM0064CP.300	2998 mm	1 U
LM0064CP.400	3998 mm	1 U
LM0064CP.600	6000 mm	1 U

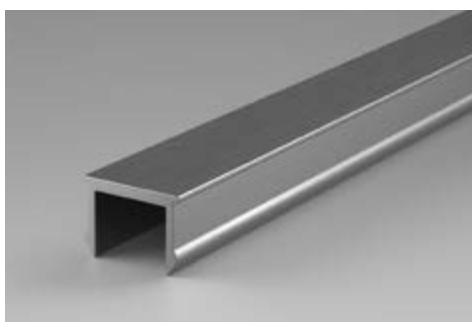

PROFIL DE FINITION

Matériau : Aluminium

Finition : /6 /88 /97

Réf.	Longueur	Q.té
LMC13.100	996 mm	1 U
LMC13.150	1498 mm	1 U
LMC13.200	1998 mm	1 U
LMC13.300	3000 mm	1 U

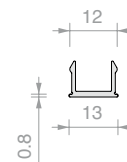

PROFIL EN « U »

Matériau : Aluminium

Finition : /6 /88 /91 /97

Réf.	Longueur	Q.té
LMU20.100	996 mm	1 U
LMU20.150	1498 mm	1 U
LMU20.300	3000 mm	1 U

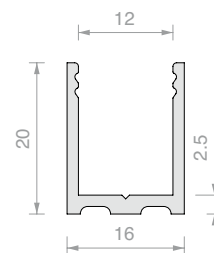

EMBOUT DE FINITION

Matériau : Aluminium

Finition : /88 /91 /97 /R2

Réf.	Q.té
LMU20TP	1 U

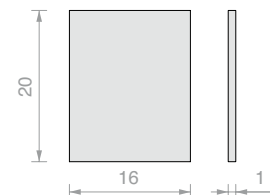

JOINT FIXATION VERRE

Matériau : PVC

Réf.	Épaisseur	Couleur	Q.té	Réf.	Épaisseur	Couleur	Q.té	Réf.	Épaisseur	Couleur	Q.té
GTUP2	2 mm	Transparent	1 m	GTUP2G	2 mm	Gaufrée	1 m	GTUP2N	2 mm	Noir	1 m
GTUP3	3 mm	Transparent	1 m	GTUP3G	3 mm	Gaufrée	1 m	GTUP3N	3 mm	Noir	1 m
GTUP4	4 mm	Transparent	1 m	GTUP4G	4 mm	Gaufrée	1 m	GTUP4N	4 mm	Noir	1 m
GTUP5	5 mm	Transparent	1 m	GTUP5G	5 mm	Gaufrée	1 m	GTUP5N	5 mm	Noir	1 m
GTUP6	6 mm	Transparent	1 m	GTUP6G	6 mm	Gaufrée	1 m	GTUP6N	6 mm	Noir	1 m



EMBOUT DE FINITION 3 VIS

Matériau : Aluminium

Montage côté droit et côté gauche.

Finition : /6 /88 /97

Réf.	Q.té
LM63061TP33	1 U

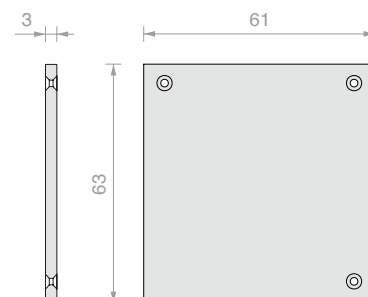



PINCE RÉGLABLE AVEC ROUE

Matériau : Aluminium et inox

Réf.	Pour verres	Q.té
CERPOS162	De 8 à 10.8 mm	1 U



BUTÉE SANS ARRÊT

Matériau : Zamak

Réf.	Q.té
LMPS-STP55	1 U



GUIDE AU SOL

Matériau : Aluminium

Finition : /88 /97 /R2

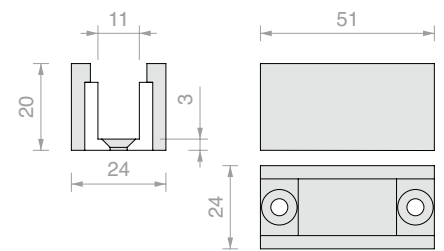

Réf.	Pour verres	Q.té
LMGF	De 8 à 10.8 mm	1 U



KIT COMPLET AMORTISSEUR SOFTBREAK À DOUBLE ACTION

Matériau : POM, Aluminium, Zamak

Permet d'amortir l'ouverture et la fermeture

Réf.	Capacité	Q.té
LMDMP070ZKIT	De 40 à 70 kg	1 U
LMDMP100ZKIT	De 70 à 100 kg	1 U

**AMORTISSEUR SOFTBREAK À DOUBLE ACTION**

Matériau : POM

Permet d'amortir l'ouverture et la fermeture

Pour l'utilisation de l'amortisseur est nécessaire l'utilisation d'une pince de support et de 1 ou 2 activateurs en fonction du côté à amortir

Réf.	Capacité	Q.té
LMDMP070Z	De 40 à 70 kg	1 U
LMDMP100Z	De 70 à 100 kg	1 U

**PINCE DE SUPPORT POUR AMORTISSEUR**

Matériau : Aluminium

Réf.	Q.té
LMPs-PSD62	1 U

**ACTIVATEUR POUR AMORTISSEUR**

Matériau : Zamak

Réf.	Q.té
LMSIN-GA55	1 U

**KIT DE SYNCHRONISME**

Réf.	Q.té
LMSIN-AC55	1 U

Forme

Profils de petite taille pour la décoration des vantaux en verre.

Application sur le verre au moyen d'un adhésif double face de 0.5 mm d'épaisseur, de silicone ou de collage UV.

Choisir le guide et les accessoires appropriés pour loger le verre et son profil de bordure.





PROFIL PLAT GAMME « FORME »

Matériau : Aluminium

Finition : /6 /88 /97 /RAL

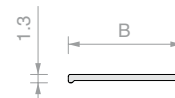

Réf.	B	Longueur	Q.té
FOP10.30	10 mm	3000 mm	1 U
FOP15.30	15 mm	3000 mm	1 U
FOP20.30	20 mm	3000 mm	1 U



PROFIL EN « U » GAMME « FORME »

Matériau : Aluminium

Finition : /6 /88 /97 /RAL

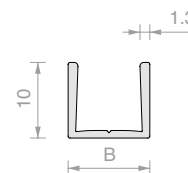

Réf.	B	Longueur	Pour verres	Q.té
FOU1011.30	10.8 mm	3000 mm	8 mm	1 U
FOU1013.30	12.8 mm	3000 mm	10 mm	1 U



ADHÉSIF DOUBLE FACE TESA® ACX^{plus}

Adhésif double face transparent pour fixations de verre, inox et aluminium.

La bande de papier facilite l'application manuelle du ruban.

Réf.	Dimensions	Épaisseur	Q.té
TS250065	6 mm x 25 m	0.5 mm	1 U
TS250125	12 mm x 25 m	0.5 mm	1 U
TS250155	15 mm x 25 m	0.5 mm	1 U



GUIDE AU SOL

Matériau : Aluminium

Finition : /88 /97 /R2

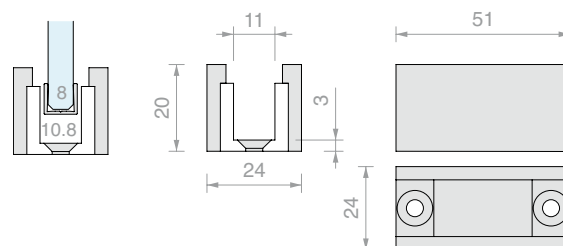

Réf.	Pour profil	Q.té
LMGF	FOU1011	1 U



ADAPTATEUR POUR GUIDE LMGF



Accessoire à insérer dans le guide au sol LMGF

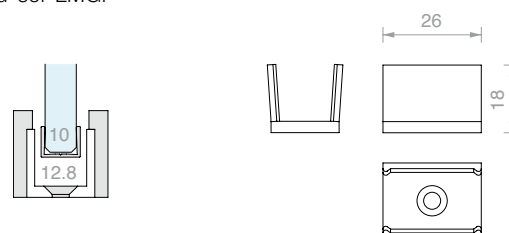

Matériau : plastique



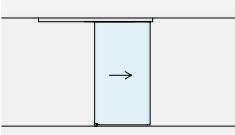
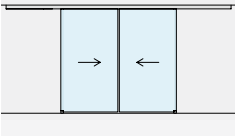
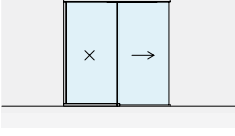
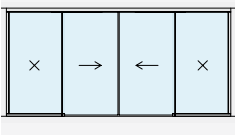
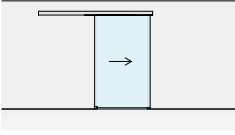

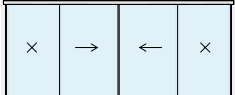

Finition : /56

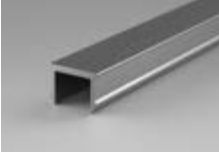



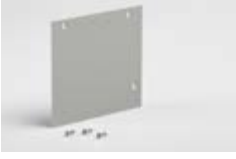







Réf.	Pour profil	Q.té
LMGF13-POM	FOU1013	1 U

	Réf.	Description	Finition	Q.té	EURO
Kit coulissant LM PORTA PRO					
	LMP6511P.200/6	Fixation au plafond simple vantail Lvmax 920	Noir mat	1 U	587,07
	LMP6511P.200/88	Fixation au plafond simple vantail Lvmax 920	Aluminium effet inox brossé	1 U	578,78
	LMP6511P.200/97	Fixation au plafond simple vantail Lvmax 920	Aluminium mat	1 U	560,14
	LMP6511P.300/6	Fixation au plafond simple vantail Lvmax 1420	Noir mat	1 U	663,21
	LMP6511P.300/88	Fixation au plafond simple vantail Lvmax 1420	Aluminium effet inox brossé	1 U	653,66
	LMP6511P.300/97	Fixation au plafond simple vantail Lvmax 1420	Aluminium mat	1 U	630,06
	LMP6511CP.400/6	Fixation au plafond double vantail synchronisé Lvmax 1940	Noir mat	1 U	1.202,28
	LMP6511CP.400/88	Fixation au plafond double vantail synchronisé Lvmax 1940	Aluminium effet inox brossé	1 U	1.182,85
	LMP6511CP.400/97	Fixation au plafond double vantail synchronisé Lvmax 1940	Aluminium mat	1 U	1.156,91
	LMP6511FP.200/6	Fixation au plafond simple vantail et verre fixe Lvmax 2000	Noir mat	1 U	649,31
	LMP6511FP.200/88	Fixation au plafond simple vantail et verre fixe Lvmax 2000	Aluminium effet inox brossé	1 U	610,04
	LMP6511FP.200/97	Fixation au plafond simple vantail et verre fixe Lvmax 2000	Aluminium mat	1 U	599,39
	LMP6511FP.300/6	Fixation au plafond simple vantail et verre fixe Lvmax 3000	Noir mat	1 U	764,87
	LMP6511FP.300/88	Fixation au plafond simple vantail et verre fixe Lvmax 3000	Aluminium effet inox brossé	1 U	696,89
	LMP6511FP.300/97	Fixation au plafond simple vantail et verre fixe Lvmax 3000	Aluminium mat	1 U	679,16
	LMP6511CFP.400/6	Fixation plafond dble vantail synchro et dble verre fixe Lvmax 4000	Noir mat	1 U	1.314,74
	LMP6511CFP.400/88	Fixation plafond dble vantail synchro et dble verre fixe Lvmax 4000	Aluminium effet inox brossé	1 U	1.236,22
	LMP6511CFP.400/97	Fixation plafond dble vantail synchro et dble verre fixe Lvmax 4000	Aluminium mat	1 U	1.214,91
	LMP6521P.200/6	Fixation murale simple vantail Lvmax 920	Noir mat	1 U	587,07
	LMP6521P.200/88	Fixation murale simple vantail Lvmax 920	Aluminium effet inox brossé	1 U	578,78
	LMP6521P.200/97	Fixation murale simple vantail Lvmax 920	Aluminium mat	1 U	560,14
	LMP6521P.300/6	Fixation murale simple vantail Lvmax 1420	Noir mat	1 U	663,21
	LMP6521P.300/88	Fixation murale simple vantail Lvmax 1420	Aluminium effet inox brossé	1 U	653,66
	LMP6521P.300/97	Fixation murale simple vantail Lvmax 1420	Aluminium mat	1 U	630,06
	LMP6521CP.400/6	Fixation murale double vantail synchronisé Lvmax 1940	Noir mat	1 U	1.202,28
	LMP6521CP.400/88	Fixation murale double vantail synchronisé Lvmax 1940	Aluminium effet inox brossé	1 U	1.182,85
	LMP6521CP.400/97	Fixation murale double vantail synchronisé Lvmax 1940	Aluminium mat	1 U	1.156,91
	LMP6521FP.200/6	Fixation murale simple vantail et verre fixe Lvmax 1880	Noir mat	1 U	679,69
	LMP6521FP.200/88	Fixation murale simple vantail et verre fixe Lvmax 1880	Aluminium effet inox brossé	1 U	643,26
	LMP6521FP.200/97	Fixation murale simple vantail et verre fixe Lvmax 1880	Aluminium mat	1 U	621,28
	LMP6521FP.300/6	Fixation murale simple vantail et verre fixe Lvmax 2880	Noir mat	1 U	795,26
	LMP6521FP.300/88	Fixation murale simple vantail et verre fixe Lvmax 2880	Aluminium effet inox brossé	1 U	730,11
	LMP6521FP.300/97	Fixation murale simple vantail et verre fixe Lvmax 2880	Aluminium mat	1 U	701,07
	LMP6521CFP.400/6	Fixation murale dble vantail synchro et dble verre fixe Lvmax 3880	Noir mat	1 U	1.345,12
	LMP6521CFP.400/88	Fixation murale dble vantail synchro et dble verre fixe Lvmax 3880	Aluminium effet inox brossé	1 U	1.269,44
	LMP6521CFP.400/97	Fixation murale dble vantail synchro et dble verre fixe Lvmax 3880	Aluminium mat	1 U	1.236,80

	Réf.	Description	Finition	Q.té	EURO
	LM5864S.200/6	Rail de fixation au plafond, B55 H64 L1998	Noir mat	1 U	167,60
	LM5864S.200/88	Rail de fixation au plafond, B55 H64 L1998	Aluminium effet inox brossé	1 U	165,22
	LM5864S.200/97	Rail de fixation au plafond, B55 H64 L1998	Aluminium mat	1 U	155,74
	LM5864S.300/6	Rail de fixation au plafond, B55 H64 L2998	Noir mat	1 U	242,13
	LM5864S.300/88	Rail de fixation au plafond, B55 H64 L2998	Aluminium effet inox brossé	1 U	238,57
	LM5864S.300/97	Rail de fixation au plafond, B55 H64 L2998	Aluminium mat	1 U	224,36
	LM5864S.400/6	Rail de fixation au plafond, B55 H64 L3998	Noir mat	1 U	316,67
	LM5864S.400/88	Rail de fixation au plafond, B55 H64 L3998	Aluminium effet inox brossé	1 U	311,92
	LM5864S.400/97	Rail de fixation au plafond, B55 H64 L3998	Aluminium mat	1 U	293,00
	LM5864S.600/6	Rail de fixation au plafond, B55 H64 L6000	Noir mat	1 U	448,80
	LM5864S.600/88	Rail de fixation au plafond, B55 H64 L6000	Aluminium effet inox brossé	1 U	441,67
	LM5864S.600/97	Rail de fixation au plafond, B55 H64 L6000	Aluminium mat	1 U	413,27
	LM5864P.200/6	Rail de fixation murale, B55 H64 L1998	Noir mat	1 U	167,60
	LM5864P.200/88	Rail de fixation murale, B55 H64 L1998	Aluminium effet inox brossé	1 U	165,22
	LM5864P.200/97	Rail de fixation murale, B55 H64 L1998	Aluminium mat	1 U	155,74
	LM5864P.300/6	Rail de fixation murale, B55 H64 L2998	Noir mat	1 U	242,13
	LM5864P.300/88	Rail de fixation murale, B55 H64 L2998	Aluminium effet inox brossé	1 U	238,57
	LM5864P.300/97	Rail de fixation murale, B55 H64 L2998	Aluminium mat	1 U	224,36
	LM5864P.400/6	Rail de fixation murale, B55 H64 L3998	Noir mat	1 U	316,67
	LM5864P.400/88	Rail de fixation murale, B55 H64 L3998	Aluminium effet inox brossé	1 U	311,92
	LM5864P.400/97	Rail de fixation murale, B55 H64 L3998	Aluminium mat	1 U	293,00
	LM5864P.600/6	Rail de fixation murale, B55 H64 L6000	Noir mat	1 U	448,80
	LM5864P.600/88	Rail de fixation murale, B55 H64 L6000	Aluminium effet inox brossé	1 U	441,67
	LM5864P.600/97	Rail de fixation murale, B55 H64 L6000	Aluminium mat	1 U	413,27
	LM0064CP.200/6	Cache pour rail, B25.7 H63 L1998	Noir mat	1 U	52,14
	LM0064CP.200/88	Cache pour rail, B25.7 H63 L1998	Aluminium effet inox brossé	1 U	51,52
	LM0064CP.200/97	Cache pour rail, B25.7 H63 L1998	Aluminium mat	1 U	49,06
	LM0064CP.300/6	Cache pour rail, B25.7 H63 L2998	Noir mat	1 U	68,97
	LM0064CP.300/88	Cache pour rail, B25.7 H63 L2998	Aluminium effet inox brossé	1 U	68,02
	LM0064CP.300/97	Cache pour rail, B25.7 H63 L2998	Aluminium mat	1 U	64,33
	LM0064CP.400/6	Cache pour rail, B25.7 H63 L3998	Noir mat	1 U	85,78
	LM0064CP.400/88	Cache pour rail, B25.7 H63 L3998	Aluminium effet inox brossé	1 U	84,55
	LM0064CP.400/97	Cache pour rail, B25.7 H63 L3998	Aluminium mat	1 U	79,62
	LM0064CP.600/6	Cache pour rail, B25.7 H63 L6000	Noir mat	1 U	102,45
	LM0064CP.600/88	Cache pour rail, B25.7 H63 L6000	Aluminium effet inox brossé	1 U	100,61
	LM0064CP.600/97	Cache pour rail, B25.7 H63 L6000	Aluminium mat	1 U	93,21
	LMC13.100/6	Profil de finition, L996	Noir mat	1 U	14,87
	LMC13.100/88	Profil de finition, L996	Aluminium effet inox brossé	1 U	14,45
	LMC13.100/97	Profil de finition, L996	Aluminium mat	1 U	14,06
	LMC13.150/6	Profil de finition, L1498	Noir mat	1 U	18,30
	LMC13.150/88	Profil de finition, L1498	Aluminium effet inox brossé	1 U	17,69
	LMC13.150/97	Profil de finition, L1498	Aluminium mat	1 U	17,09
	LMC13.200/6	Profil de finition, L1998	Noir mat	1 U	19,18
	LMC13.200/88	Profil de finition, L1998	Aluminium effet inox brossé	1 U	18,44
	LMC13.200/97	Profil de finition, L1998	Aluminium mat	1 U	17,75
	LMC13.300/6	Profil de finition, L3000	Noir mat	1 U	20,28

	Réf.	Description	Finition	Q.té	EURO
	LMC13.300/88	Profil de finition, L3000	Aluminium effet inox brossé	1 U	19,05
	LMC13.300/97	Profil de finition, L3000	Aluminium mat	1 U	17,95
	LMU20.100/6	Profil en « U », B16 H20 L996	Noir mat	1 U	35,35
	LMU20.100/88	Profil en « U », B16 H20 L996	Aluminium effet inox brossé	1 U	31,02
	LMU20.100/91	Profil en « U », B16 H20 L996	Aluminium brillant	1 U	32,85
	LMU20.100/97	Profil en « U », B16 H20 L996	Aluminium mat	1 U	29,48
	LMU20.150/6	Profil en « U », B16 H20 L1498	Noir mat	1 U	48,40
	LMU20.150/88	Profil en « U », B16 H20 L1498	Aluminium effet inox brossé	1 U	38,43
	LMU20.150/91	Profil en « U », B16 H20 L1498	Aluminium brillant	1 U	40,19
	LMU20.150/97	Profil en « U », B16 H20 L1498	Aluminium mat	1 U	36,15
	LMU20.300/6	Profil en « U », B16 H20 L3000	Noir mat	1 U	71,28
	LMU20.300/88	Profil en « U », B16 H20 L3000	Aluminium effet inox brossé	1 U	56,06
LMU20.300/91	Profil en « U », B16 H20 L3000	Aluminium brillant	1 U	59,40	
LMU20.300/97	Profil en « U », B16 H20 L3000	Aluminium mat	1 U	51,59	
	LMU20TP/88	Embout de finition, B16 H20 L1	Aluminium effet inox brossé	1 U	6,36
	LMU20TP/91	Embout de finition, B16 H20 L1	Aluminium brillant	1 U	6,36
	LMU20TP/97	Embout de finition, B16 H20 L1	Aluminium mat	1 U	6,25
	LMU20TP/R2	Embout de finition, B16 H20 L1	RAL 9005 Noir mat	1 U	7,70
	GTUP2	Joint fixation verre, H2	Transparent	1 m	1,21
	GTUP3	Joint fixation verre, H3	Transparent	1 m	1,39
	GTUP4	Joint fixation verre, H4	Transparent	1 m	1,69
	GTUP5	Joint fixation verre, H5	Transparent	1 m	2,35
	GTUP6	Joint fixation verre, H6	Transparent	1 m	3,30
	GTUP2G	Joint fixation verre, H2	Gaufré	1 m	1,80
	GTUP3G	Joint fixation verre, H3	Gaufré	1 m	2,02
	GTUP4G	Joint fixation verre, H4	Gaufré	1 m	2,29
	GTUP5G	Joint fixation verre, H5	Gaufré	1 m	2,60
	GTUP6G	Joint fixation verre, H6	Gaufré	1 m	3,81
	GTUP2N	Joint fixation verre, H2	Noir	1 m	1,21
	GTUP3N	Joint fixation verre, H3	Noir	1 m	1,39
	GTUP4N	Joint fixation verre, H4	Noir	1 m	1,69
	GTUP5N	Joint fixation verre, H5	Noir	1 m	2,35
GTUP6N	Joint fixation verre, H6	Noir	1 m	3,30	
	LM63061TP33/6	Embout de finition avec 3 vis, B61 H63	Noir mat	1 U	24,68
	LM63061TP33/88	Embout de finition avec 3 vis, B61 H63	Aluminium effet inox brossé	1 U	24,68
	LM63061TP33/97	Embout de finition avec 3 vis, B61 H63	Aluminium mat	1 U	23,17
	CERPOS162	Pince pour portes coulissantes réglable avec roue, pour verres 8/10.8		1 U	146,74
	LMPS-STP55	Butée sans arrêt		1 U	18,83
	LMGF/88	Guide au sol, pour verres 8/10.8, B25 H23 L46	Aluminium effet inox brossé	1 U	26,31
	LMGF/97	Guide au sol, pour verres 8/10.8, B25 H23 L46	Aluminium mat	1 U	26,31
	LMGF/R2	Guide au sol, pour verres 8/10.8, B25 H23 L46	RAL 9005 Noir mat	1 U	31,59

	Réf.	Description	Finition	Q.té	EURO
	LMDMP070ZKIT	Kit complet amortisseur softbreak à double action de 40 à 70 kg		1 U	121,68
	LMDMP100ZKIT	Kit complet amortisseur softbreak à double action de 70 à 100 kg		1 U	121,68
	LMDMP070Z	Amortisseur softbreak à double action de 40 à 70 kg		1 U	67,54
	LMDMP100Z	Amortisseur softbreak à double action de 70 à 100 kg		1 U	67,54
	LMPS-PSD62	Pince de support pour amortisseur		1 U	21,19
	LMSIN-GA55	Activateur pour amortisseur		1 U	16,48
	LMSIN-AC55	Kit de synchronisme		1 U	133,54
	FOP10.30/6	Profil plat gamme FORME, B10 H1.3 L3000	Noir mat	1 U	33,32
	FOP10.30/88	Profil plat gamme FORME, B10 H1.3 L3000	Aluminium effet inox brossé	1 U	33,32
	FOP10.30/97	Profil plat gamme FORME, B10 H1.3 L3000	Aluminium mat	1 U	25,00
	FOP10.30/RAL	Profil plat gamme FORME, B10 H1.3 L3000	RAL 9010 Blanc brillant	1 U	29,16
	FOP15.30/6	Profil plat gamme FORME, B15 H1.3 L3000	Noir mat	1 U	35,34
	FOP15.30/88	Profil plat gamme FORME, B15 H1.3 L3000	Aluminium effet inox brossé	1 U	35,34
	FOP15.30/97	Profil plat gamme FORME, B15 H1.3 L3000	Aluminium mat	1 U	27,02
	FOP15.30/RAL	Profil plat gamme FORME, B15 H1.3 L3000	RAL 9010 Blanc brillant	1 U	31,18
	FOP20.30/6	Profil plat gamme FORME, B20 H1.3 L3000	Noir mat	1 U	37,98
	FOP20.30/88	Profil plat gamme FORME, B20 H1.3 L3000	Aluminium effet inox brossé	1 U	37,98
	FOP20.30/97	Profil plat gamme FORME, B20 H1.3 L3000	Aluminium mat	1 U	29,68
	FOP20.30/RAL	Profil plat gamme FORME, B20 H1.3 L3000	RAL 9010 Blanc brillant	1 U	33,82
	FOU1011.30/6	Profil plat en « U » gamme FORME, pour verres 8, B10.8 H10 L3000	Noir mat	1 U	47,24
	FOU1011.30/88	Profil plat en « U » gamme FORME, pour verres 8, B10.8 H10 L3000	Aluminium effet inox brossé	1 U	47,24
	FOU1011.30/97	Profil plat en « U » gamme FORME, pour verres 8, B10.8 H10 L3000	Aluminium mat	1 U	38,92
	FOU1011.30/RAL	Profil plat en « U » gamme FORME, pour verres 8, B10.8 H10 L3000	RAL 9010 Blanc brillant	1 U	43,08
	FOU1013.30/6	Profil plat en « U » gamme FORME, pour verres 10, B12.8 H10 L3000	Noir mat	1 U	50,02
	FOU1013.30/88	Profil plat en « U » gamme FORME, pour verres 10, B12.8 H10 L3000	Aluminium effet inox brossé	1 U	50,02
	FOU1013.30/97	Profil plat en « U » gamme FORME, pour verres 10, B12.8 H10 L3000	Aluminium mat	1 U	41,70
FOU1013.30/RAL	Profil plat en « U » gamme FORME, pour verres 10, B12.8 H10 L3000	RAL 9010 Blanc brillant	1 U	45,86	
	TS250065	Ruban adhésif double face Tesa® ACXplus, B6 H0.5 L25m	Transparent	1 U	33,26
	TS250125	Ruban adhésif double face Tesa® ACXplus, B12 H0.5 L25m	Transparent	1 U	66,52
	TS250155	Ruban adhésif double face Tesa® ACXplus, B15 H0.5 L25m	Transparent	1 U	105,50
	LMGF/88	Guide au sol, pour verres 8/10.8, B25 H23 L46	Aluminium effet inox brossé	1 U	26,32
	LMGF/97	Guide au sol, pour verres 8/10.8, B25 H23 L46	Aluminium mat	1 U	26,32
	LMGF/R2	Guide au sol, pour verres 8/10.8, B25 H23 L46	RAL 9005 Noir mat	1 U	31,60
	LMGF13-POM/56	Adaptateur pour guide LMGF	Gris	1 U	7,60



Saint-Gobain Logli S.r.l.
Via Chemnitz, 49/51
59100 Prato - Italie
www.sg-logli.it

