

 **logli**
SAINT-GOBAIN

NUEVO
LM PORTA PRO

Esencial, evolucionado,
sorprendente



SAINT-GOBAIN

LM PORTA PRO

Novedades
2025

Design

Esencial, evolucionado, sorprendente

LM PORTA PRO es un sistema deslizante que combina **diseño limpio, versatilidad proyectual y alto rendimiento técnico.**

Sus líneas cuadradas, proporciones armoniosas y perfiles optimizados se integran perfectamente en cualquier entorno, dando vida a una solución elegante y contemporáneo.

El corazón del sistema son un **perfil compacto de 62 x 64 mm** y una **nueva abrazadera íntegramente en aluminio**, diseñados para garantizar fiabilidad y durabilidad. ¿El resultado? **Rendimiento probado hasta 45.000 ciclos de apertura y cierre**, para uso intensivo y siempre fluido.

La identidad de LM PORTA sigue siendo claramente reconocible:

Fijación a pared o techo

Configuraciones con o sin vidrio fijo

Un solo amortiguador por puerta que garantiza un movimiento suave y silencioso, tanto en la apertura como en el cierre.

LM PORTA PRO

El sistema completo, diseñado para durar.

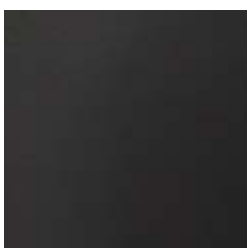
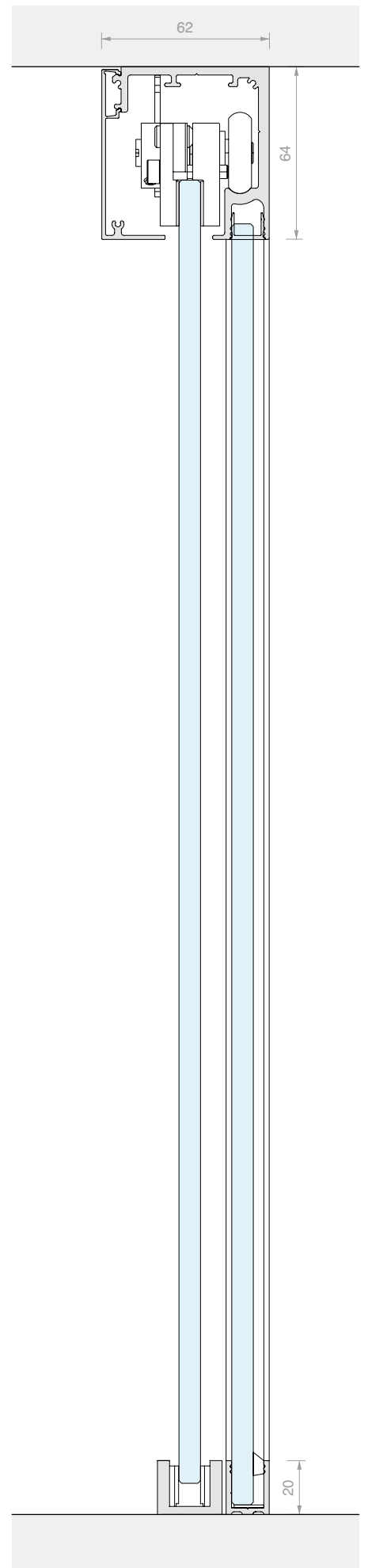

/6
Negro opaco



/88
Aluminio símil-inox satinado

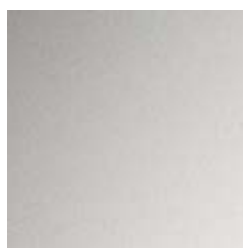

/97
Aluminio opaco

Probado según UNI EN 1527

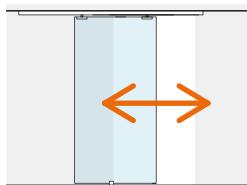

Puertas de 100 kg más de **45.000 ciclos**

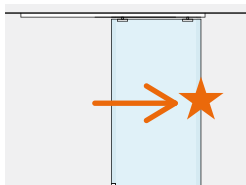

Slam test **GRADO 3** (grado máximo)

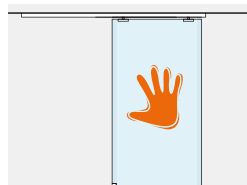

Carga horizontal **GRADO 3** (grado máximo)

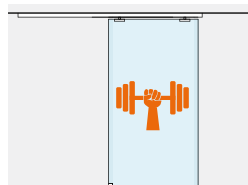

Pasa la prueba de sobrecarga de más de **200 kg**

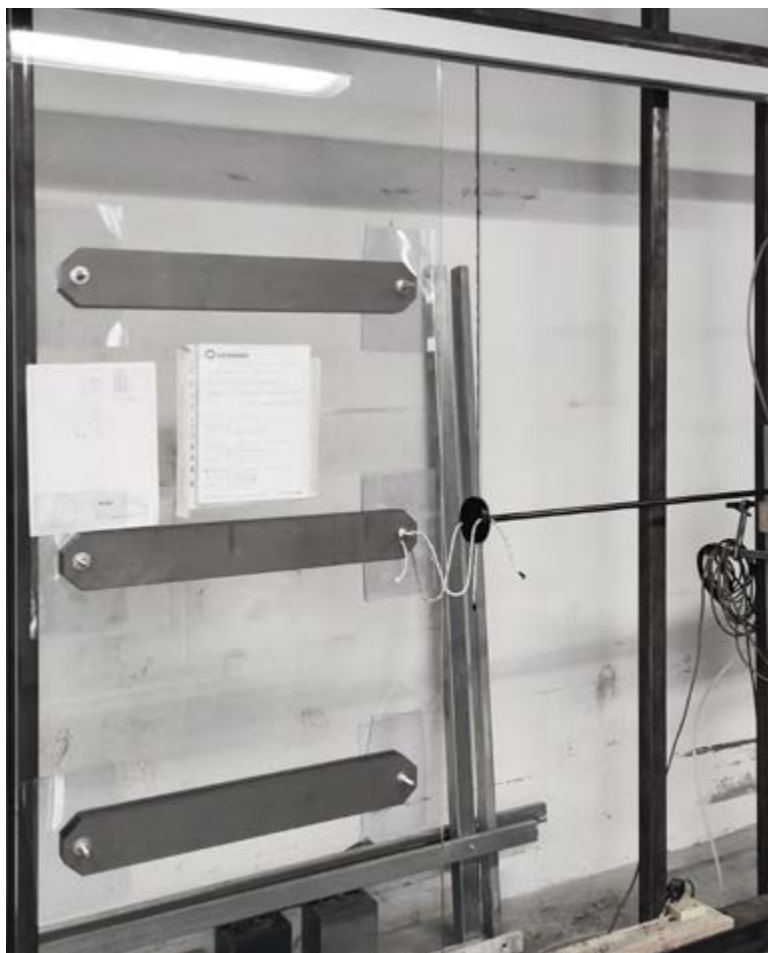

Rendimiento probado hasta 45.000 ciclos de apertura y cierre



Prueba de sobrecarga



Abrazadera íntegramente en aluminio

LM PORTA PRO

Novedades
2025

Características técnicas

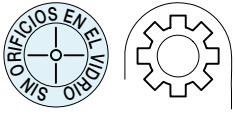

VIDRIO HOJA

VIDRIO FIJO

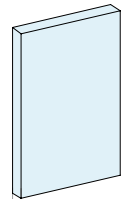

▶ ◀ 8 - 10.8 mm

▶ ◀ 8 - 10.8 mm

2 tipos de instalación

Techo

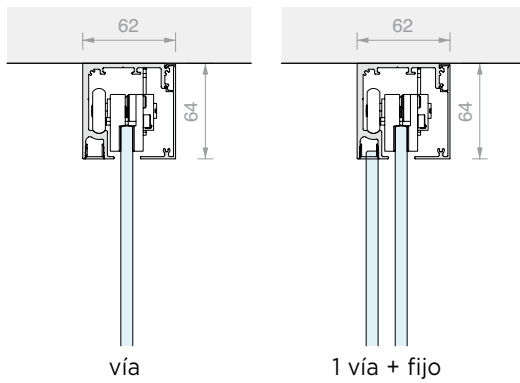

Pared

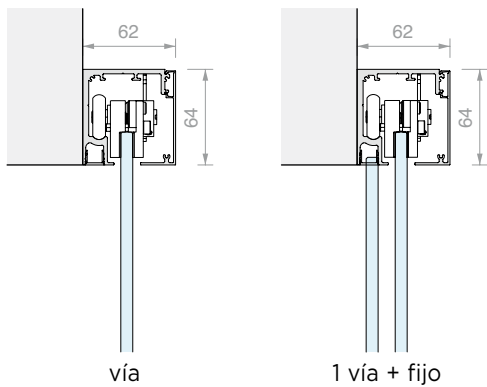

cubierta h = 63mm

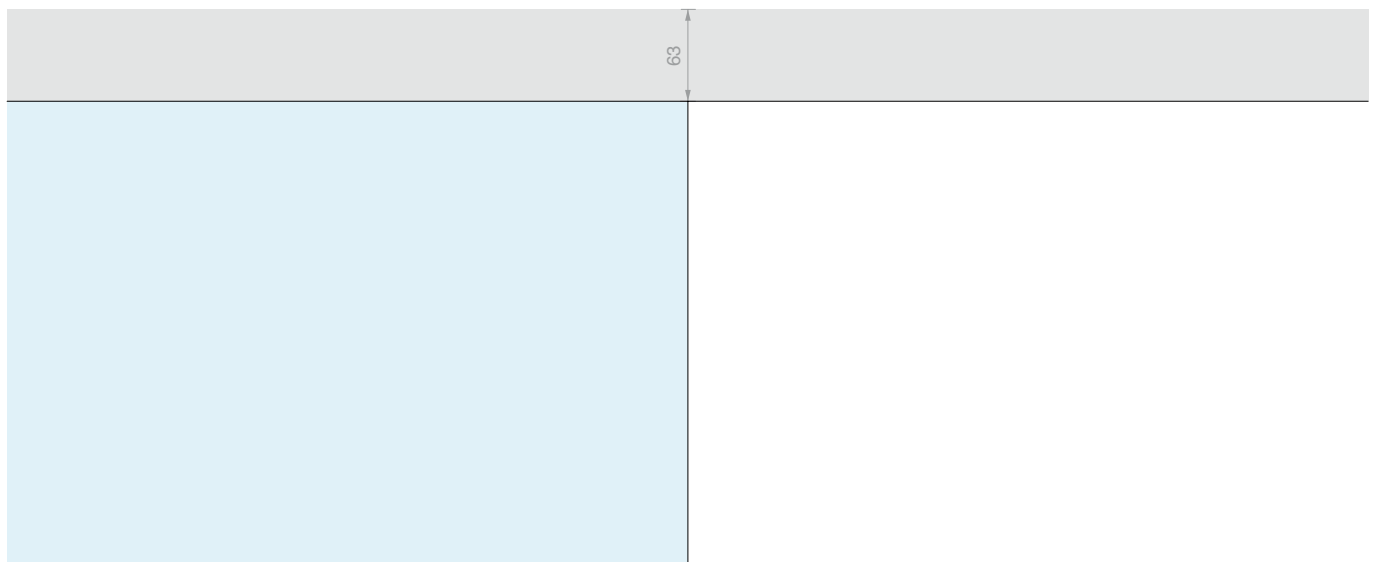

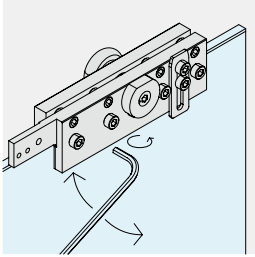
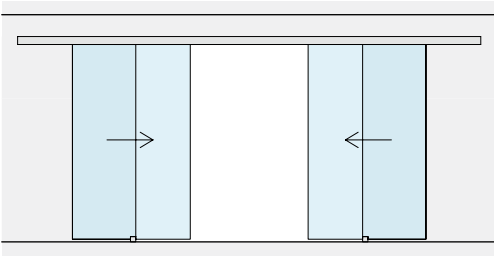

REGULACIÓN DE LA HOJA

Se puede ajustar la altura de cada carro individual para registrar la posición de la hoja en ± 3 mm.

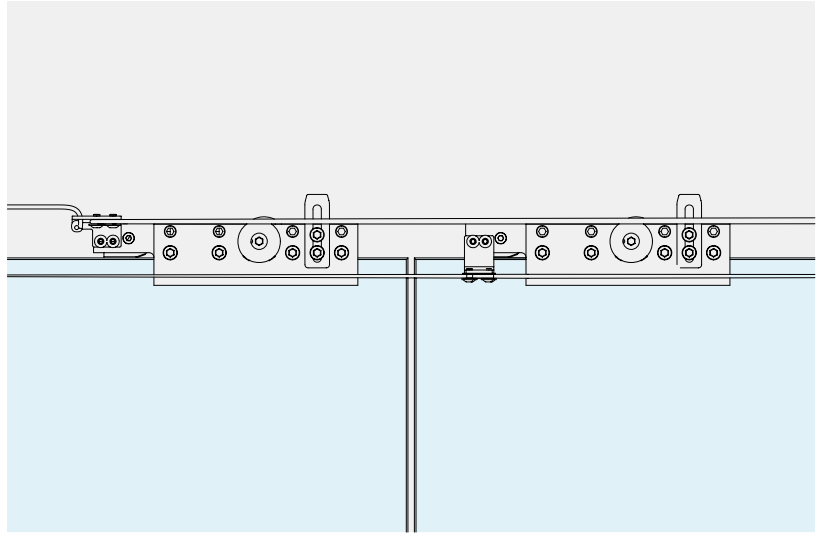

SINCRONISMO

Hay accesorios disponibles para la sincronización simultánea de 2 hojas móviles.

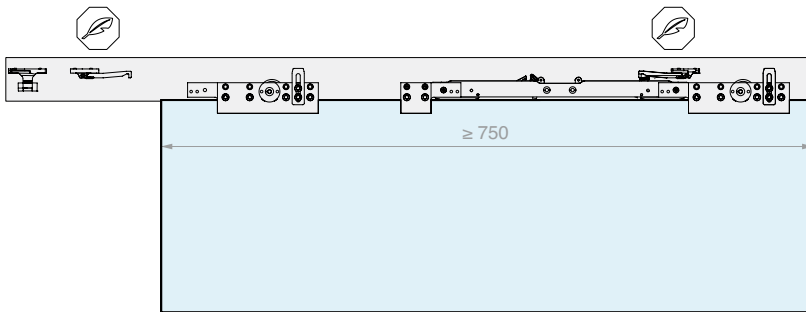

SOFT CLOSE

El uso de un solo amortiguador permite una apertura y un cierre controlados y suaves.

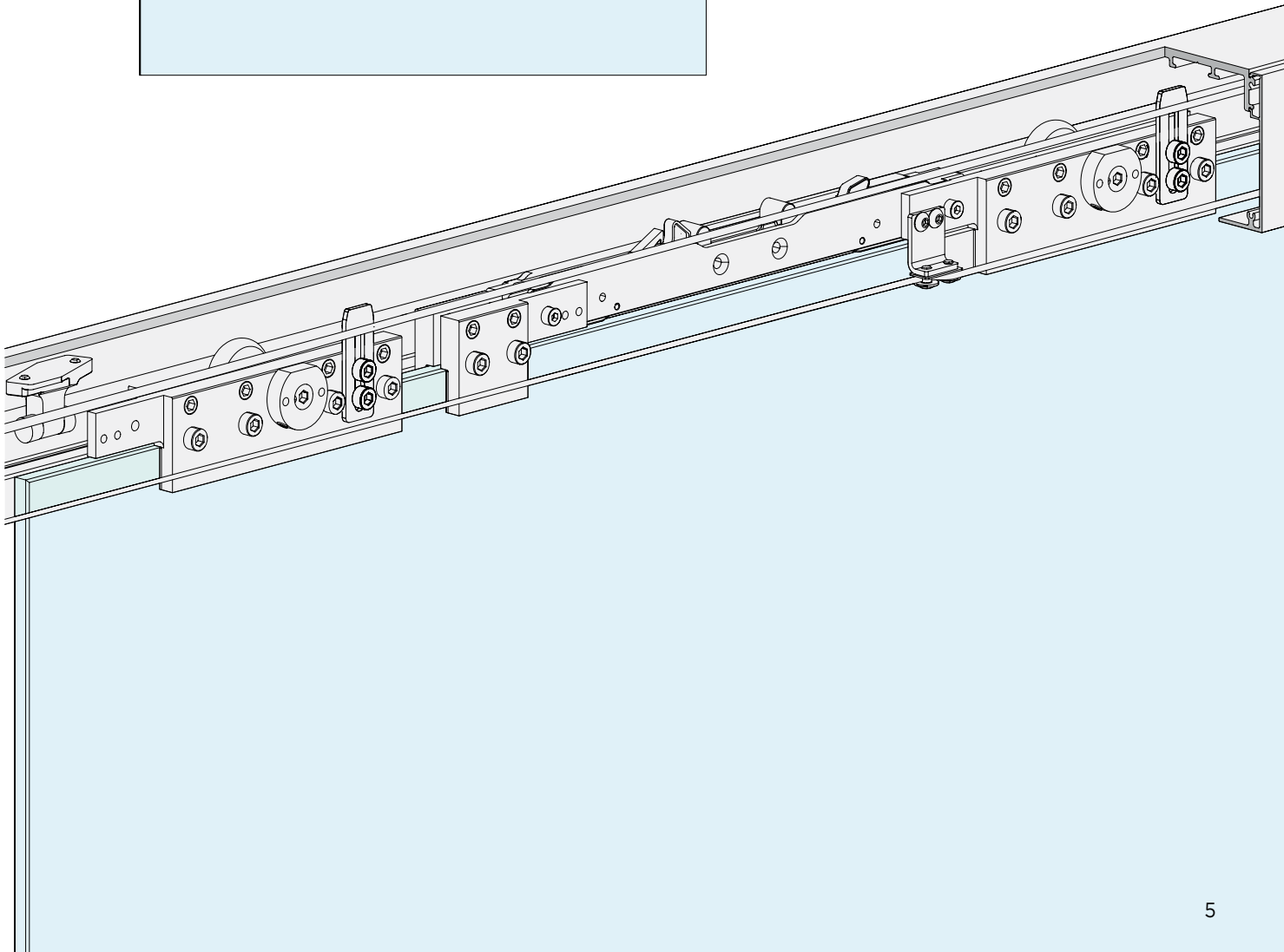



LM PORTA PRO

Kit

INSTALACIÓN DE TECHO

HOJAS MÓVILES

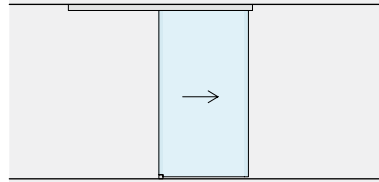

Pág. 8

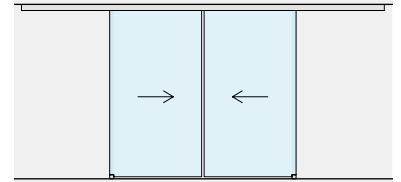

Pág. 12

HOJAS MÓVILES
CON VIDRIOS FIJOS

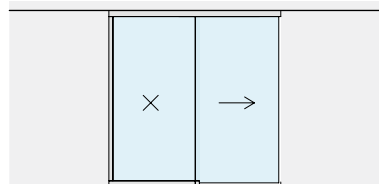

Pág. 16

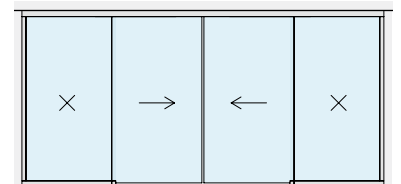

Pág. 20

INSTALACIÓN A PARED

HOJAS MÓVILES

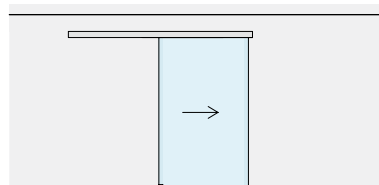

Pág. 24

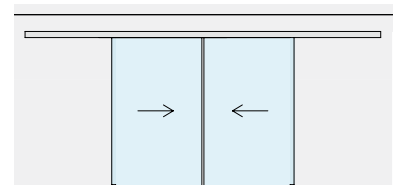

Pág. 26

HOJAS MÓVILES
CON VIDRIOS FIJOS

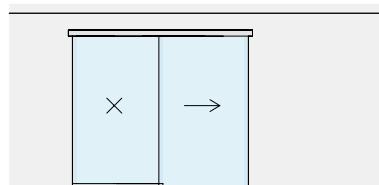

Pág. 30

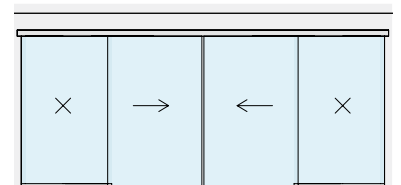

Pág. 32



KIT CORREDERA FIJACIÓN DE TECHO HOJA SIMPLE

Material: Aluminio

Acabado: /6 /88 /97

Novedades
2025

MEDIDAS DEL VANO

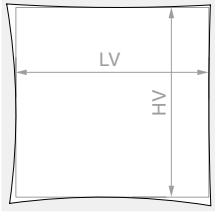

HV máx.: 3000 mm

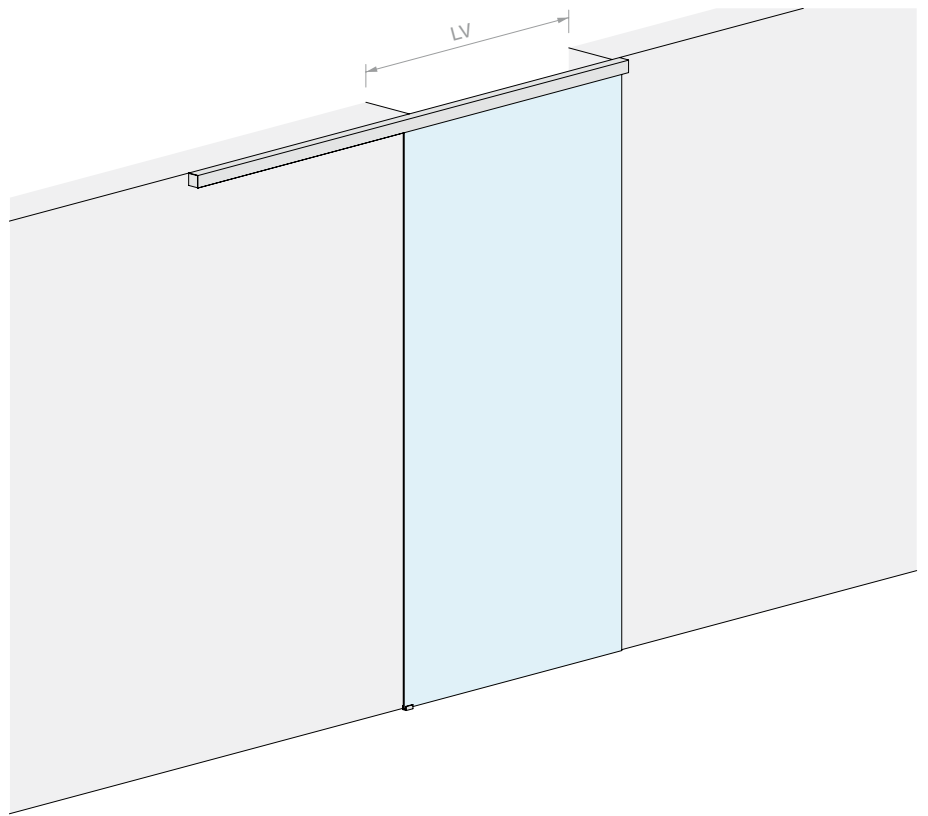

VIDRIO HOJA

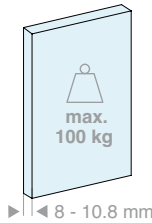

VIDRIO HOJA

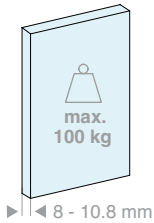

Kit formado por:

Art.	Descripción	Cant.
LM5864S.200	Riel fijación de techo	1 Ud.
LM0064CP.200	Cubierta para riel	1 Ud.
LMC13.200	Perfil de acabado	1 Ud.
LM63061TP33	Tapa de acabado	2 Uds.
CERPOS162	Pinza	2 Uds.
LMPS-STP55	Stop sin tope	2 Uds.
LMGF	Guía inferior	1 Ud.

Opcional

LMDMP070ZKIT	Kit amortiguador de doble acción 40-70 kg	1 Ud.
LMDMP100ZKIT	Kit amortiguador de doble acción 70-100 kg	1 Ud.

Kit formado por:

Art.	Descripción	Cant.
LM5864S.300	Riel fijación de techo	1 Ud.
LM0064CP.300	Cubierta para riel	1 Ud.
LMC13.300	Perfil de acabado	1 Ud.
LM63061TP33	Tapa de acabado	2 Uds.
CERPOS162	Pinza	2 Uds.
LMPS-STP55	Stop sin tope	2 Uds.
LMGF	Guía inferior	1 Ud.

Opcional

LMDMP070ZKIT	Kit amortiguador de doble acción 40-70 kg	1 Ud.
LMDMP100ZKIT	Kit amortiguador de doble acción 70-100 kg	1 Ud.

Art.	LV máx.:	Cant.
LMP6511P.200	920 mm	1 Ud.

Art.	LV máx.:	Cant.
LMP6511P.300	1420 mm	1 Ud.

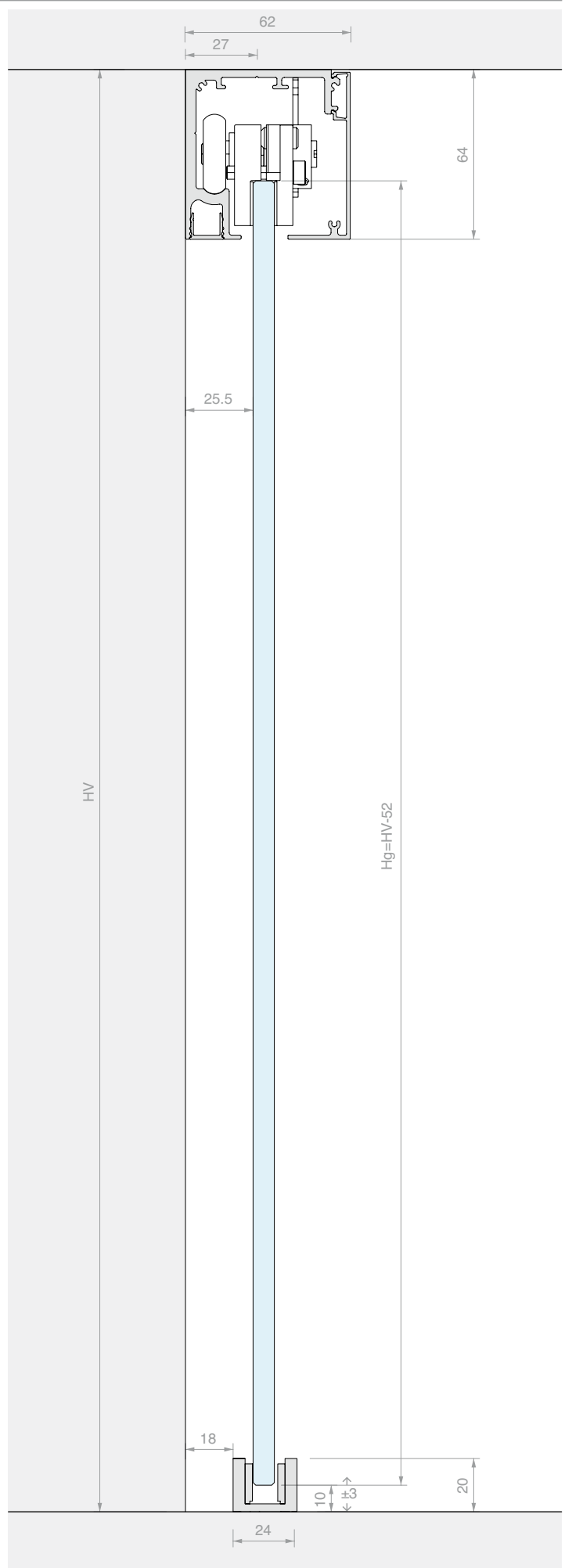
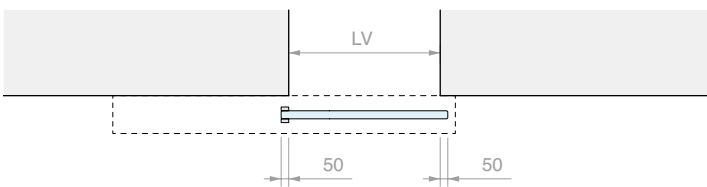
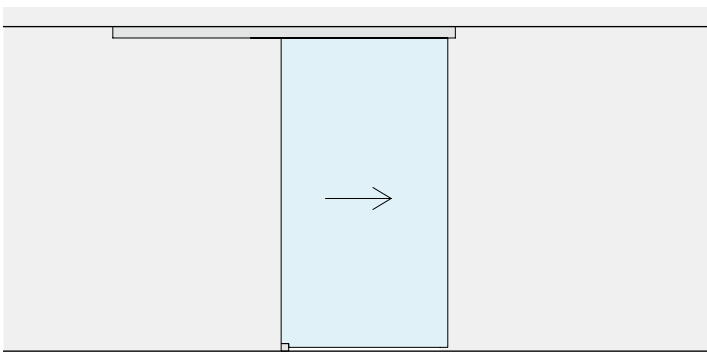
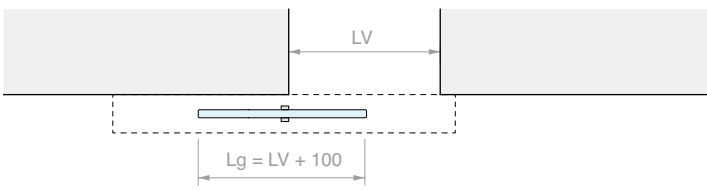
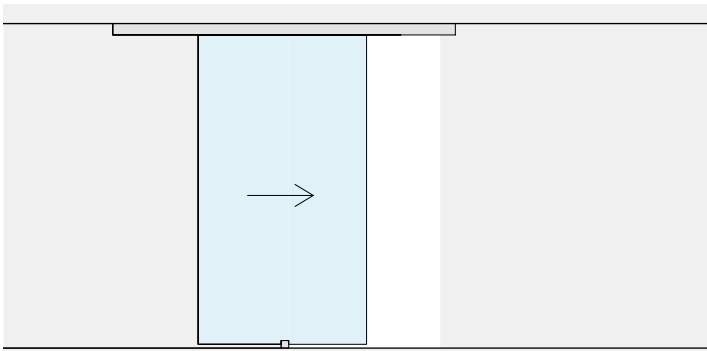
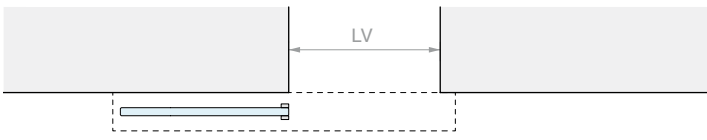
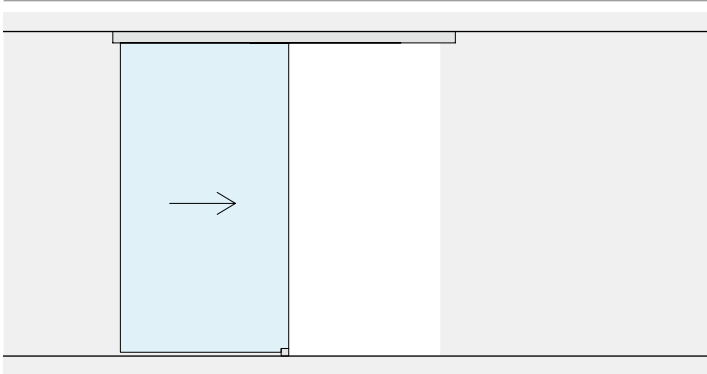







KIT CORREDERA FIJACIÓN DE TECHO DOBLE HOJA SINCRONIZADA

Material: Aluminio

Acabado: /6 /88 /97

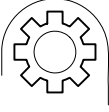
Novedades
2025

MEDIDAS DEL VANO

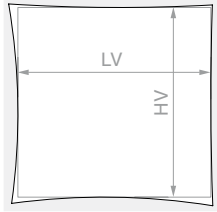

HV máx.: 3000 mm

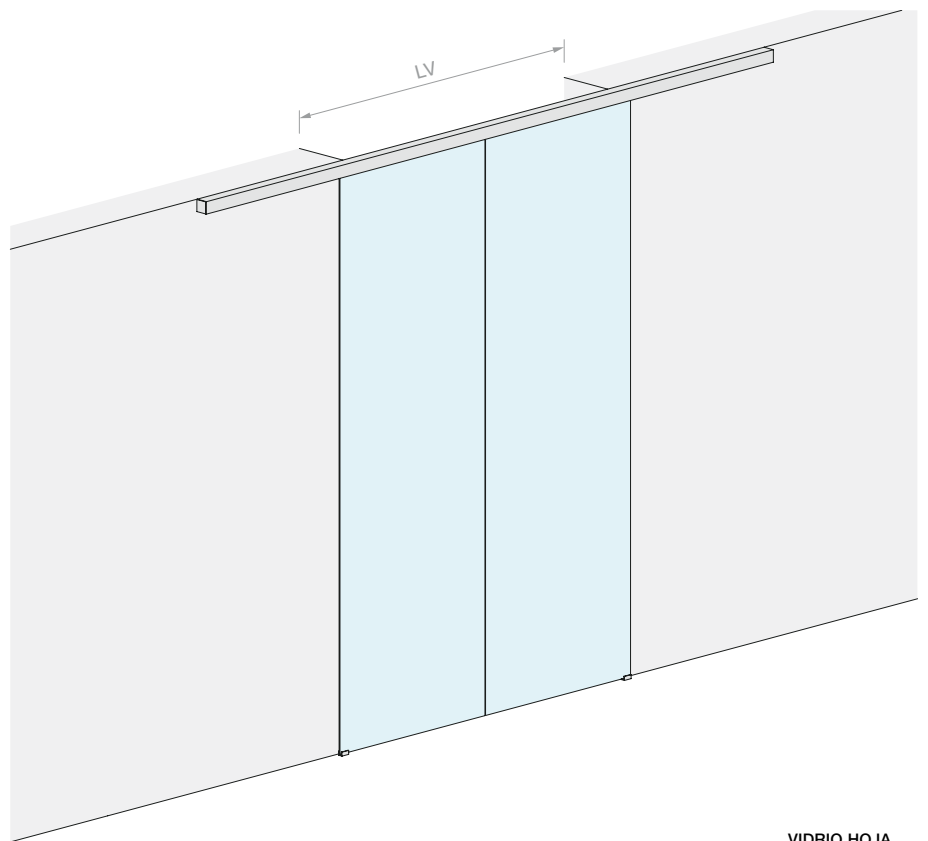

VIDRIO HOJA



8 - 10.8 mm

Kit formado por:

Art.	Descripción	Cant.
LM5864S.400	Riel fijación de techo	1 Ud.
LM0064CP.400	Cubierta para riel	1 Ud.
LMC13.200	Perfil de acabado	2 Uds.
LM63061TP33	Tapa de acabado	2 Uds.
CERPOS162	Pinza	4 Uds.
LMPS-STP55	Stop sin tope	4 Uds.
LMGF	Guía inferior	2 Uds.
LMSIN-AC55	Kit de sincronismo	1 Ud.

Opcional	Art.	Descripción	Cant.
	LMDMP100ZKIT	Kit amortiguador de doble acción 35-50 kg	1 Ud.

Art.	LV máx.:	Cant.
LMP6511CP.400	1940 mm	1 Ud.

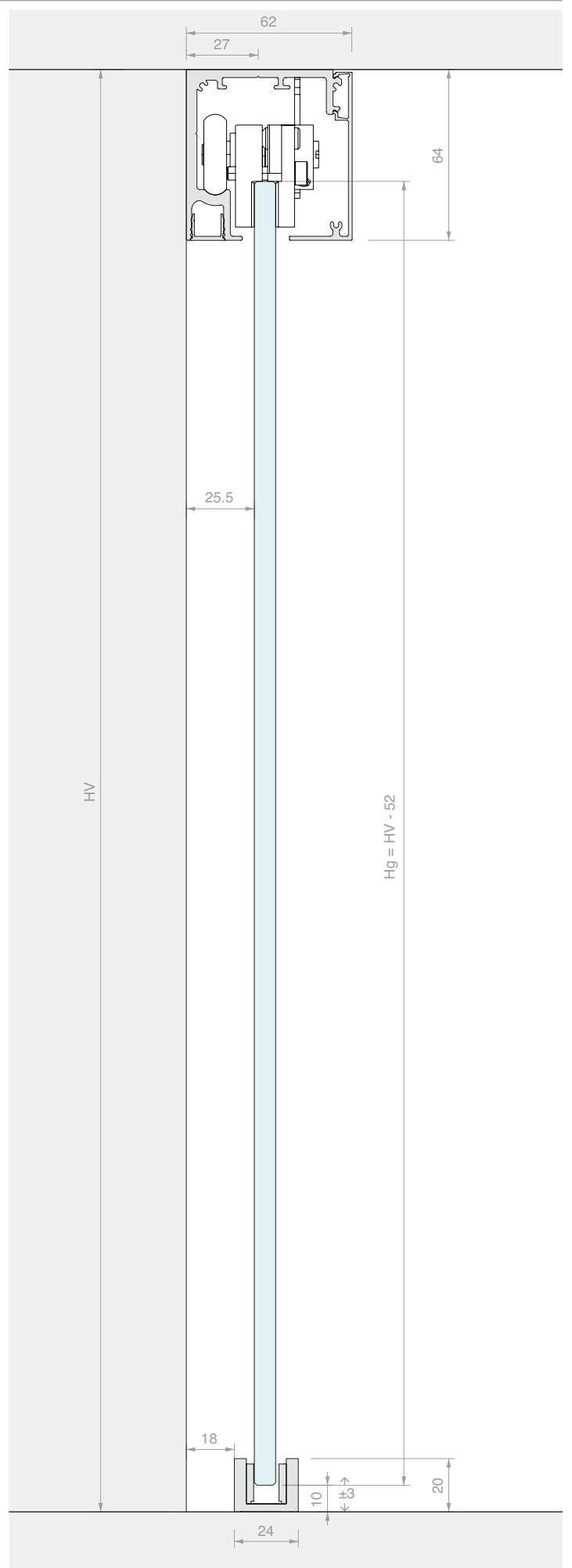
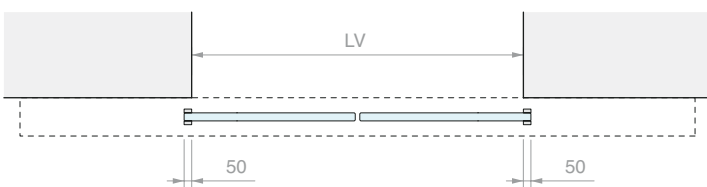
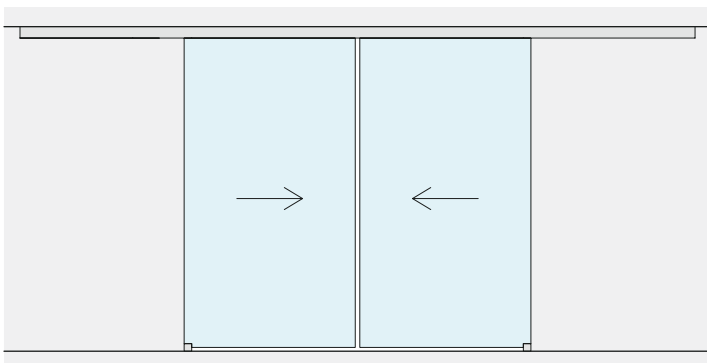
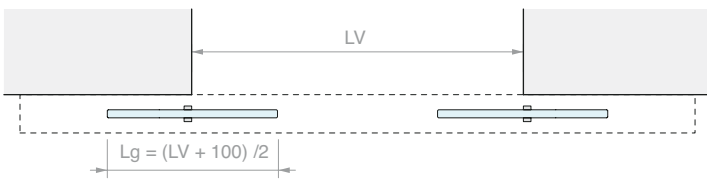
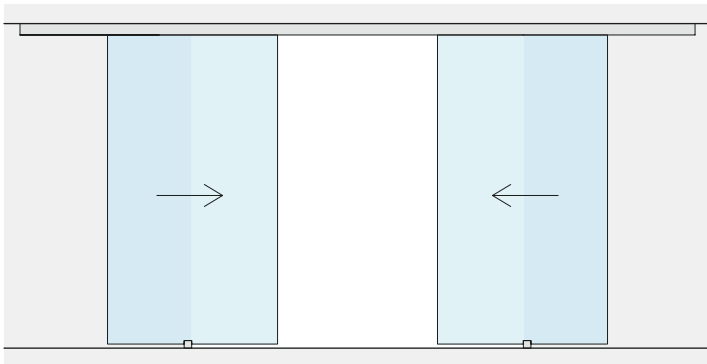
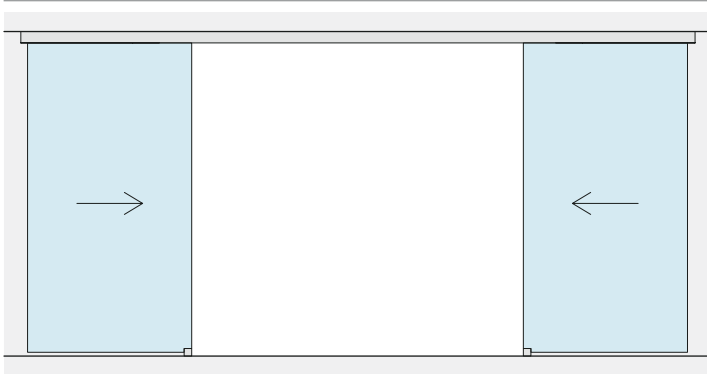







KIT CORREDERA FIJACIÓN DE TECHO HOJA INDIVIDUAL Y VIDRIO FIJO

Material: Aluminio

Acabado: /6 /88 /97

Novedades
2025

MEDIDAS DEL VANO

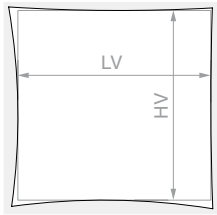

HV máx.: 3000 mm

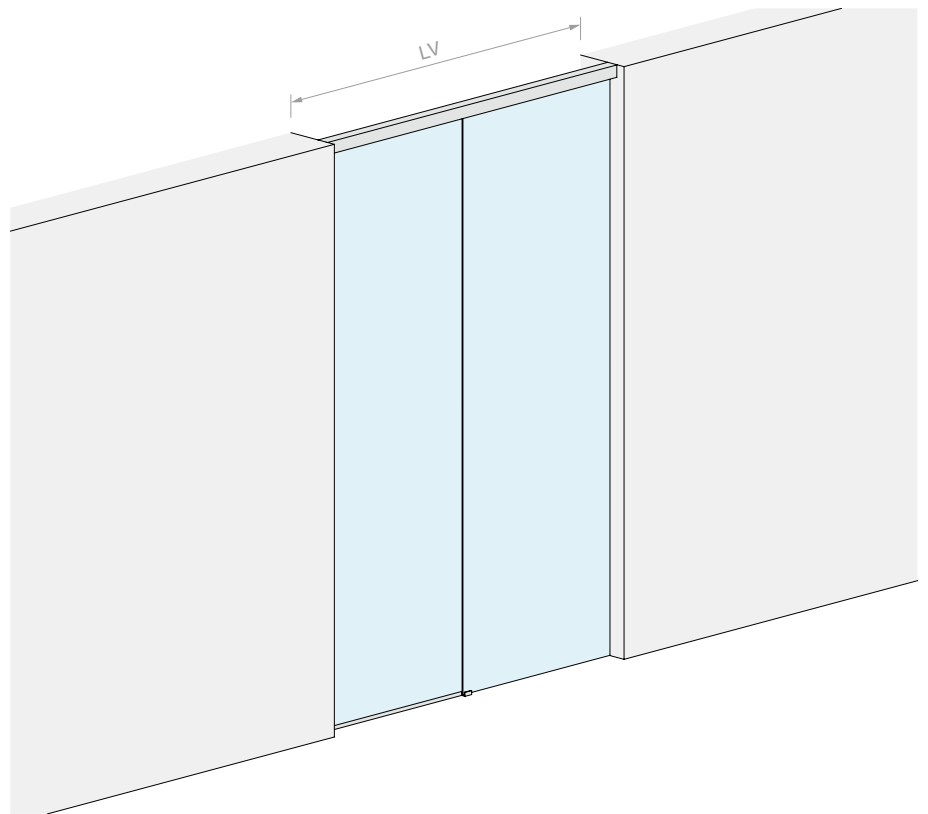

VIDRIO HOJA

VIDRIO FIJO

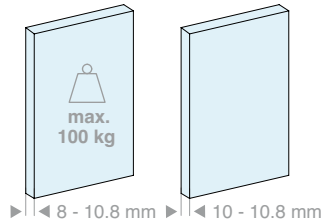

VIDRIO HOJA

VIDRIO FIJO

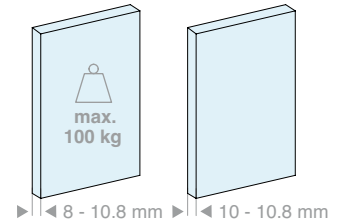

Kit formado por:

Art.	Descripción	Cant.
LM5864S.200	Riel fijación de techo	1 Ud.
LM0064CP.200	Cubierta para riel	1 Ud.
LMC13.100	Perfil de acabado	1 Ud.
LMU20.300	Perfil en «U»	1 Ud.
LMU20.150	Perfil en «U»	1 Ud.
LMU20TP	Tapa de acabado	1 Ud.
CERPOS162	Pinza	2 Uds.
LMPS-STP55	Stop sin tope	2 Uds.
GTUP2	Junta junquillo	5 m
LMGF	Guía inferior	1 Ud.

Opcional

LMDMP070ZKIT	Kit amortiguador de doble acción 40-70 kg	1 Ud.
LMDMP100ZKIT	Kit amortiguador de doble acción 70-100 kg	1 Ud.

Kit formado por:

Art.	Descripción	Cant.
LM5864S.300	Riel fijación de techo	1 Ud.
LM0064CP.300	Cubierta para riel	1 Ud.
LMC13.200	Perfil de acabado	1 Ud.
LMU20.300	Perfil en «U»	2 Uds.
LMU20TP	Tapa de acabado	1 Ud.
CERPOS162	Pinza	2 Uds.
LMPS-STP55	Stop sin tope	2 Uds.
GTUP2	Junta junquillo	5 m
LMGF	Guía inferior	1 Ud.

Opcional

LMDMP070ZKIT	Kit amortiguador de doble acción 40-70 kg	1 Ud.
LMDMP100ZKIT	Kit amortiguador de doble acción 70-100 kg	1 Ud.

Art.	LV máx.:	Cant.
LMP6511FP.200	2000 mm	1 Ud.

Art.	LV máx.:	Cant.
LMP6511FP.300	3000 mm	1 Ud.

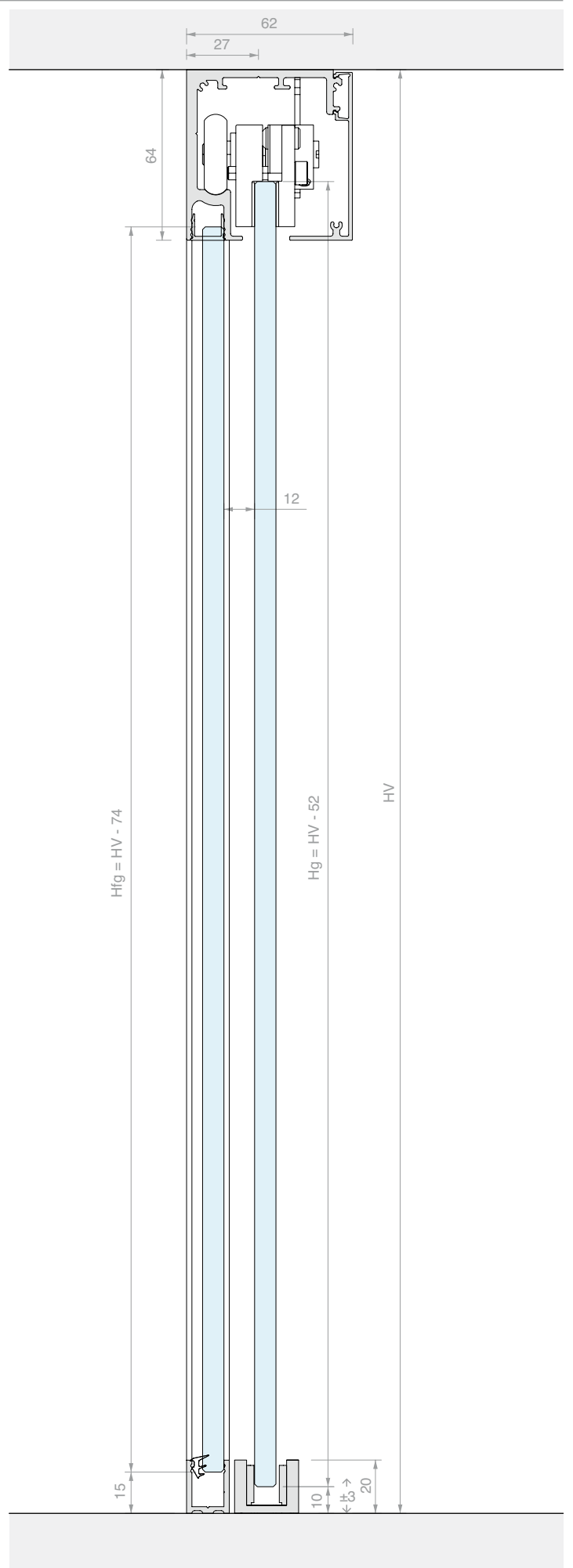
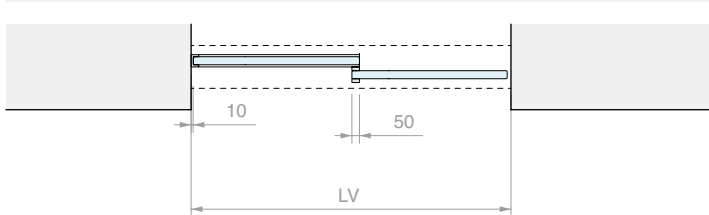
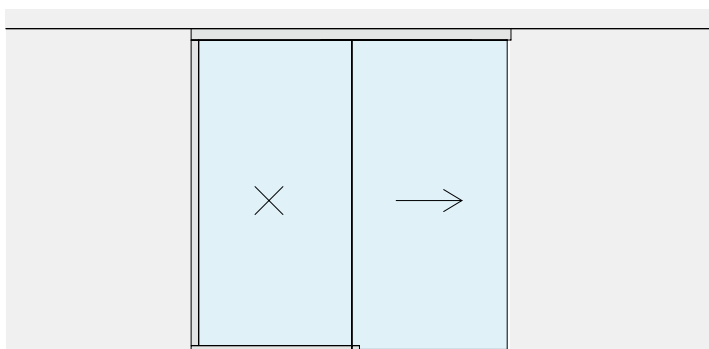
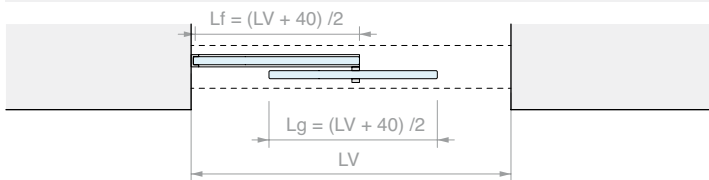
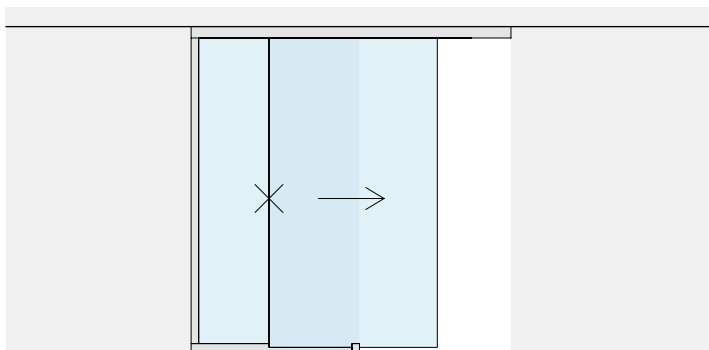
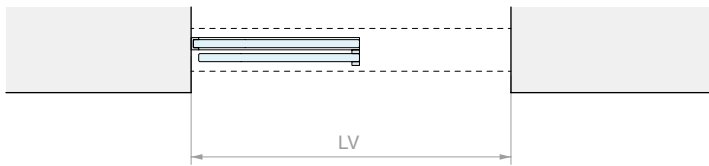
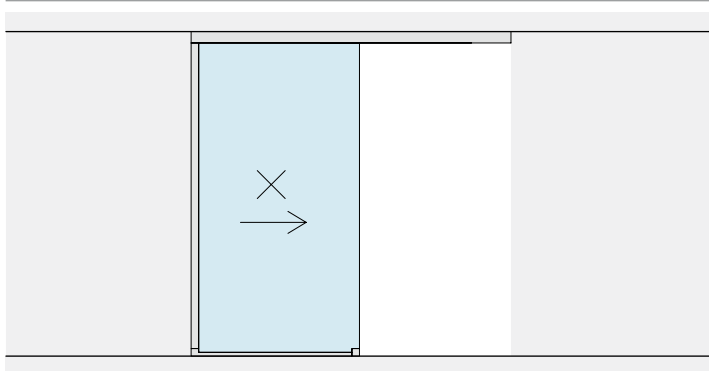







KIT CORREDERA FIJACIÓN DE TECHO HOJA DOBLE SINCRONIZADA Y DOBLE VIDRIO FIJO

Material: Aluminio

Acabado: /6 /88 /97

Novedades
2025

MEDIDAS DEL VANO

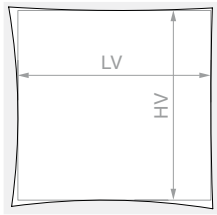

HV máx.: 3000 mm

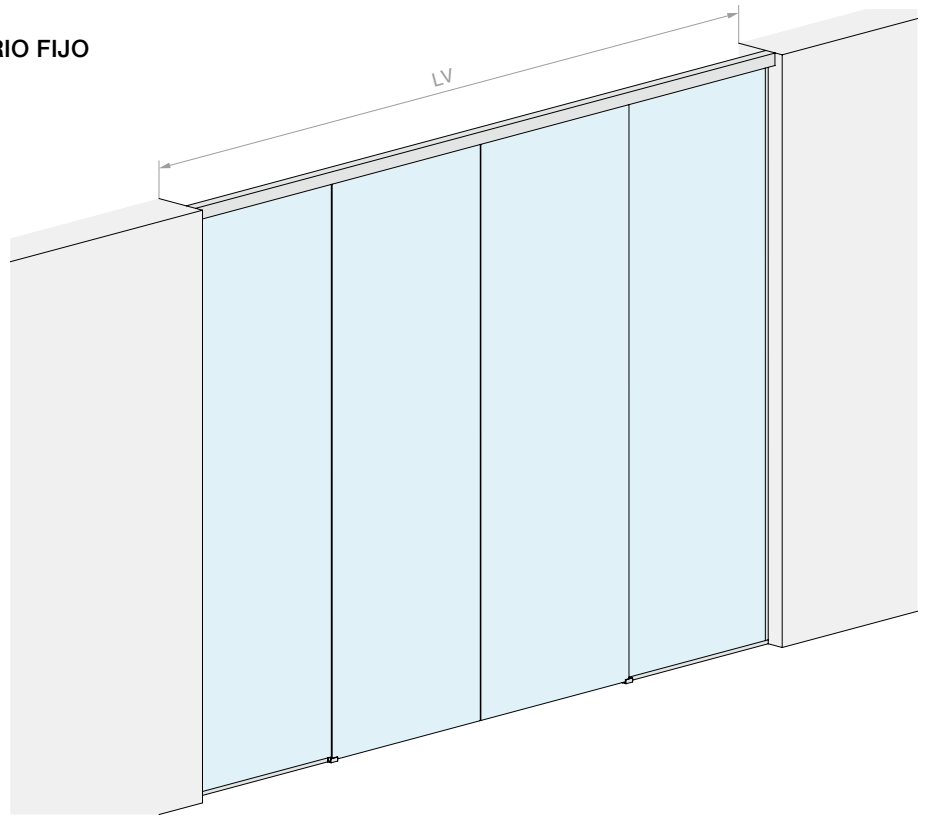

VIDRIO HOJA

VIDRIO FIJO

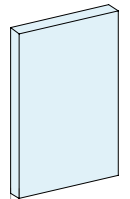

▶ | 8 - 10.8 mm | ▶ | 10 - 10.8 mm

Kit formado por:

Art.	Descripción	Cant.
LM5864S.400	Riel fijación de techo	1 Ud.
LM0064CP.400	Cubierta para riel	1 Ud.
LMC13.200	Perfil de acabado	1 Ud.
LMU20.300	Perfil en «U»	2 Uds.
LMU20.150	Perfil en «U»	2 Uds.
LMU20TP	Tapa de acabado	2 Uds.
CERPOS162	Pinza	4 Uds.
LMPS-STP55	Stop sin tope	4 Uds.
GTUP2	Junta junquillo	10 m
LMGF	Guía inferior	2 Uds.
LMSIN-AC55	Kit de sincronismo	1 Ud.

Opcional		
LMDMP100ZKIT	Kit amortiguador de doble acción 35-50 kg	1 Ud.

Art.	LV máx.:	Cant.
LMP6511CFP.400	4000 mm	1 Ud.

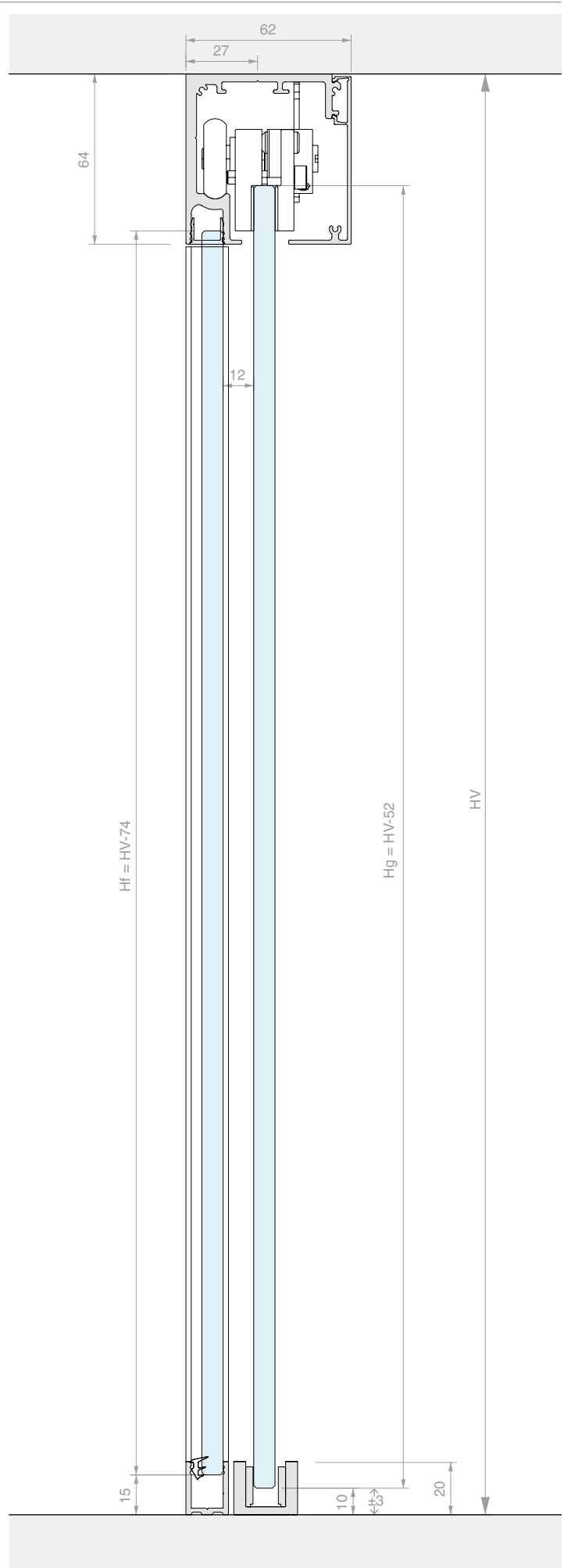
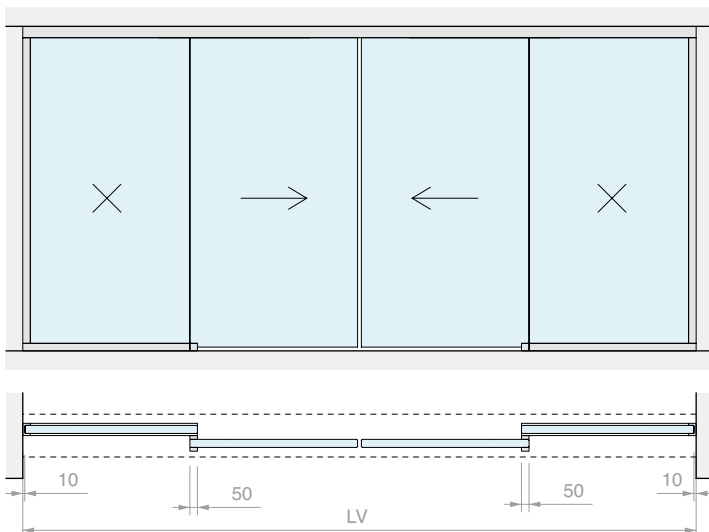
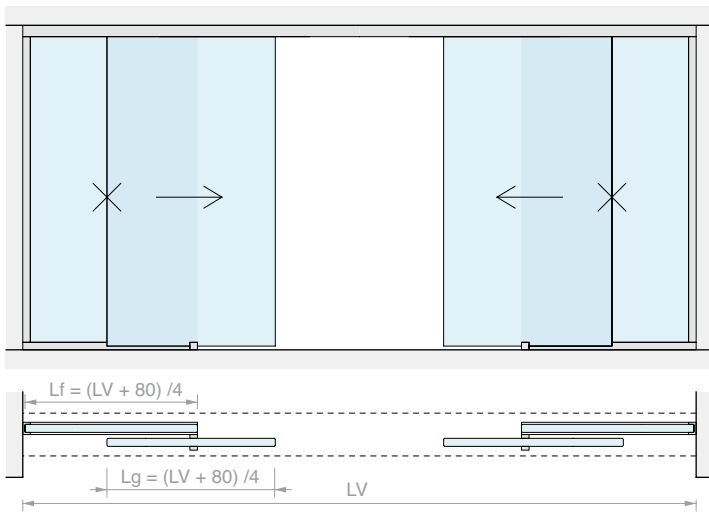
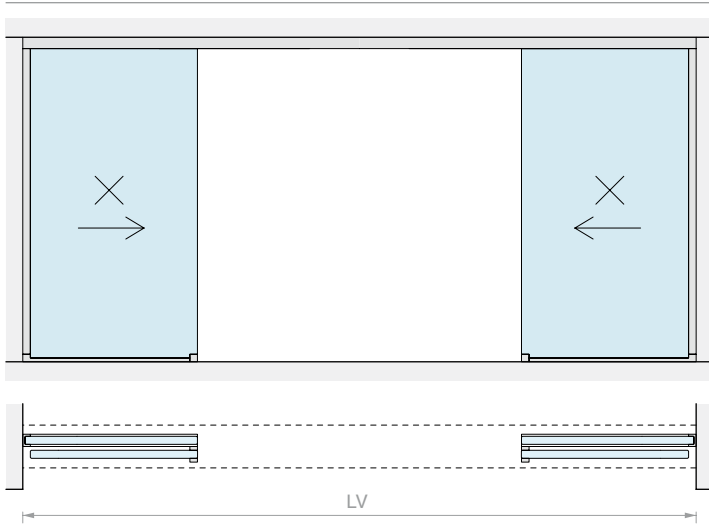







KIT CORREDERA FIJACIÓN A PARED HOJA INDIVIDUAL

Material: Aluminio

Acabado: /6 /88 /97

Novedades
2025

MEDIDAS DEL VANO

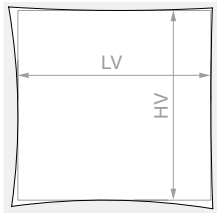

HV máx.: 3000 mm

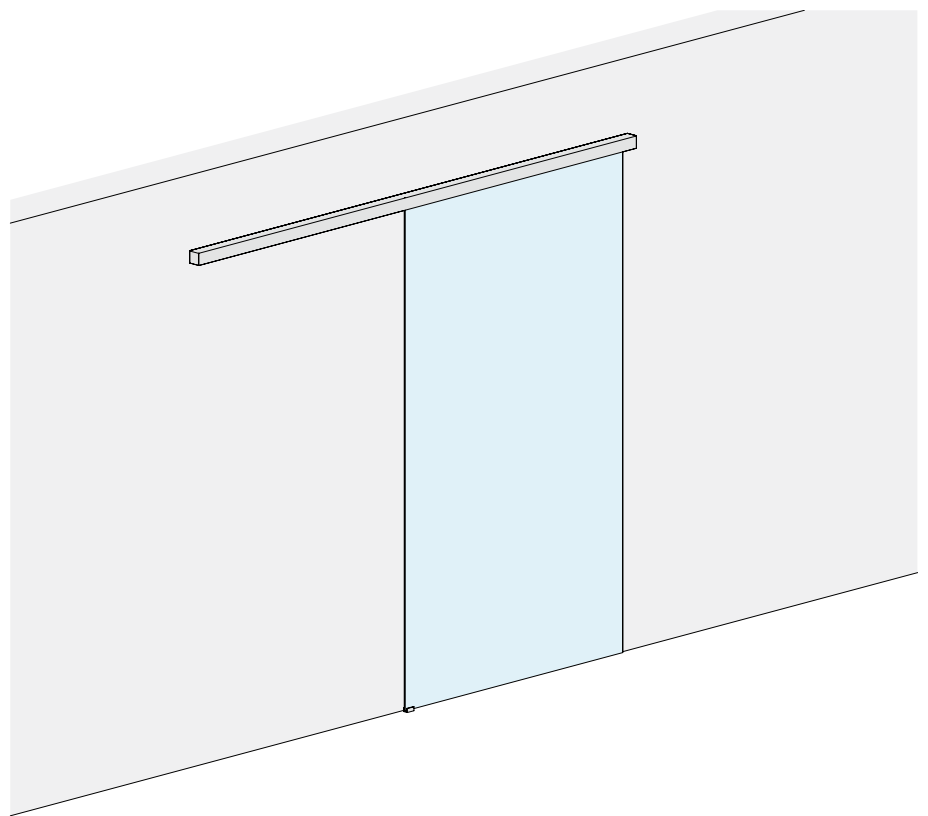

VIDRIO HOJA

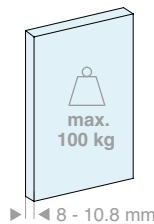

8 - 10.8 mm

VIDRIO HOJA

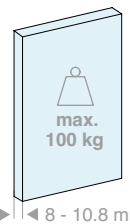

8 - 10.8 mm

Kit formado por:

Art.	Descripción	Cant.
LM5864P.200	Riel fijación a pared	1 Ud.
LM0064CP.200	Cubierta para riel	1 Ud.
LMC13.200	Perfil de acabado	1 Ud.
LM63061TP33	Tapa de acabado	2 Uds.
CERPOS162	Pinza	2 Uds.
LMPS-STP55	Stop sin tope	2 Uds.
LMGF	Guía inferior	1 Ud.

Opcional

LMDMP070ZKIT	Kit amortiguador de doble acción 40-70 kg	1 Ud.
LMDMP100ZKIT	Kit amortiguador de doble acción 70-100 kg	1 Ud.

Kit formado por:

Art.	Descripción	Cant.
LM5864P.300	Riel fijación a pared	1 Ud.
LM0064CP.300	Cubierta para riel	1 Ud.
LMC13.300	Perfil de acabado	1 Ud.
LM63061TP33	Tapa de acabado	2 Uds.
CERPOS162	Pinza	2 Uds.
LMPS-STP55	Stop sin tope	2 Uds.
LMGF	Guía inferior	1 Ud.

Opcional

LMDMP070ZKIT	Kit amortiguador de doble acción 40-70 kg	1 Ud.
LMDMP100ZKIT	Kit amortiguador de doble acción 70-100 kg	1 Ud.

Art.	LV máx.:	Cant.
LMP6521P.200	920 mm	1 Ud.

Art.	LV máx.:	Cant.
LMP6521P.300	1420 mm	1 Ud.

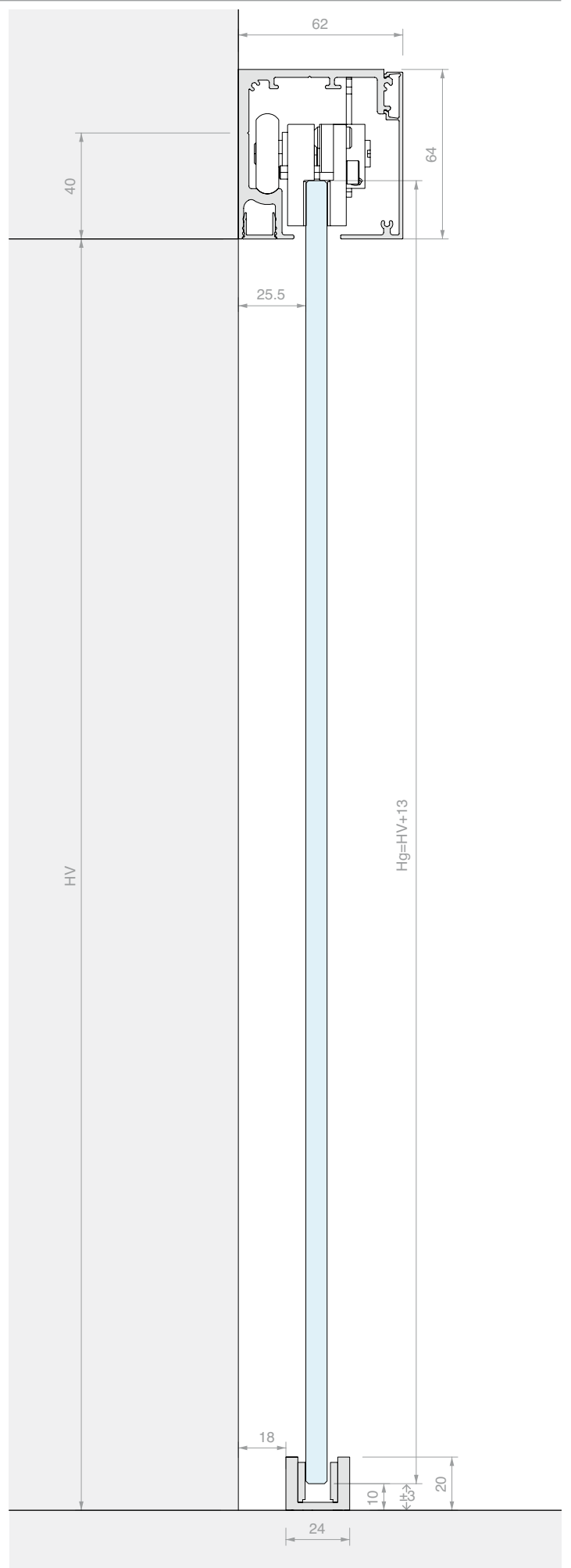
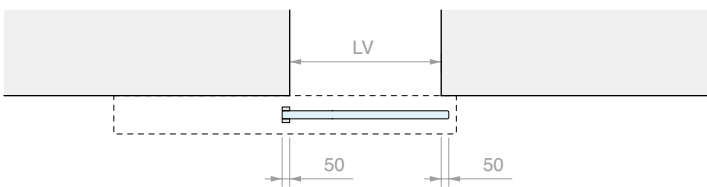
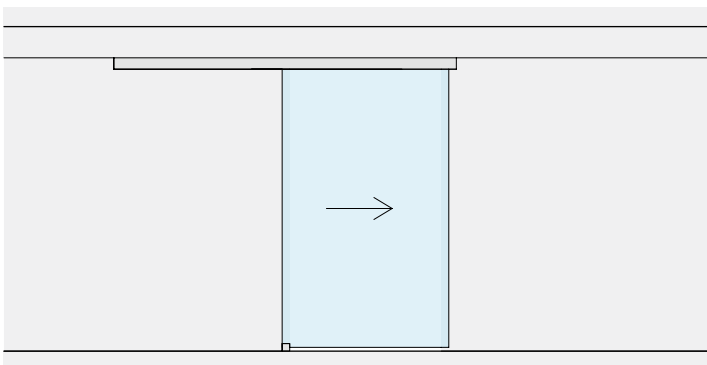
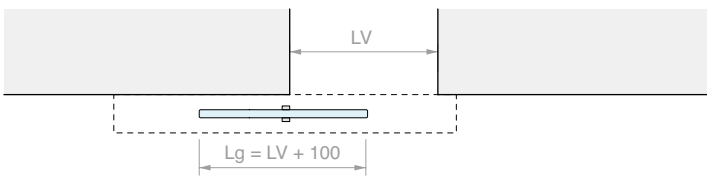
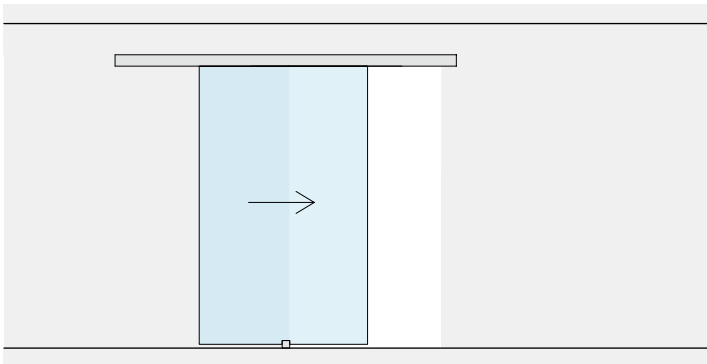
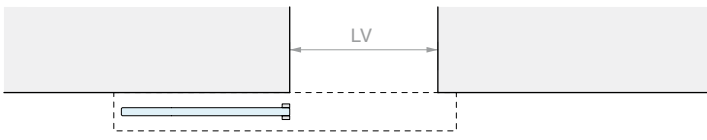
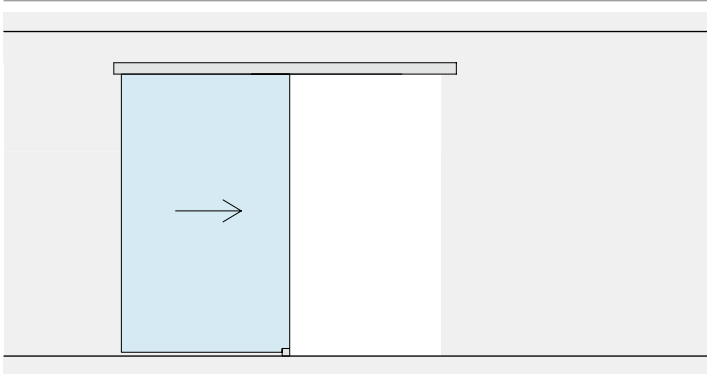



KIT CORREDERA FIJACIÓN A PARED DOBLE HOJA SINCRONIZADA

Material: Aluminio

Acabado: /6 /88 /97

Novedades
2025

MEDIDAS DEL VANO

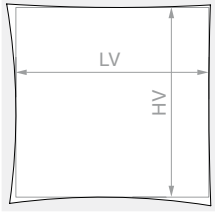

HV máx.: 3000 mm

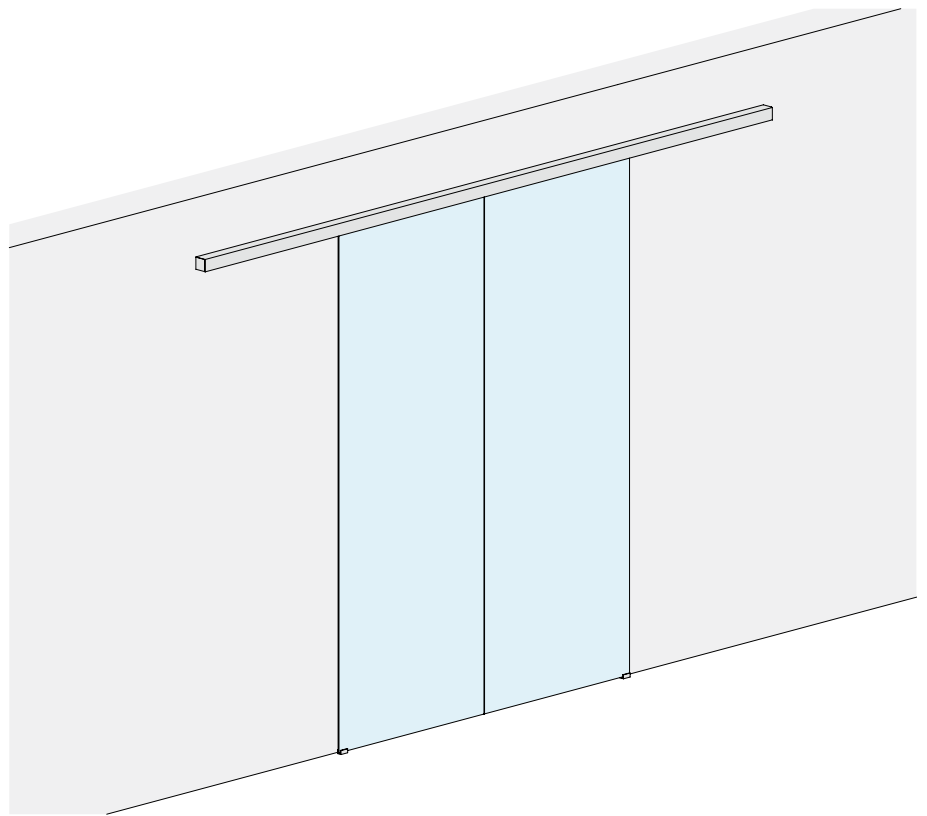

VIDRIO HOJA



8 - 10.8 mm

Kit formado por:

Art.	Descripción	Cant.
LM5864P.400	Riel fijación a pared	1 Ud.
LM0064CP.400	Cubierta para riel	1 Ud.
LMC13.200	Perfil de acabado	2 Uds.
LM63061TP33	Tapa de acabado	2 Uds.
CERPOS162	Pinza	4 Uds.
LMPS-STP55	Stop sin tope	4 Uds.
LMGF	Guía inferior	2 Uds.
LMSIN-AC55	Kit de sincronismo	1 Ud.

Opcional		Cant.
LMDMP100ZKIT	Kit amortiguador de doble acción 35-50 kg	1 Ud.

Art.	LV máx.:	Cant.
LMP6521CP.400	1940 mm	1 Ud.

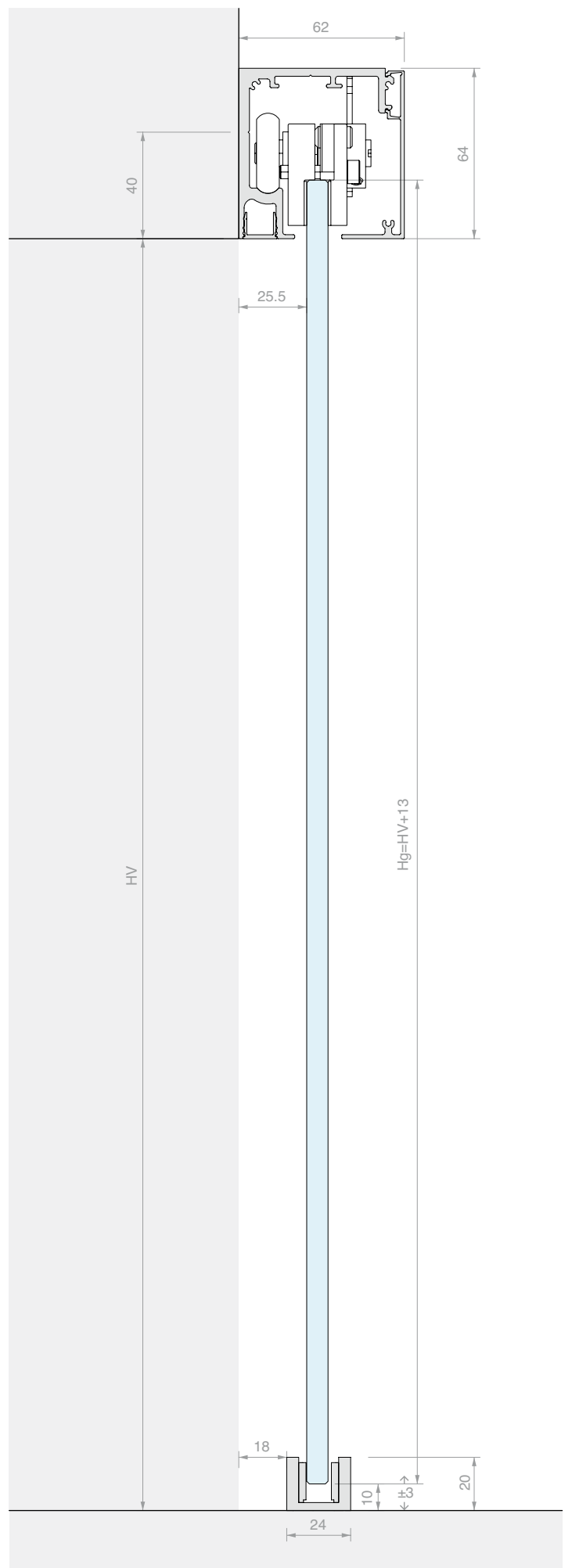
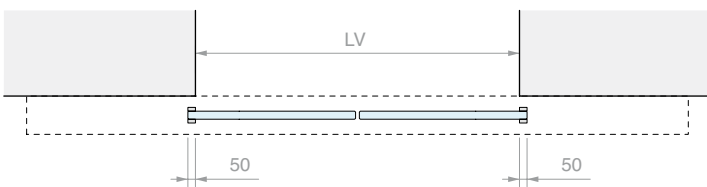
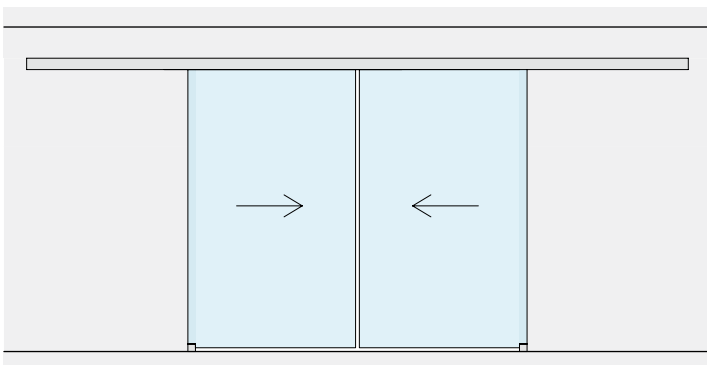
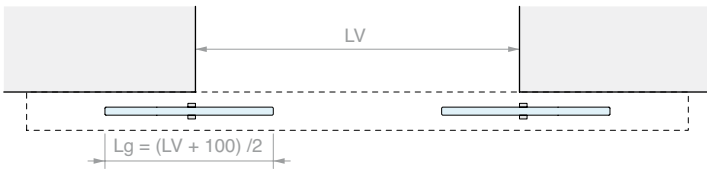
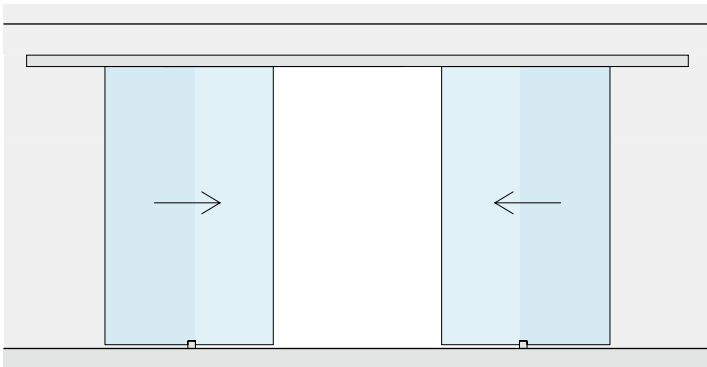
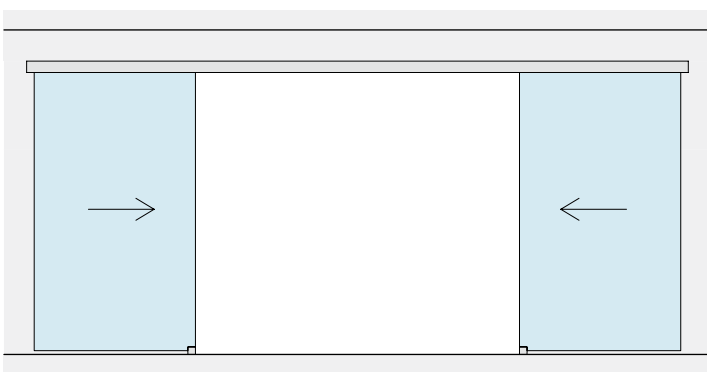







KIT CORREDERA FIJACIÓN A PARED HOJA INDIVIDUAL Y VIDRIO FIJO

Material: Aluminio

Acabado: /6 /88 /97

Novedades
2025

MEDIDAS DEL VANO

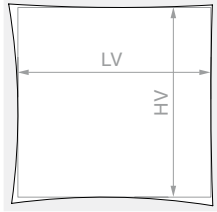

HV máx.: 3000 mm

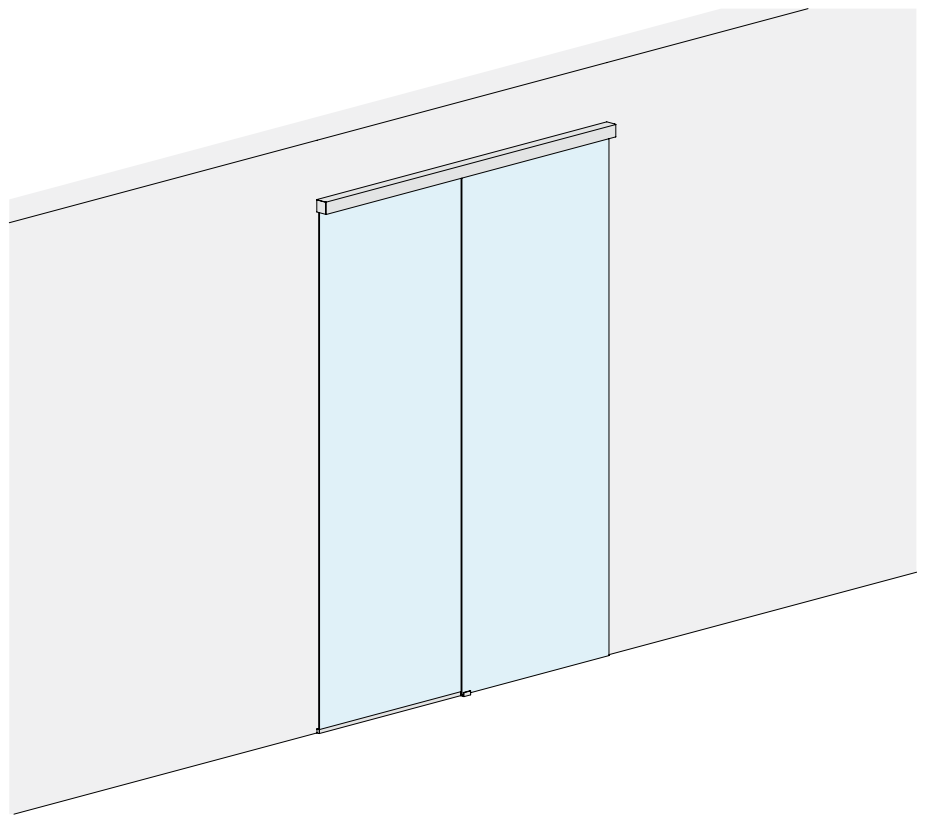

VIDRIO HOJA

VIDRIO FIJO

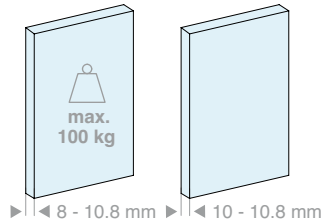

VIDRIO HOJA

VIDRIO FIJO

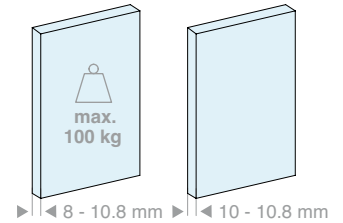

Kit formado por:

Art.	Descripción	Cant.
LM5864P.200	Riel fijación a pared	1 Ud.
LM0064CP.200	Cubierta para riel	1 Ud.
LMC13.200	Perfil de acabado	1 Ud.
LMU20.150	Perfil en «U»	1 Ud.
LM63061TP33	Tapa de acabado	2 Uds.
LMU20TP	Tapa de acabado	2 Uds.
CERPOS162	Pinza	2 Uds.
LMPS-STP55	Stop sin tope	2 Uds.
GTUP2	Junta junquillo	5 m
LMGF	Guía inferior	1 Ud.

Opcional

LMDMP070ZKIT	Kit amortiguador de doble acción 40-70 kg	1 Ud.
LMDMP100ZKIT	Kit amortiguador de doble acción 70-100 kg	1 Ud.

Kit formado por:

Art.	Descripción	Cant.
LM5864P.300	Riel fijación a pared	1 Ud.
LM0064CP.300	Cubierta para riel	1 Ud.
LMC13.200	Perfil de acabado	1 Ud.
LMU20.300	Perfil en «U»	1 Ud.
LM63061TP33	Tapa de acabado	2 Uds.
LMU20TP	Tapa de acabado	2 Uds.
CERPOS162	Pinza	2 Uds.
LMPS-STP55	Stop sin tope	2 Uds.
GTUP2	Junta junquillo	5 m
LMGF	Guía inferior	1 Ud.

Opcional

LMDMP070ZKIT	Kit amortiguador de doble acción 40-70 kg	1 Ud.
LMDMP100ZKIT	Kit amortiguador de doble acción 70-100 kg	1 Ud.

Art.	LV máx.:	Cant.
LMP6521FP.200	1880 mm	1 Ud.

Art.	LV máx.:	Cant.
LMP6521FP.300	2880 mm	1 Ud.

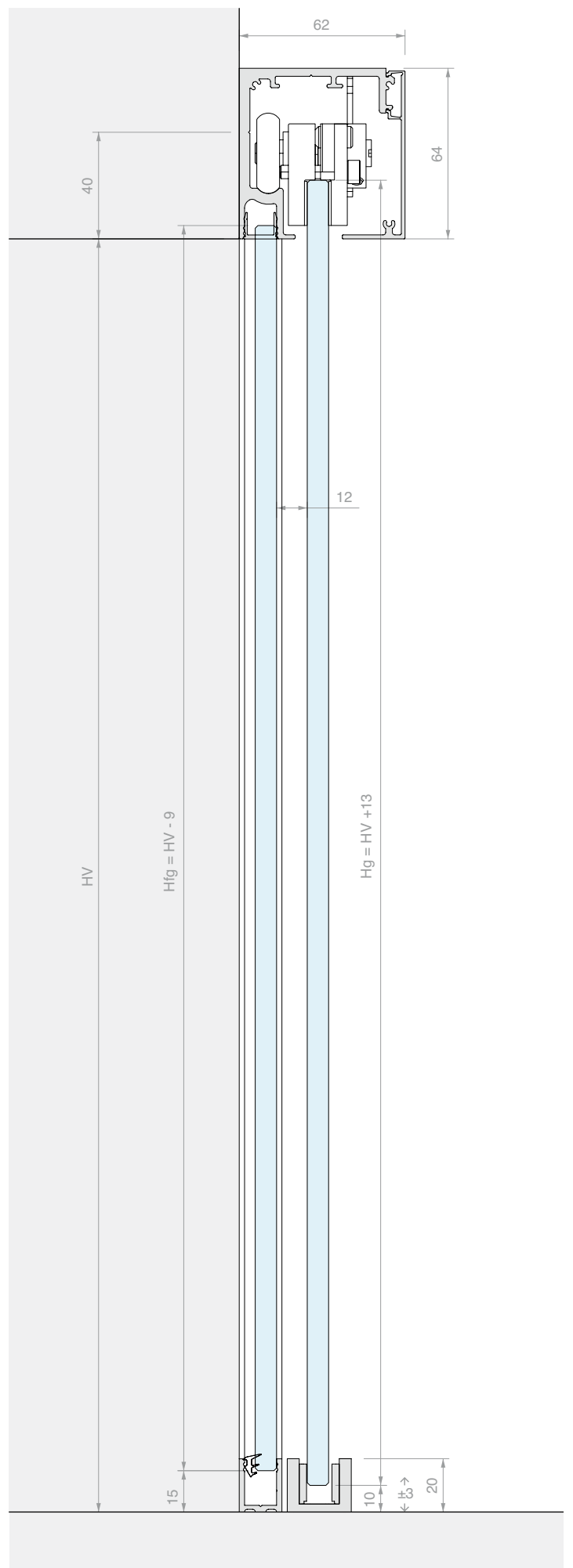
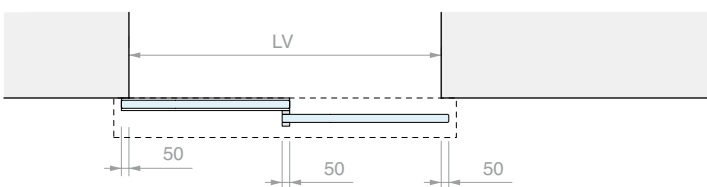
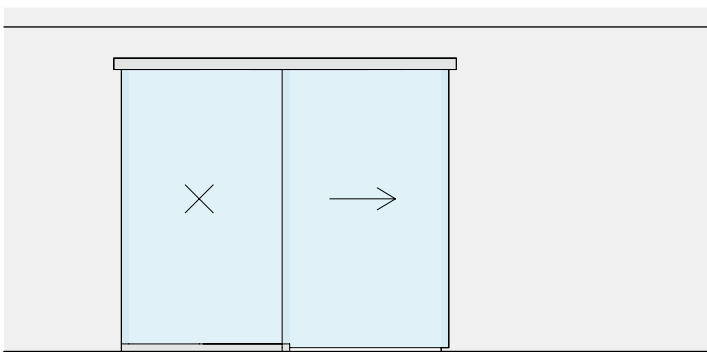
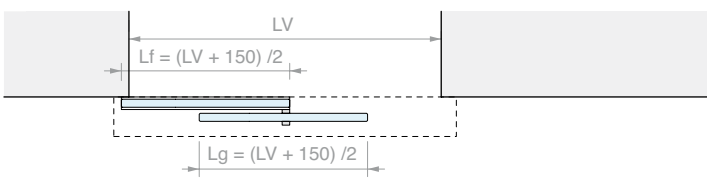
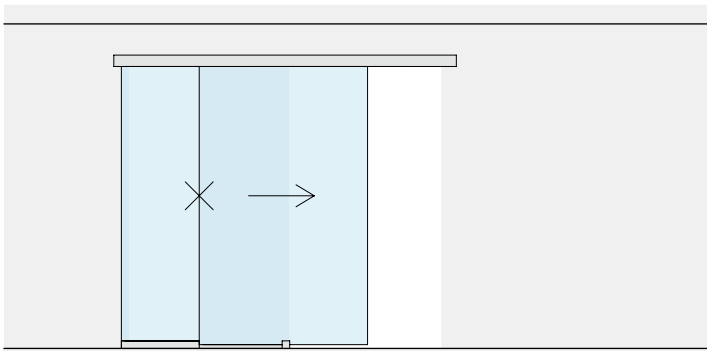
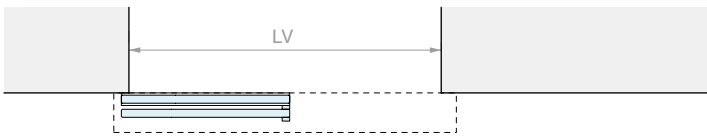
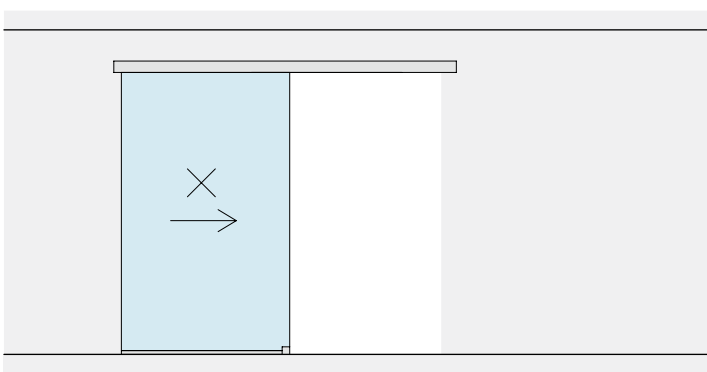



KIT CORREDERA FIJACIÓN A PARED HOJA DOBLE SINCRONIZADA Y DOBLE VIDRIO FIJO

Material: Aluminio

Acabado: /6 /88 /97

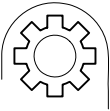
Novedades
2025

MEDIDAS DEL VANO

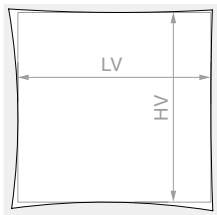

HV máx.: 3000 mm

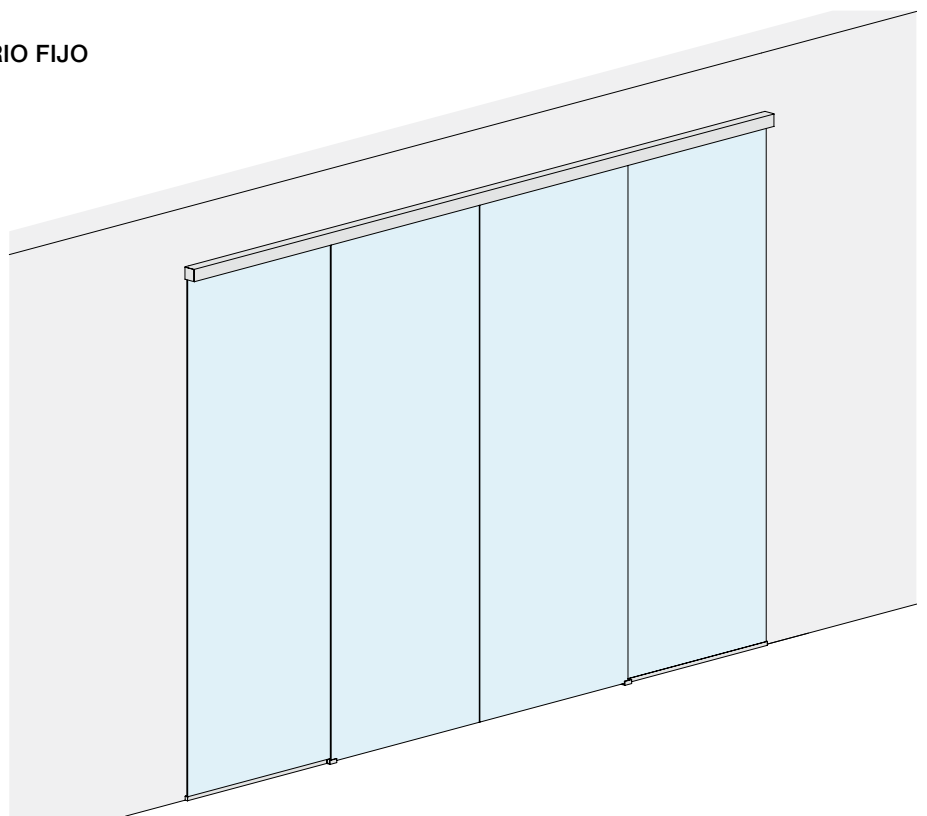

VIDRIO HOJA

VIDRIO FIJO

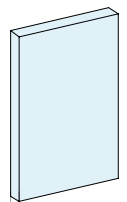

▶ |◀ 8 - 10.8 mm ▶ |◀ 10 - 10.8 mm ▶

Kit formado por:

Art.	Descripción	Cant.
LM5864P.400	Riel fijación a pared	1 Ud.
LM0064CP.400	Cubierta para riel	1 Ud.
LMC13.200	Perfil de acabado	1 Ud.
LMU20.300	Perfil en «U»	1 Ud.
LM63061TP33	Tapa de acabado	2 Uds.
LMU20TP	Tapa de acabado	4 Uds.
CERPOS162	Pinza	4 Uds.
LMPS-STP55	Stop sin tope	4 Uds.
GTUP2	Junta junquillo	10 m
LMGF	Guía inferior	2 Uds.
LMSIN-AC55	Kit de sincronismo	1 Ud.

Opcional

LMDMP100ZKIT	Kit amortiguador de doble acción 35-50 kg	1 Ud.
---------------------	---	-------

Art.	LV máx.:	Cant.
LMP6521CFP.400	3880 mm	1 Ud.

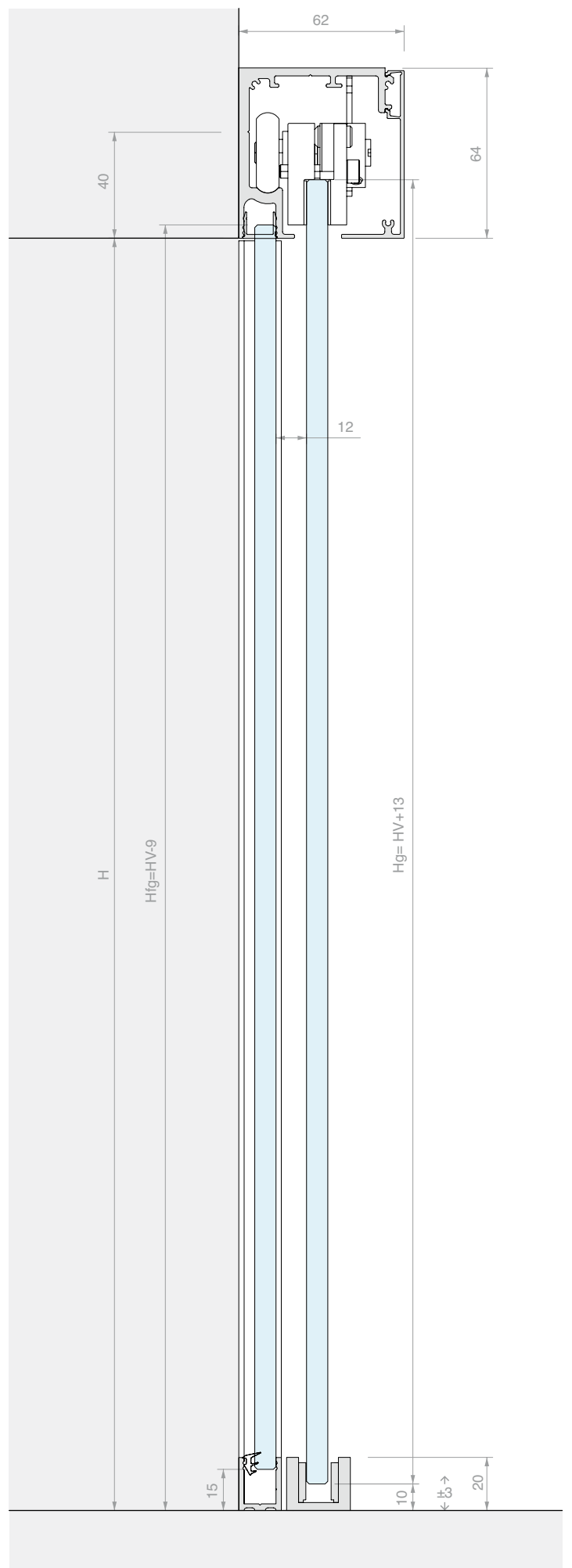
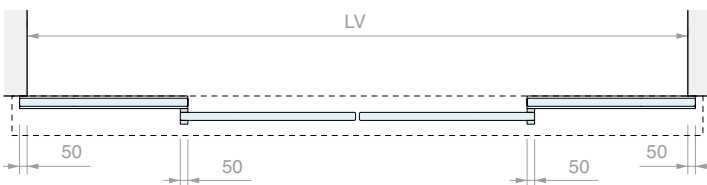
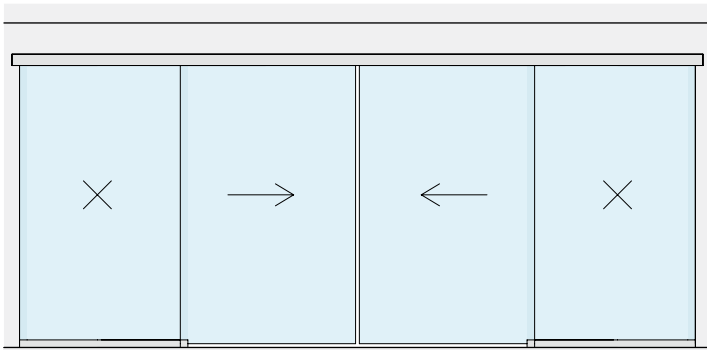
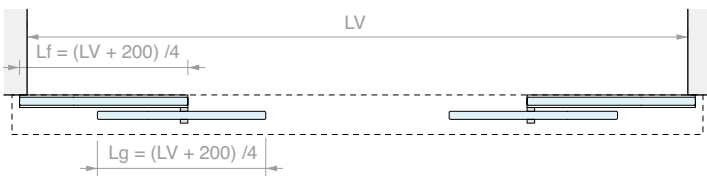
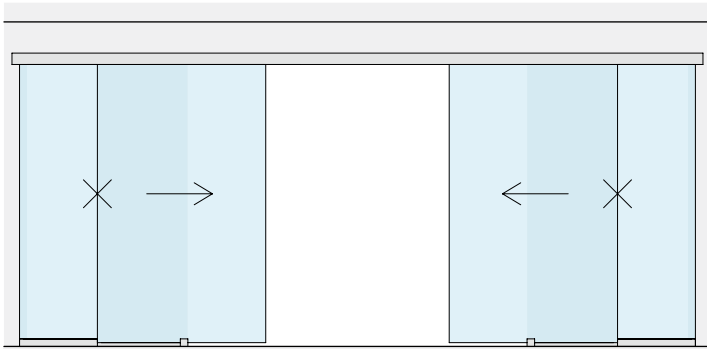
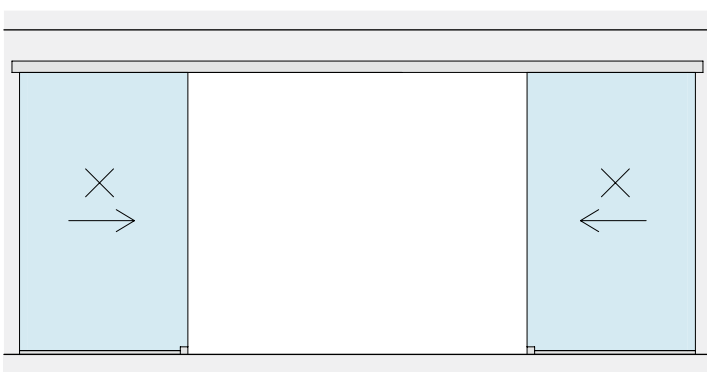



RIEL FIJACIÓN DE TECHO

Material: Aluminio

Acabado: /6 /88 /97

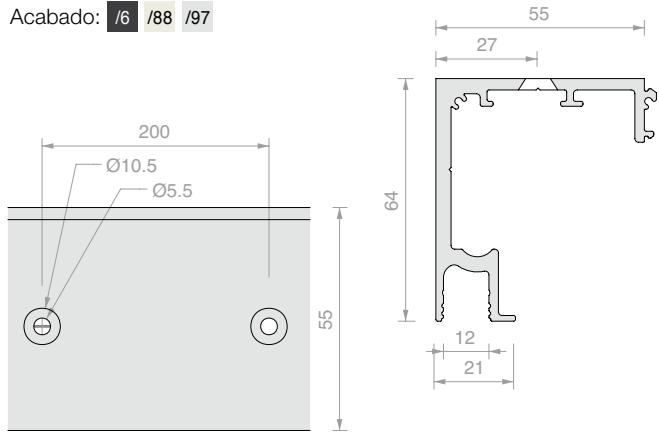

Art.	Longitud	Cant.
LM5864S.200	1998 mm	1 Ud.
LM5864S.300	2998 mm	1 Ud.
LM5864S.400	3998 mm	1 Ud.
LM5864S.600	6000 mm	1 Ud.



RIEL FIJACIÓN A PARED

Material: Aluminio

Acabado: /6 /88 /97

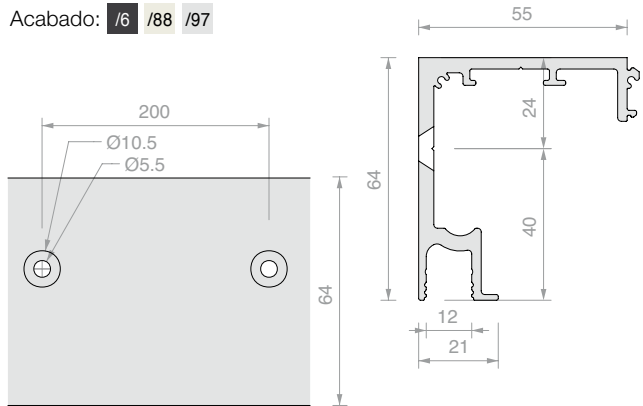

Art.	Longitud	Cant.
LM5864P.200	1998 mm	1 Ud.
LM5864P.300	2998 mm	1 Ud.
LM5864P.400	3998 mm	1 Ud.
LM5864P.600	6000 mm	1 Ud.



CUBIERTA PARA RIEL

Material: Aluminio

Acabado: /6 /88 /97

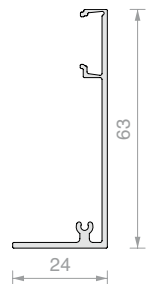

Art.	Longitud	Cant.
LM0064CP.200	1998 mm	1 Ud.
LM0064CP.300	2998 mm	1 Ud.
LM0064CP.400	3998 mm	1 Ud.
LM0064CP.600	6000 mm	1 Ud.

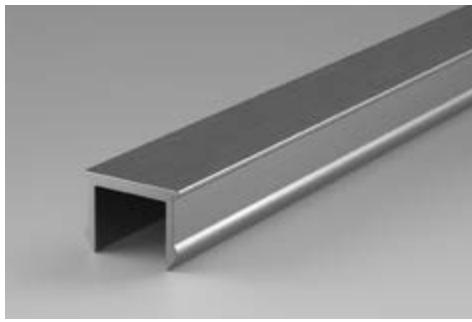

PERFIL DE ACABADO

Material: Aluminio
Acabado: /6 /88 /97

Art.	Longitud	Cant.
LMC13.100	996 mm	1 Ud.
LMC13.150	1498 mm	1 Ud.
LMC13.200	1998 mm	1 Ud.
LMC13.300	3000 mm	1 Ud.

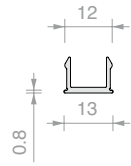

PERFIL EN «U»

Material: Aluminio
Acabado: /6 /88 /91 /97

Art.	Longitud	Cant.
LMU20.100	996 mm	1 Ud.
LMU20.150	1498 mm	1 Ud.
LMU20.300	3000 mm	1 Ud.

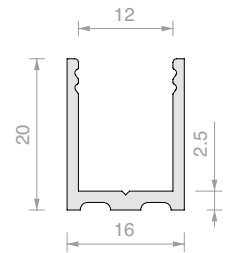

TAPA DE ACABADO

Material: Aluminio
Acabado: /88 /91 /97 /R2

Art.	Cant.
LMU20TP	1 Ud.

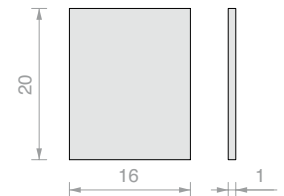

JUNTA JUNQUILLO

Material: PVC

Art.	Espesor	Color	Cant.	Art.	Espesor	Color	Cant.	Art.	Espesor	Color	Cant.
GTUP2	2 mm	Transparente	1 m	GTUP2G	2 mm	Gofrada	1 m	GTUP2N	2 mm	Negra	1 m
GTUP3	3 mm	Transparente	1 m	GTUP3G	3 mm	Gofrada	1 m	GTUP3N	3 mm	Negra	1 m
GTUP4	4 mm	Transparente	1 m	GTUP4G	4 mm	Gofrada	1 m	GTUP4N	4 mm	Negra	1 m
GTUP5	5 mm	Transparente	1 m	GTUP5G	5 mm	Gofrada	1 m	GTUP5N	5 mm	Negra	1 m
GTUP6	6 mm	Transparente	1 m	GTUP6G	6 mm	Gofrada	1 m	GTUP6N	6 mm	Negra	1 m



TAPA DE ACABADO 3 TORNILLOS

Material: Aluminio
Instalación tanto en lado izquierdo como derecho.
Acabado: /6 /88 /97

Art.	Cant.
LM63061TP33	1 Ud.

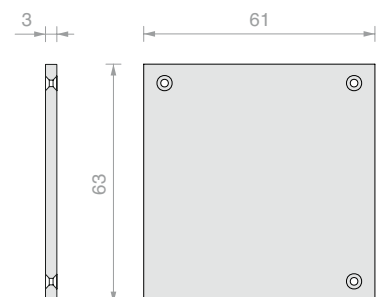



PINZA REGULABLE CON RUEDA

Material: Aluminio y acero

Art.	Para vidrios	Cant.
CERPOS162	De 8 a 10.8 mm	1 Ud.



STOP SIN TOPE

Material: Zamak

Art.	Cant.
LMPS-STP55	1 Ud.



GUÍA INFERIOR

Material: Aluminio

Acabado: /88 /97 /R2

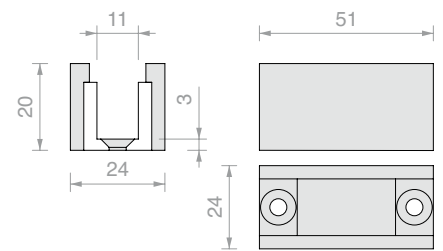

Art.	Para vidrios	Cant.
LMGF	De 8 a 10.8 mm	1 Ud.



KIT COMPLETO AMORTIGUADOR SOFTBREAK DE DOBLE ACCIÓN

Material: POM, Aluminio, Zamak

Permite amortiguar en apertura y en cierre

Art.	Capacidad de carga	Cant.
LMDMP070ZKIT	De 40 a 70 kg	1 Ud.
LMDMP100ZKIT	De 70 a 100 kg	1 Ud.



AMORTIGUADOR SOFTBREAK DE DOBLE ACCIÓN

Material: POM

Permite amortiguar en apertura y en cierre

El uso del amortiguador de choque también requiere una pinza de apoyo y 1/2 activadores en función del lado a amortiguar

Art.	Capacidad de carga	Cant.
LMDMP070Z	De 40 a 70 kg	1 Ud.
LMDMP100Z	De 70 a 100 kg	1 Ud.



ABRAZADERA DE SOPORTE PARA AMORTIGUADOR

Material: Aluminio

Art.	Cant.
LMPs-PSD62	1 Ud.



ACTIVADOR PARA AMORTIGUADOR

Material: Zamak

Art.	Cant.
LMSIN-GA55	1 Ud.



KIT DE SINCRONISMO

Art.	Cant.
LMSIN-AC55	1 Ud.

Forme

Perfiles de dimensiones reducidas para decorar las hojas de vidrio. Aplicación sobre vidrio mediante adhesivo de espesor de 0,5 mm, silicona o adhesivo UV. Seleccionar la guía y los accesorios adecuados para alojar el vidrio y su perfil de canteado.





PERFIL PLANO SERIE FORME

Material: Aluminio
 Acabado: /6 /88 /97 /RAL

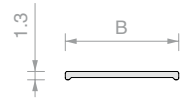

Art.	B	Longitud	Cant.
FOP10.30	10 mm	3000 mm	1 Ud.
FOP15.30	15 mm	3000 mm	1 Ud.
FOP20.30	20 mm	3000 mm	1 Ud.



PERFIL EN «U» SERIE FORME

Material: Aluminio
 Acabado: /6 /88 /97 /RAL

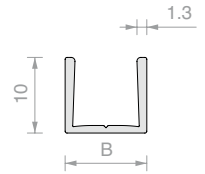

Art.	B	Longitud	Para vidrios	Cant.
FOU1011.30	10.8 mm	3000 mm	8 mm	1 Ud.
FOU1013.30	12.8 mm	3000 mm	10 mm	1 Ud.



ADHESIVO TESA® ACX^{plus}

Adhesivo transparente para la fijación de vidrio, acero y aluminio.
 El revestimiento de papel facilita la aplicación manual de la cinta.

Art.	Medidas	Espesor	Cant.
TS250065	6 mm x 25 m	0.5 mm	1 Ud.
TS250125	12 mm x 25 m	0.5 mm	1 Ud.
TS250155	15 mm x 25 m	0.5 mm	1 Ud.



GUÍA INFERIOR

Material: Aluminio
 Acabado: /88 /97 /R2

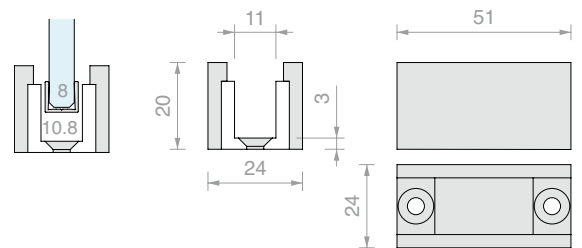

Art.	Para perfil	Cant.
LMGF	FOU1011	1 Ud.







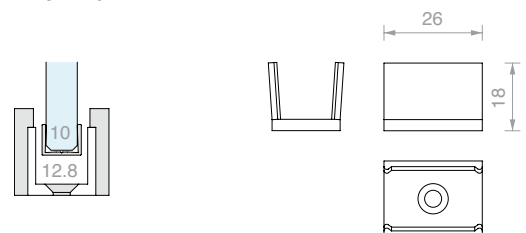

ADAPTADOR PARA GUÍA LMGF

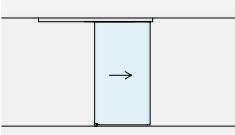
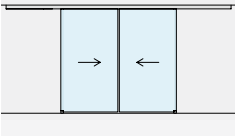
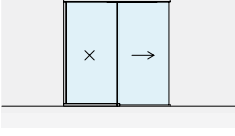
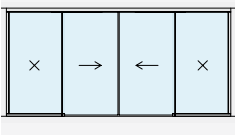
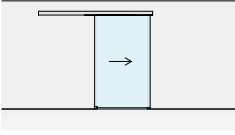

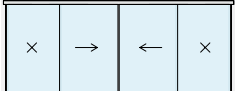



Accesorio que poner en la guía inferior LMGF Ma-
 terial: plástico
 Acabado: /56

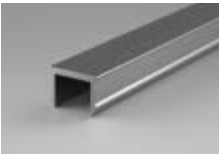



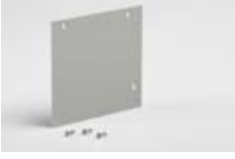







Art.	Para perfil	Cant.
LMGF13-POM	FOU1013	1 Ud.

Art.	Descripción	Acabado	Cant.	EURO
Kit corredera LM PORTA PRO				
	LMP6511P.200/6	Fijación a techo hoja simple Lvmax 920	Negro mate	1 Ud. 587,07
	LMP6511P.200/88	Fijación a techo hoja simple Lvmax 920	Alu. efecto inox satinado	1 Ud. 578,78
	LMP6511P.200/97	Fijación a techo hoja simple Lvmax 920	Aluminio mate	1 Ud. 560,14
	LMP6511P.300/6	Fijación a techo hoja simple Lvmax 1420	Negro mate	1 Ud. 663,21
	LMP6511P.300/88	Fijación a techo hoja simple Lvmax 1420	Alu. efecto inox satinado	1 Ud. 653,66
	LMP6511P.300/97	Fijación a techo hoja simple Lvmax 1420	Aluminio mate	1 Ud. 630,06
	LMP6511CP.400/6	Fijación a techo hoja doble sincronizada Lvmax 1940	Negro mate	1 Ud. 1.202,28
	LMP6511CP.400/88	Fijación a techo hoja doble sincronizada Lvmax 1940	Alu. efecto inox satinado	1 Ud. 1.182,85
	LMP6511CP.400/97	Fijación a techo hoja doble sincronizada Lvmax 1940	Aluminio mate	1 Ud. 1.156,91
	LMP6511FP.200/6	Fijación a techo hoja simple y vidrio fijo Lvmax 2000	Negro mate	1 Ud. 649,31
	LMP6511FP.200/88	Fijación a techo hoja simple y vidrio fijo Lvmax 2000	Alu. efecto inox satinado	1 Ud. 610,04
	LMP6511FP.200/97	Fijación a techo hoja simple y vidrio fijo Lvmax 2000	Aluminio mate	1 Ud. 599,39
	LMP6511FP.300/6	Fijación a techo hoja simple y vidrio fijo Lvmax 3000	Negro mate	1 Ud. 764,87
	LMP6511FP.300/88	Fijación a techo hoja simple y vidrio fijo Lvmax 3000	Alu. efecto inox satinado	1 Ud. 696,89
	LMP6511FP.300/97	Fijación a techo hoja simple y vidrio fijo Lvmax 3000	Aluminio mate	1 Ud. 679,16
	LMP6511CFP.400/6	Fijación a techo hoja doble sincronizada y vidrio doble fijo Lvmax 4000	Negro mate	1 Ud. 1.314,74
	LMP6511CFP.400/88	Fijación a techo hoja doble sincronizada y vidrio doble fijo Lvmax 4000	Alu. efecto inox satinado	1 Ud. 1.236,22
	LMP6511CFP.400/97	Fijación a techo hoja doble sincronizada y vidrio doble fijo Lvmax 4000	Aluminio mate	1 Ud. 1.214,91
	LMP6521P.200/6	Fijación a pared hoja simple Lvmax 920	Negro mate	1 Ud. 587,07
	LMP6521P.200/88	Fijación a pared hoja simple Lvmax 920	Alu. efecto inox satinado	1 Ud. 578,78
	LMP6521P.200/97	Fijación a pared hoja simple Lvmax 920	Aluminio mate	1 Ud. 560,14
	LMP6521P.300/6	Fijación a pared hoja simple Lvmax 1420	Negro mate	1 Ud. 663,21
	LMP6521P.300/88	Fijación a pared hoja simple Lvmax 1420	Alu. efecto inox satinado	1 Ud. 653,66
	LMP6521P.300/97	Fijación a pared hoja simple Lvmax 1420	Aluminio mate	1 Ud. 630,06
	LMP6521CP.400/6	Fijación a pared hoja doble sincronizada Lvmax 1940	Negro mate	1 Ud. 1.202,28
	LMP6521CP.400/88	Fijación a pared hoja doble sincronizada Lvmax 1940	Alu. efecto inox satinado	1 Ud. 1.182,85
	LMP6521CP.400/97	Fijación a pared hoja doble sincronizada Lvmax 1940	Aluminio mate	1 Ud. 1.156,91
	LMP6521FP.200/6	Fijación a pared hoja simple y vidrio fijo Lvmax 1880	Negro mate	1 Ud. 679,69
	LMP6521FP.200/88	Fijación a pared hoja simple y vidrio fijo Lvmax 1880	Alu. efecto inox satinado	1 Ud. 643,26
	LMP6521FP.200/97	Fijación a pared hoja simple y vidrio fijo Lvmax 1880	Aluminio mate	1 Ud. 621,28
	LMP6521FP.300/6	Fijación a pared hoja simple y vidrio fijo Lvmax 2880	Negro mate	1 Ud. 795,26
	LMP6521FP.300/88	Fijación a pared hoja simple y vidrio fijo Lvmax 2880	Alu. efecto inox satinado	1 Ud. 730,11
	LMP6521FP.300/97	Fijación a pared hoja simple y vidrio fijo Lvmax 2880	Aluminio mate	1 Ud. 701,07
	LMP6521CFP.400/6	Fijación a pared hoja doble sincronizada y vidrio doble fijo Lvmax 3880	Negro mate	1 Ud. 1.345,12
	LMP6521CFP.400/88	Fijación a pared hoja doble sincronizada y vidrio doble fijo Lvmax 3880	Alu. efecto inox satinado	1 Ud. 1.269,44
	LMP6521CFP.400/97	Fijación a pared hoja doble sincronizada y vidrio doble fijo Lvmax 3880	Aluminio mate	1 Ud. 1.236,80

	Art.	Descripción	Acabado	Cant.	EURO
	LM5864S.200/6	Riel fijación a techo, B55 H64 L1998	Negro mate	1 Ud.	167,60
	LM5864S.200/88	Riel fijación a techo, B55 H64 L1998	Alu. efecto inox satinado	1 Ud.	165,22
	LM5864S.200/97	Riel fijación a techo, B55 H64 L1998	Aluminio mate	1 Ud.	155,74
	LM5864S.300/6	Riel fijación a techo, B55 H64 L2998	Negro mate	1 Ud.	242,13
	LM5864S.300/88	Riel fijación a techo, B55 H64 L2998	Alu. efecto inox satinado	1 Ud.	238,57
	LM5864S.300/97	Riel fijación a techo, B55 H64 L2998	Aluminio mate	1 Ud.	224,36
	LM5864S.400/6	Riel fijación a techo, B55 H64 L3998	Negro mate	1 Ud.	316,67
	LM5864S.400/88	Riel fijación a techo, B55 H64 L3998	Alu. efecto inox satinado	1 Ud.	311,92
	LM5864S.400/97	Riel fijación a techo, B55 H64 L3998	Aluminio mate	1 Ud.	293,00
	LM5864S.600/6	Riel fijación a techo, B55 H64 L6000	Negro mate	1 Ud.	448,80
	LM5864S.600/88	Riel fijación a techo, B55 H64 L6000	Alu. efecto inox satinado	1 Ud.	441,67
	LM5864S.600/97	Riel fijación a techo, B55 H64 L6000	Aluminio mate	1 Ud.	413,27
	LM5864P.200/6	Riel fijación a pared, B55 H64 L1998	Negro mate	1 Ud.	167,60
	LM5864P.200/88	Riel fijación a pared, B55 H64 L1998	Alu. efecto inox satinado	1 Ud.	165,22
	LM5864P.200/97	Riel fijación a pared, B55 H64 L1998	Aluminio mate	1 Ud.	155,74
	LM5864P.300/6	Riel fijación a pared, B55 H64 L2998	Negro mate	1 Ud.	242,13
	LM5864P.300/88	Riel fijación a pared, B55 H64 L2998	Alu. efecto inox satinado	1 Ud.	238,57
	LM5864P.300/97	Riel fijación a pared, B55 H64 L2998	Aluminio mate	1 Ud.	224,36
	LM5864P.400/6	Riel fijación a pared, B55 H64 L3998	Negro mate	1 Ud.	316,67
	LM5864P.400/88	Riel fijación a pared, B55 H64 L3998	Alu. efecto inox satinado	1 Ud.	311,92
	LM5864P.400/97	Riel fijación a pared, B55 H64 L3998	Aluminio mate	1 Ud.	293,00
	LM5864P.600/6	Riel fijación a pared, B55 H64 L6000	Negro mate	1 Ud.	448,80
	LM5864P.600/88	Riel fijación a pared, B55 H64 L6000	Alu. efecto inox satinado	1 Ud.	441,67
	LM5864P.600/97	Riel fijación a pared, B55 H64 L6000	Aluminio mate	1 Ud.	413,27
	LM0064CP.200/6	Cubierta para riel, B25.7 H63 L1998	Negro mate	1 Ud.	52,14
	LM0064CP.200/88	Cubierta para riel, B25.7 H63 L1998	Alu. efecto inox satinado	1 Ud.	51,52
	LM0064CP.200/97	Cubierta para riel, B25.7 H63 L1998	Aluminio mate	1 Ud.	49,06
	LM0064CP.300/6	Cubierta para riel, B25.7 H63 L2998	Negro mate	1 Ud.	68,97
	LM0064CP.300/88	Cubierta para riel, B25.7 H63 L2998	Alu. efecto inox satinado	1 Ud.	68,02
	LM0064CP.300/97	Cubierta para riel, B25.7 H63 L2998	Aluminio mate	1 Ud.	64,33
	LM0064CP.400/6	Cubierta para riel, B25.7 H63 L3998	Negro mate	1 Ud.	85,78
	LM0064CP.400/88	Cubierta para riel, B25.7 H63 L3998	Alu. efecto inox satinado	1 Ud.	84,55
	LM0064CP.400/97	Cubierta para riel, B25.7 H63 L3998	Aluminio mate	1 Ud.	79,62
	LM0064CP.600/6	Cubierta para riel, B25.7 H63 L6000	Negro mate	1 Ud.	102,45
	LM0064CP.600/88	Cubierta para riel, B25.7 H63 L6000	Alu. efecto inox satinado	1 Ud.	100,61
	LM0064CP.600/97	Cubierta para riel, B25.7 H63 L6000	Aluminio mate	1 Ud.	93,21
	LMC13.100/6	Perfil de acabado, L996	Negro mate	1 Ud.	14,87
	LMC13.100/88	Perfil de acabado, L996	Alu. efecto inox satinado	1 Ud.	14,45
	LMC13.100/97	Perfil de acabado, L996	Aluminio mate	1 Ud.	14,06
	LMC13.150/6	Perfil de acabado, L1498	Negro mate	1 Ud.	18,30
	LMC13.150/88	Perfil de acabado, L1498	Alu. efecto inox satinado	1 Ud.	17,69
	LMC13.150/97	Perfil de acabado, L1498	Aluminio mate	1 Ud.	17,09
	LMC13.200/6	Perfil de acabado, L1998	Negro mate	1 Ud.	19,18
	LMC13.200/88	Perfil de acabado, L1998	Alu. efecto inox satinado	1 Ud.	18,44
	LMC13.200/97	Perfil de acabado, L1998	Aluminio mate	1 Ud.	17,75
	LMC13.300/6	Perfil de acabado, L3000	Negro mate	1 Ud.	20,28

	Art.	Descripción	Acabado	Cant.	EURO
	LMC13.300/88	Perfil de acabado, L3000	Alu. efecto inox satinado	1 Ud.	19,05
	LMC13.300/97	Perfil de acabado, L3000	Aluminio mate	1 Ud.	17,95
	LMU20.100/6	Perfil en "U", B16 H20 L996	Negro mate	1 Ud.	35,35
	LMU20.100/88	Perfil en "U", B16 H20 L996	Alu. efecto inox satinado	1 Ud.	31,02
	LMU20.100/91	Perfil en "U", B16 H20 L996	Aluminio lùcido	1 Ud.	32,85
	LMU20.100/97	Perfil en "U", B16 H20 L996	Aluminio mate	1 Ud.	29,48
	LMU20.150/6	Perfil en "U", B16 H20 L1498	Negro mate	1 Ud.	48,40
	LMU20.150/88	Perfil en "U", B16 H20 L1498	Alu. efecto inox satinado	1 Ud.	38,43
	LMU20.150/91	Perfil en "U", B16 H20 L1498	Aluminio lùcido	1 Ud.	40,19
	LMU20.150/97	Perfil en "U", B16 H20 L1498	Aluminio mate	1 Ud.	36,15
	LMU20.300/6	Perfil en "U", B16 H20 L3000	Negro mate	1 Ud.	71,28
	LMU20.300/88	Perfil en "U", B16 H20 L3000	Alu. efecto inox satinado	1 Ud.	56,06
	LMU20.300/91	Perfil en "U", B16 H20 L3000	Aluminio lùcido	1 Ud.	59,40
	LMU20.300/97	Perfil en "U", B16 H20 L3000	Aluminio mate	1 Ud.	51,59
	LMU20TP/88	Tapa plana, B16 H20 L1	Alu. efecto inox satinado	1 Ud.	6,36
	LMU20TP/91	Tapa plana, B16 H20 L1	Aluminio lùcido	1 Ud.	6,36
	LMU20TP/97	Tapa plana, B16 H20 L1	Aluminio mate	1 Ud.	6,25
	LMU20TP/R2	Tapa plana, B16 H20 L1	RAL9005 negro mate	1 Ud.	7,70
	GTUP2	Junta junquillo, H2	Transparente	1 m	1,21
	GTUP3	Junta junquillo, H3	Transparente	1 m	1,39
	GTUP4	Junta junquillo, H4	Transparente	1 m	1,69
	GTUP5	Junta junquillo, H5	Transparente	1 m	2,35
	GTUP6	Junta junquillo, H6	Transparente	1 m	3,30
	GTUP2G	Junta junquillo, H2	En relieve	1 m	1,80
	GTUP3G	Junta junquillo, H3	En relieve	1 m	2,02
	GTUP4G	Junta junquillo, H4	En relieve	1 m	2,29
	GTUP5G	Junta junquillo, H5	En relieve	1 m	2,60
	GTUP6G	Junta junquillo, H6	En relieve	1 m	3,81
	GTUP2N	Junta junquillo, H2	Negro	1 m	1,21
	GTUP3N	Junta junquillo, H3	Negro	1 m	1,39
	GTUP4N	Junta junquillo, H4	Negro	1 m	1,69
	GTUP5N	Junta junquillo, H5	Negro	1 m	2,35
	GTUP6N	Junta junquillo, H6	Negro	1 m	3,30
		LM63061TP33/6	Tapa de acabado con 3 tornillos, B61 H63	Negro mate	1 Ud.
LM63061TP33/88		Tapa de acabado con 3 tornillos, B61 H63	Alu. efecto inox satinado	1 Ud.	24,68
LM63061TP33/97		Tapa de acabado con 3 tornillos, B61 H63	Aluminio mate	1 Ud.	23,17
	CERPOS162	Pinza para correderas regulable con rueda, para vidrios 8/10.8		1 Ud.	146,74
	LMPS-STP55	Stop sin tope		1 Ud.	18,83
	LMGF/88	Guía en suelo, para vidrios 8/ 10.8, B25 H23 L46	Alu. efecto inox satinado	1 Ud.	26,31
	LMGF/97	Guía en suelo, para vidrios 8/ 10.8, B25 H23 L46	Aluminio mate	1 Ud.	26,31
	LMGF/R2	Guía en suelo, para vidrios 8/ 10.8, B25 H23 L46	RAL9005 negro mate	1 Ud.	31,59

	Art.	Descripción	Acabado	Cant.	EURO
	LMDMP070ZKIT	Kit completo amortiguador Softbreak de doble acción de 40 a 70 kg		1 Ud.	121,68
	LMDMP100ZKIT	Kit completo amortiguador Softbreak de doble acción de 70 a 100 kg		1 Ud.	121,68
	LMDMP070Z	Amortiguador Softbreak de doble acción de 40 a 70 kg		1 Ud.	67,54
	LMDMP100Z	Amortiguador Softbreak de doble acción de 70 a 100 kg		1 Ud.	67,54
	LMPS-PSD62	Abrazadera de soporte para amortiguador		1 Ud.	21,19
	LMSIN-GA55	Activador para amortiguador		1 Ud.	16,48
	LMSIN-AC55	Kit de sincronismo		1 Ud.	133,54
	FOP10.30/6	Perfil plano FORME, B10 H1.3 L3000	Negro mate	1 Ud.	33,32
	FOP10.30/88	Perfil plano FORME, B10 H1.3 L3000	Alu. efecto inox satinado	1 Ud.	33,32
	FOP10.30/97	Perfil plano FORME, B10 H1.3 L3000	Aluminio mate	1 Ud.	25,00
	FOP10.30/RAL	Perfil plano FORME, B10 H1.3 L3000	RAL9010 blanco lùcido	1 Ud.	29,16
	FOP15.30/6	Perfil plano FORME, B15 H1.3 L3000	Negro mate	1 Ud.	35,34
	FOP15.30/88	Perfil plano FORME, B15 H1.3 L3000	Alu. efecto inox satinado	1 Ud.	35,34
	FOP15.30/97	Perfil plano FORME, B15 H1.3 L3000	Aluminio mate	1 Ud.	27,02
	FOP15.30/RAL	Perfil plano FORME, B15 H1.3 L3000	RAL9010 blanco lùcido	1 Ud.	31,18
	FOP20.30/6	Perfil plano FORME, B20 H1.3 L3000	Negro mate	1 Ud.	37,98
	FOP20.30/88	Perfil plano FORME, B20 H1.3 L3000	Alu. efecto inox satinado	1 Ud.	37,98
	FOP20.30/97	Perfil plano FORME, B20 H1.3 L3000	Aluminio mate	1 Ud.	29,68
	FOP20.30/RAL	Perfil plano FORME, B20 H1.3 L3000	RAL9010 blanco lùcido	1 Ud.	33,82
	FOU1011.30/6	Perfil plano en "U" FORME, para vidrios 8, B10.8 H10 L3000	Negro mate	1 Ud.	47,24
	FOU1011.30/88	Perfil plano en "U" FORME, para vidrios 8, B10.8 H10 L3000	Alu. efecto inox satinado	1 Ud.	47,24
	FOU1011.30/97	Perfil plano en "U" FORME, para vidrios 8, B10.8 H10 L3000	Aluminio mate	1 Ud.	38,92
	FOU1011.30/RAL	Perfil plano en "U" FORME, para vidrios 8, B10.8 H10 L3000	RAL9010 blanco lùcido	1 Ud.	43,08
	FOU1013.30/6	Perfil plano en "U" FORME, para vidrios 10, B12.8 H10 L3000	Negro mate	1 Ud.	50,02
	FOU1013.30/88	Perfil plano en "U" FORME, para vidrios 10, B12.8 H10 L3000	Alu. efecto inox satinado	1 Ud.	50,02
	FOU1013.30/97	Perfil plano en "U" FORME, para vidrios 10, B12.8 H10 L3000	Aluminio mate	1 Ud.	41,70
FOU1013.30/RAL	Perfil plano en "U" FORME, para vidrios 10, B12.8 H10 L3000	RAL9010 blanco lùcido	1 Ud.	45,86	
	TS250065	Adhesivo de doble cara Tesa® ACXplus, B6 H0.5 L25m	Transparente	1 Ud.	33,26
	TS250125	Adhesivo de doble cara Tesa® ACXplus, B12 H0.5 L25m	Transparente	1 Ud.	66,52
	TS250155	Adhesivo de doble cara Tesa® ACXplus, B15 H0.5 L25m	Transparente	1 Ud.	105,50
	LMGF/88	Guía en suelo, para vidrios 8/ 10.8, B25 H23 L46	Alu. efecto inox satinado	1 Ud.	26,32
	LMGF/97	Guía en suelo, para vidrios 8/ 10.8, B25 H23 L46	Aluminio mate	1 Ud.	26,32
	LMGF/R2	Guía en suelo, para vidrios 8/ 10.8, B25 H23 L46	RAL9005 negro mate	1 Ud.	31,60
	LMGF13-POM/56	Adaptador para guía LMGF	Gris	1 Ud.	7,60



Saint-Gobain Logli S.r.l.
Via Chemnitz, 49/51
59100 Prato - Italia
www.sg-logli.it

