

 **logli**
SAINT-GOBAIN

NUOVO
LM PORTA PRO

Essenziale, evoluto,
sorprendente.



SAINT-GOBAIN

LM PORTA PRO

NOVITÀ
2025

Design

Essenziale, evoluto, sorprendente.

LM PORTA PRO è un sistema scorrevole che coniuga **design pulito, versatilità progettuale e prestazioni tecniche elevate.**

Linee squadrate, proporzioni armoniose e profili ottimizzati si integrano perfettamente in ogni ambiente, dando vita a una soluzione elegante e contemporanea.

Il cuore del sistema, un **binario compatto da 62 x 64 mm** e una **nuova pinza interamente in alluminio**, progettati per garantire affidabilità e durata. Il risultato? **Performance testate fino a 45.000 cicli di apertura e chiusura**, per un utilizzo intensivo e sempre fluido.

L'identità LM PORTA resta ben riconoscibile:

Fissaggio a parete o a soffitto

Configurazioni con o senza vetro fisso

Un unico ammortizzatore per anta che assicura un movimento fluido e silenzioso, sia in apertura che in chiusura

LM PORTA PRO

Il sistema completo, pensato per durare.

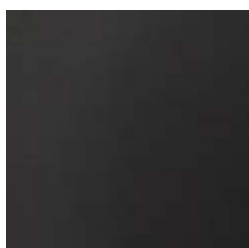
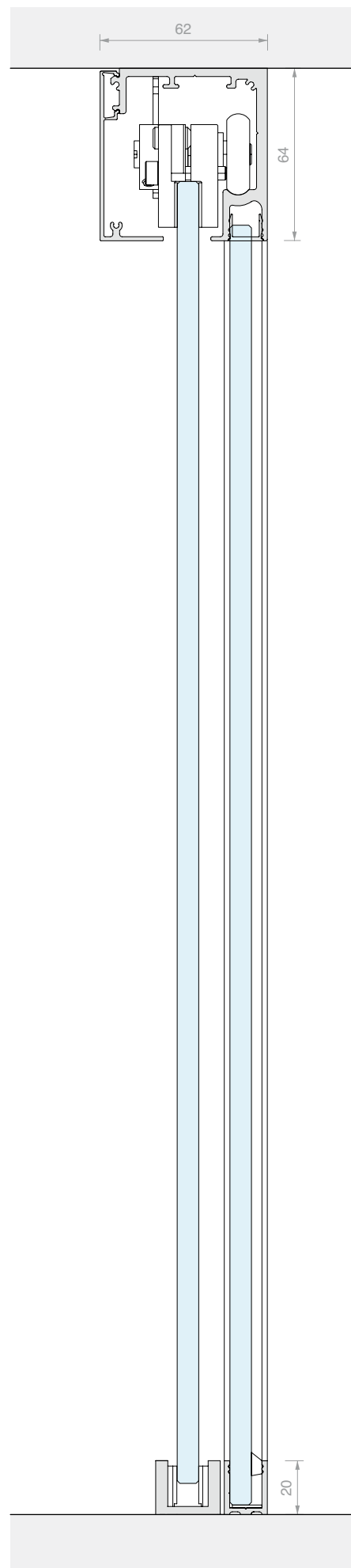

/6
Nero opaco



/88
Alluminio simil-inox satin



/97
Alluminio opaco

Testato secondo UNI EN 1527

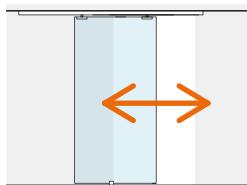

Porte di 100 kg
oltre **45.000** cicli

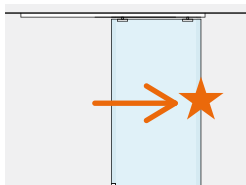

Slam test
GRADO 3
(grado massimo)

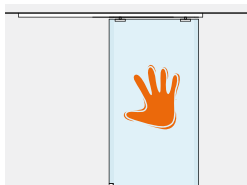

Carico orizzontale
GRADO 3
(grado massimo)

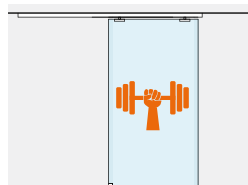

Supera il test di
sovraccarico oltre
200 kg



Performance testate fino a 45.000 cicli di apertura e chiusura



Test di sovraccarico



Pinza interamente in alluminio

LM PORTA PRO

Caratteristiche tecniche

NOVITÀ
2025

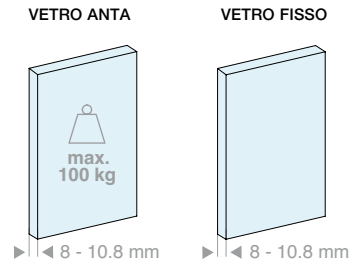
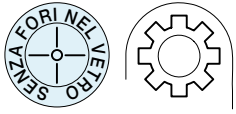

2 tipologie di installazione

Soffitto

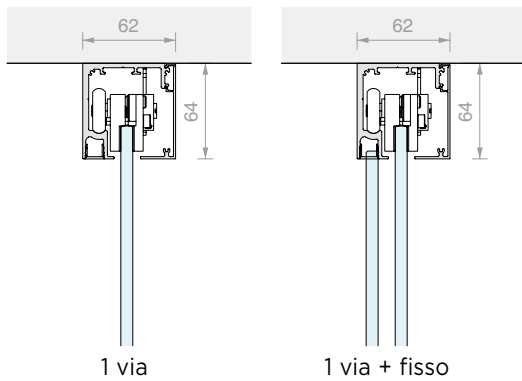

Parete

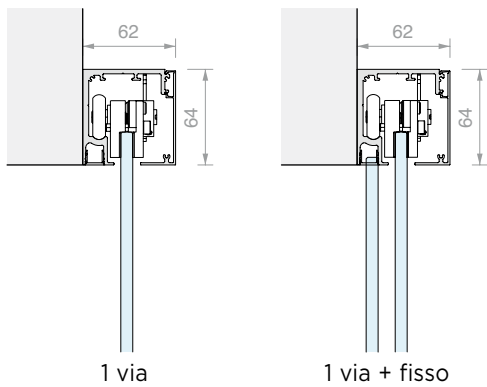

copertina h = 63mm

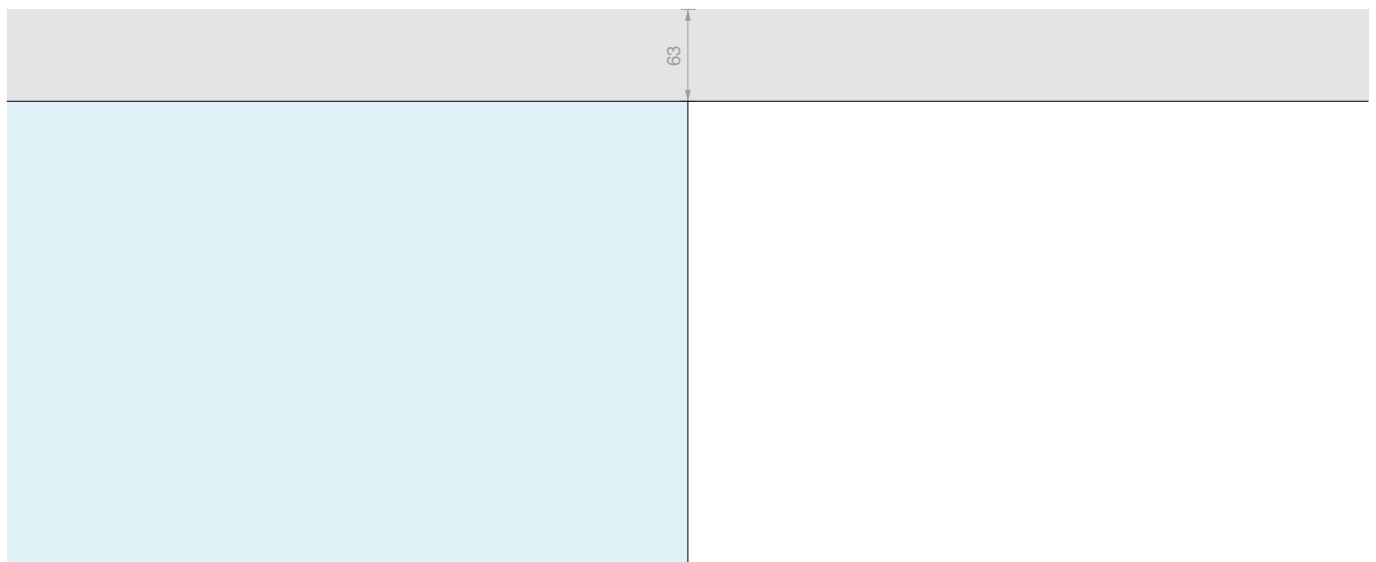

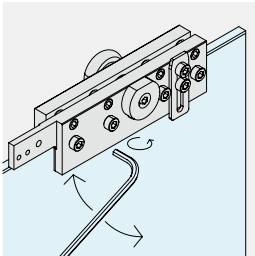
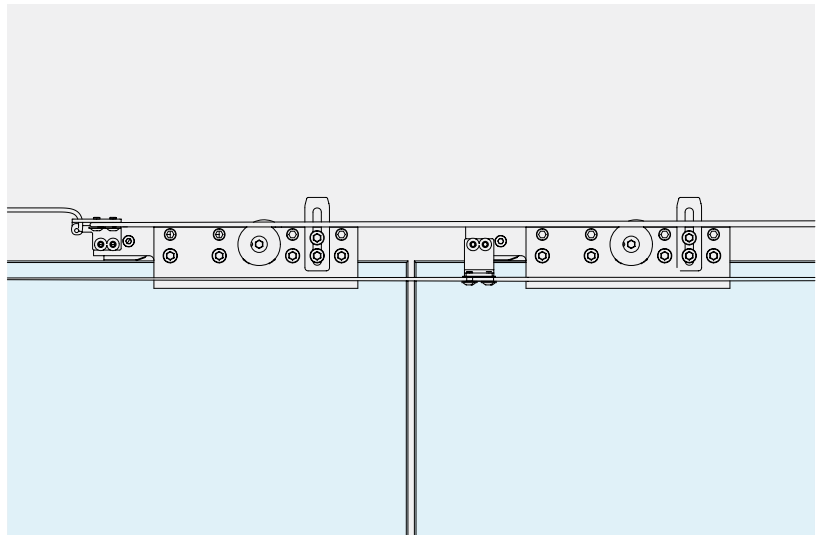
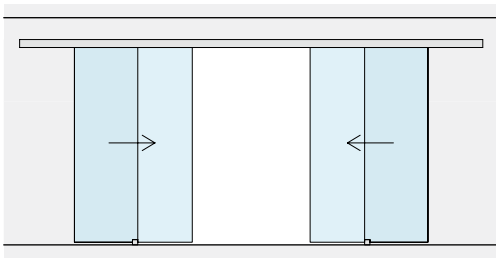

REGOLAZIONE ANTA

E' possibile regolare l'altezza del singolo carrello per registrare la posizione dell'anta di ± 3 mm.

SINCRONISMO

Disponibili accessori per la sincronizzazione concorrente di 2 ante mobili.

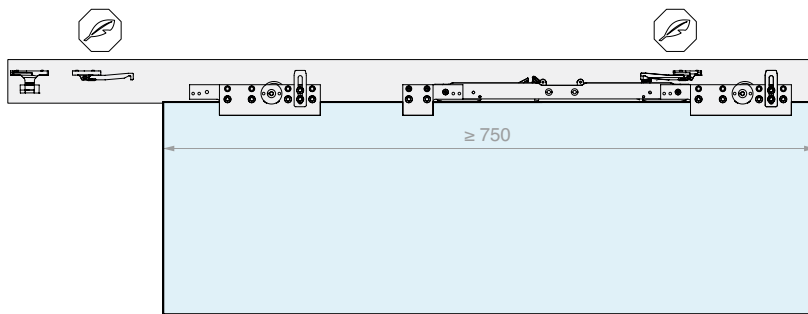

SOFT CLOSE

L'uso di un solo ammortizzatore permette un'apertura e una chiusura controllata e delicata.

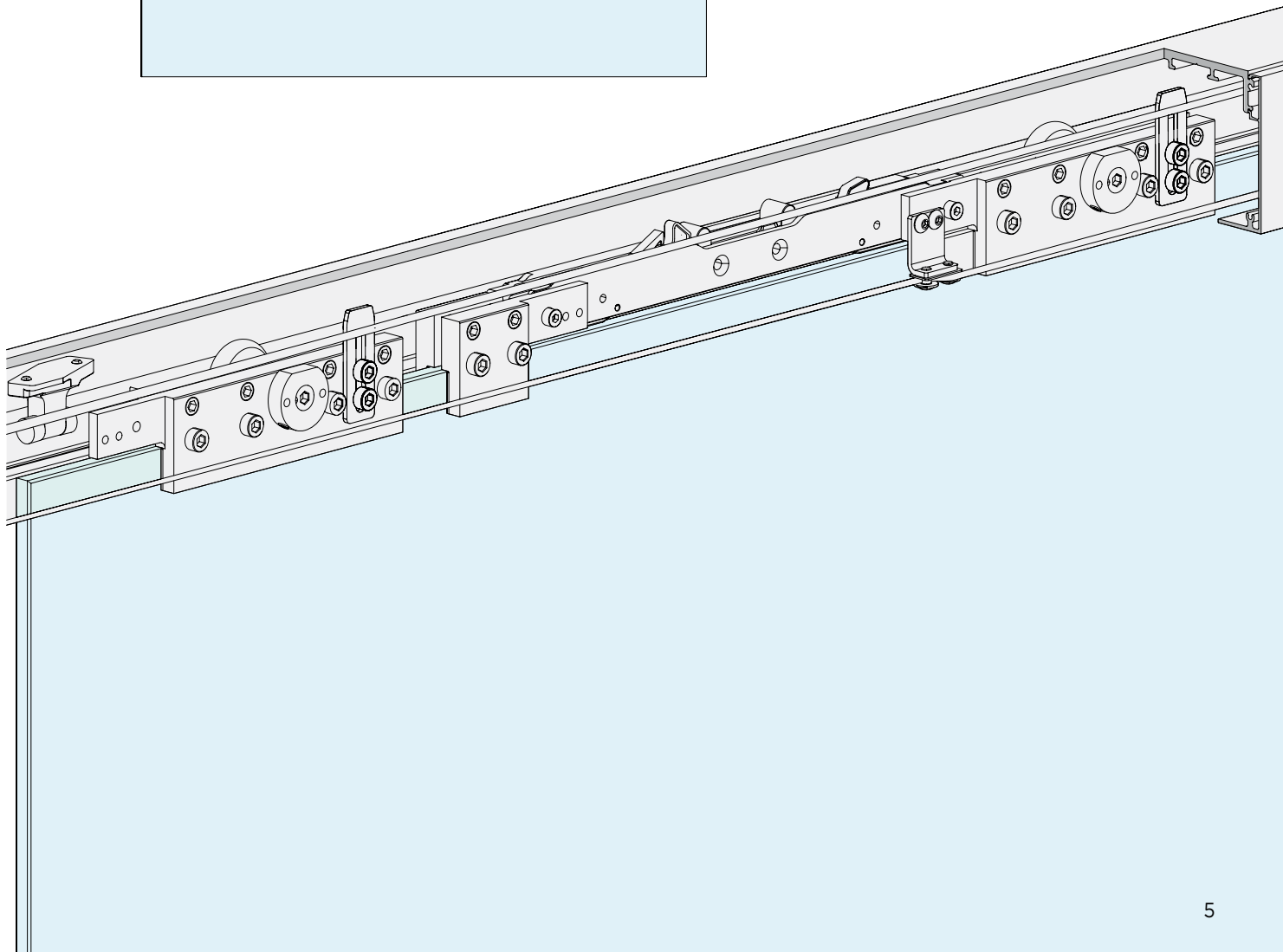



LM PORTA PRO

Kit

INSTALLAZIONE A SOFFITTO

ANTE MOBILI

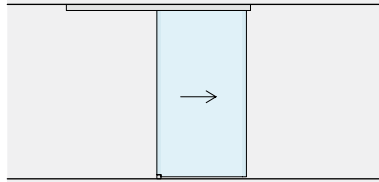

Pag 8

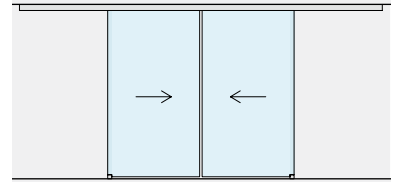

Pag 12

ANTE MOBILI
CON VETRI FISSI

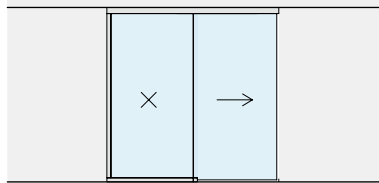

Pag 16

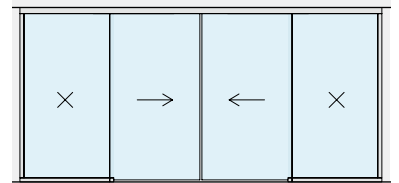

Pag 20

INSTALLAZIONE A PARETE

ANTE MOBILI

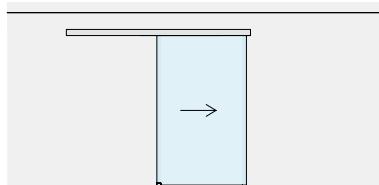

Pag 24

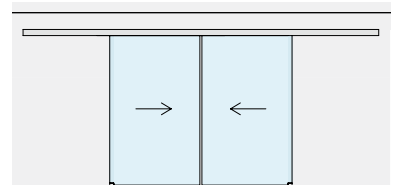

Pag 26

ANTE MOBILI
CON VETRI FISSI

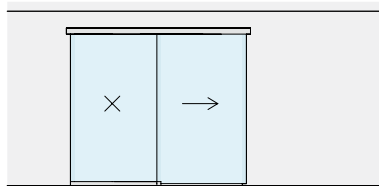

Pag 30

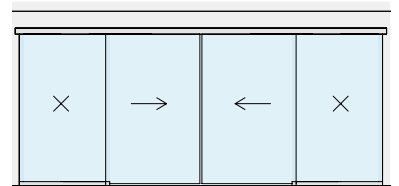

Pag 32



KIT SCORREVOLE FISSAGGIO A SOFFITTO ANTA SINGOLA

Materiale: Alluminio

Finitura: /6 /88 /97

NOVITÀ
2025

DIMENSIONI VANO

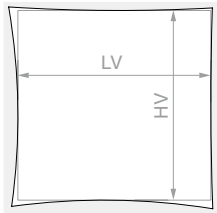

HV max: 3000 mm

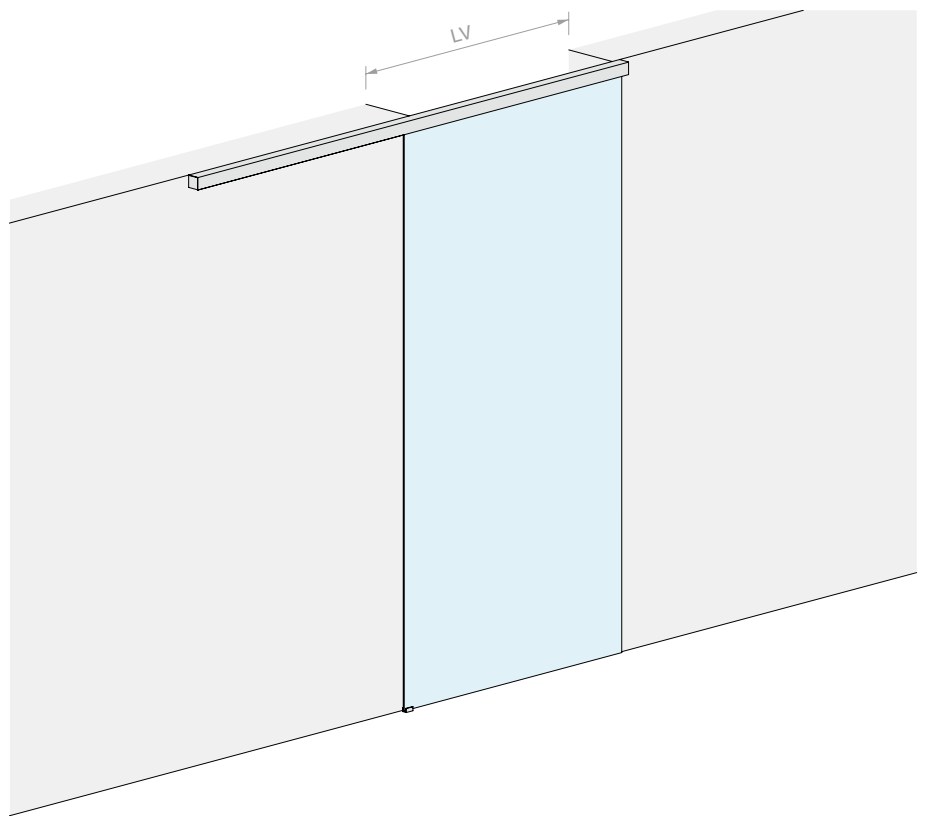

VETRO ANTA



8 - 10.8 mm

VETRO ANTA



8 - 10.8 mm

Kit costituito da:

Art.	Descrizione	Q.tà
LM5864S.200	Binario fissaggio a soffitto	1 Pz
LM0064CP.200	Copertina per binario	1 Pz
LMC13.200	Profilo di finitura	1 Pz
LM63061TP33	Tappo di finitura	2 Pz
CERPOS162	Pinza	2 Pz
LMPS-STP55	Stop senza fermo	2 Pz
LMGF	Guida a terra	1 Pz

Optional

LMDMP070ZKIT	Kit ammortizzatore da 40-70 kg a doppia azione	1 Pz
LMDMP100ZKIT	Kit ammortizzatore da 70-100 kg a doppia azione	1 Pz

Kit costituito da:

Art.	Descrizione	Q.tà
LM5864S.300	Binario fissaggio a soffitto	1 Pz
LM0064CP.300	Copertina per binario	1 Pz
LMC13.300	Profilo di finitura	1 Pz
LM63061TP33	Tappo di finitura	2 Pz
CERPOS162	Pinza	2 Pz
LMPS-STP55	Stop senza fermo	2 Pz
LMGF	Guida a terra	1 Pz

Optional

LMDMP070ZKIT	Kit ammortizzatore da 40-70 kg a doppia azione	1 Pz
LMDMP100ZKIT	Kit ammortizzatore da 70-100 kg a doppia azione	1 Pz

Art.	LV max	Q.tà
LMP6511P.200	920 mm	1 Pz

Art.	LV max	Q.tà
LMP6511P.300	1420 mm	1 Pz

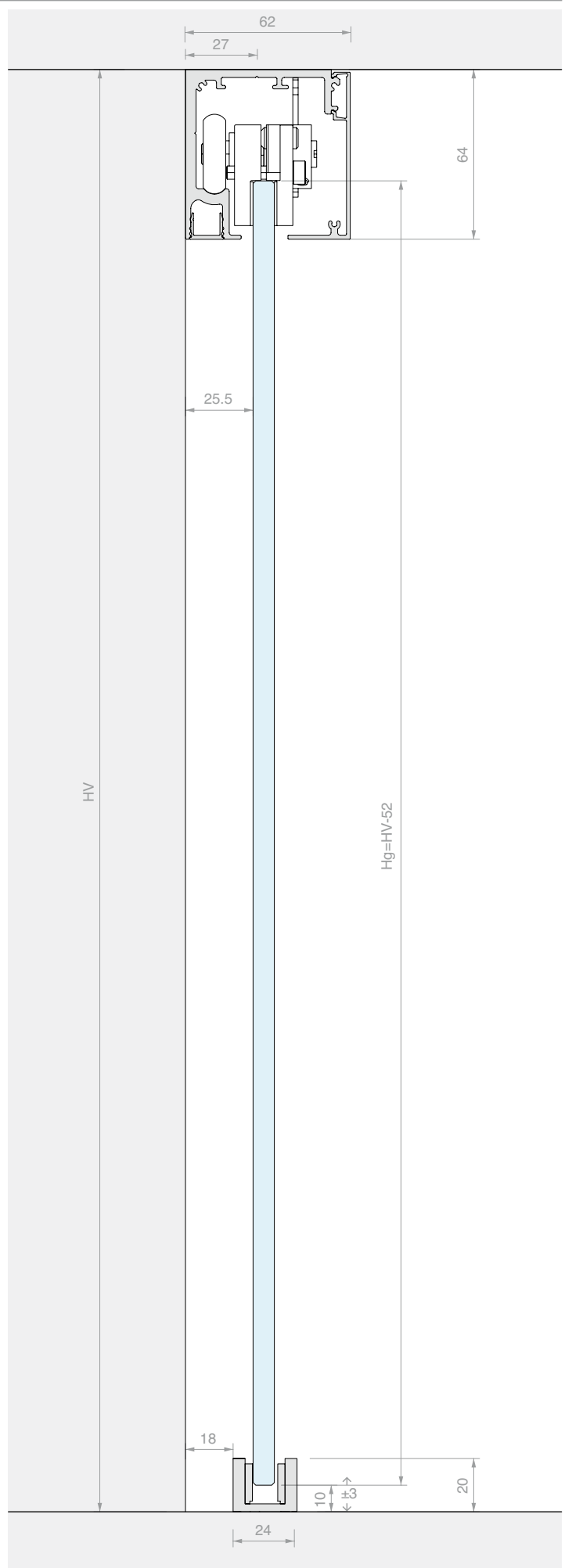
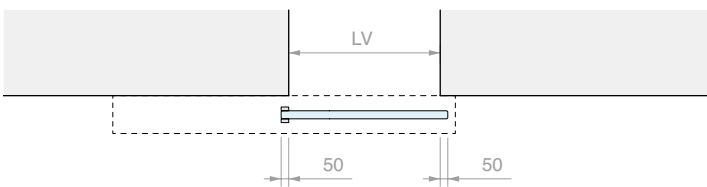
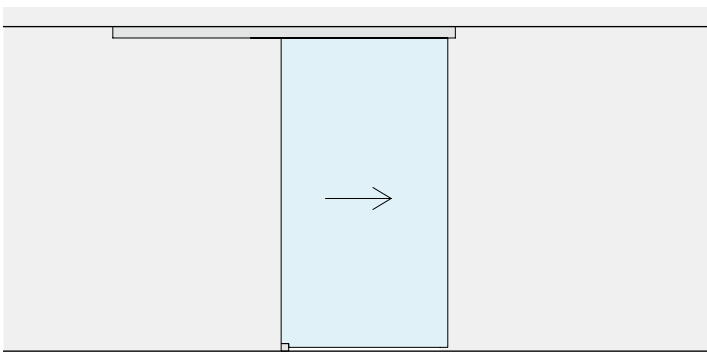
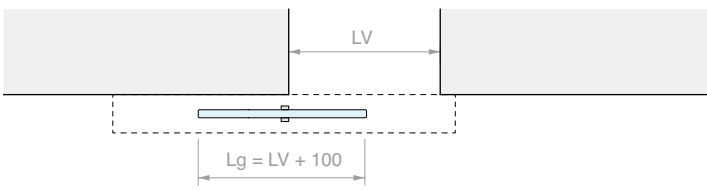
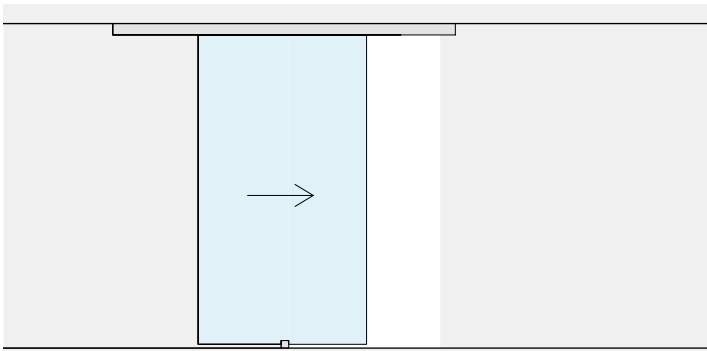
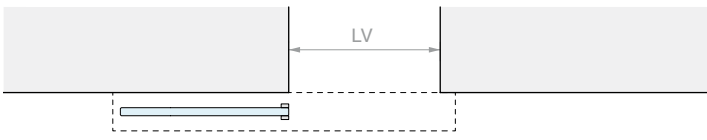
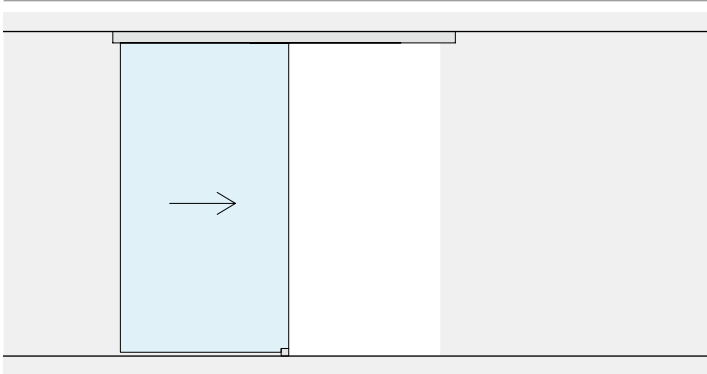







KIT SCORREVOLE FISSAGGIO A SOFFITTO DOPPIA ANTA SINCRONIZZATA

Materiale: Alluminio

Finitura: /6 /88 /97

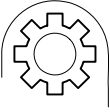
NOVITÀ
2025

DIMENSIONI VANO

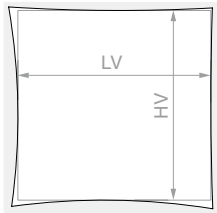

HV max: 3000 mm

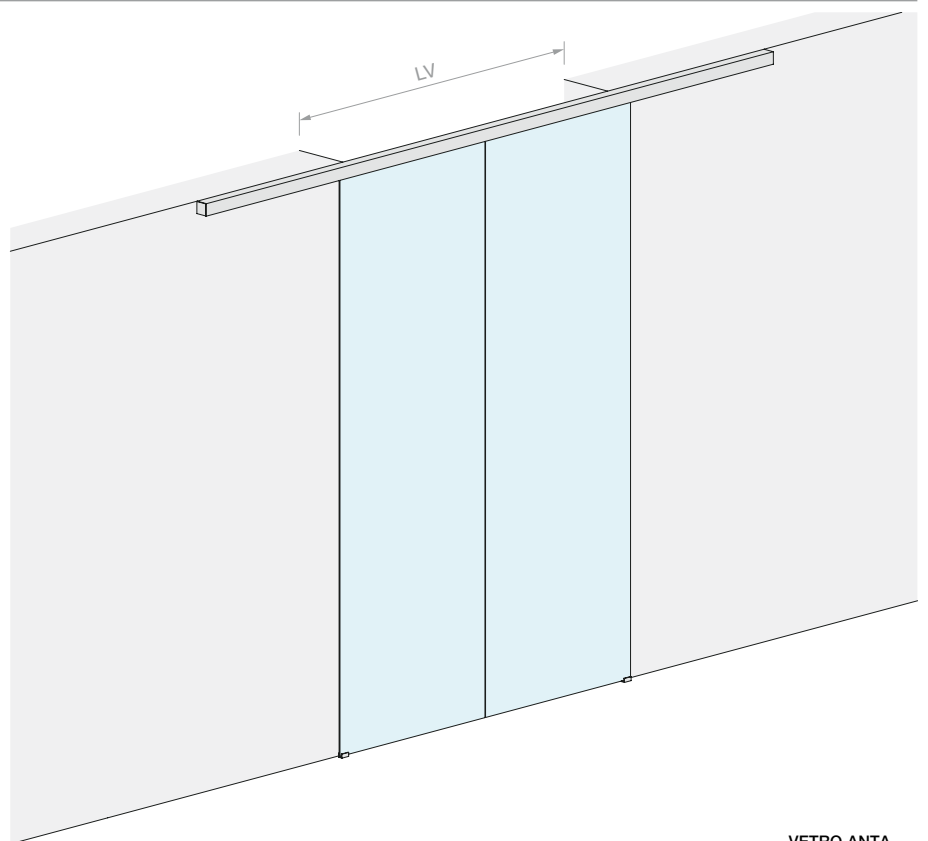

VETRO ANTA



▶ ◀ 8 - 10.8 mm

Kit costituito da:

Art.	Descrizione	Q.tà
LM5864S.400	Binario fissaggio a soffitto	1 Pz
LM0064CP.400	Copertina per binario	1 Pz
LMC13.200	Profilo di finitura	2 Pz
LM63061TP33	Tappo di finitura	2 Pz
CERPOS162	Pinza	4 Pz
LMPS-STP55	Stop senza fermo	4 Pz
LMGF	Guida a terra	2 Pz
LMSIN-AC55	Kit di sincronismo	1 Pz

Optional

LMDMP100ZKIT	Kit ammortizzatore da 35-50 kg a doppia azione	1 Pz
---------------------	--	------

Art.	LV max	Q.tà
LMP6511CP.400	1940 mm	1 Pz

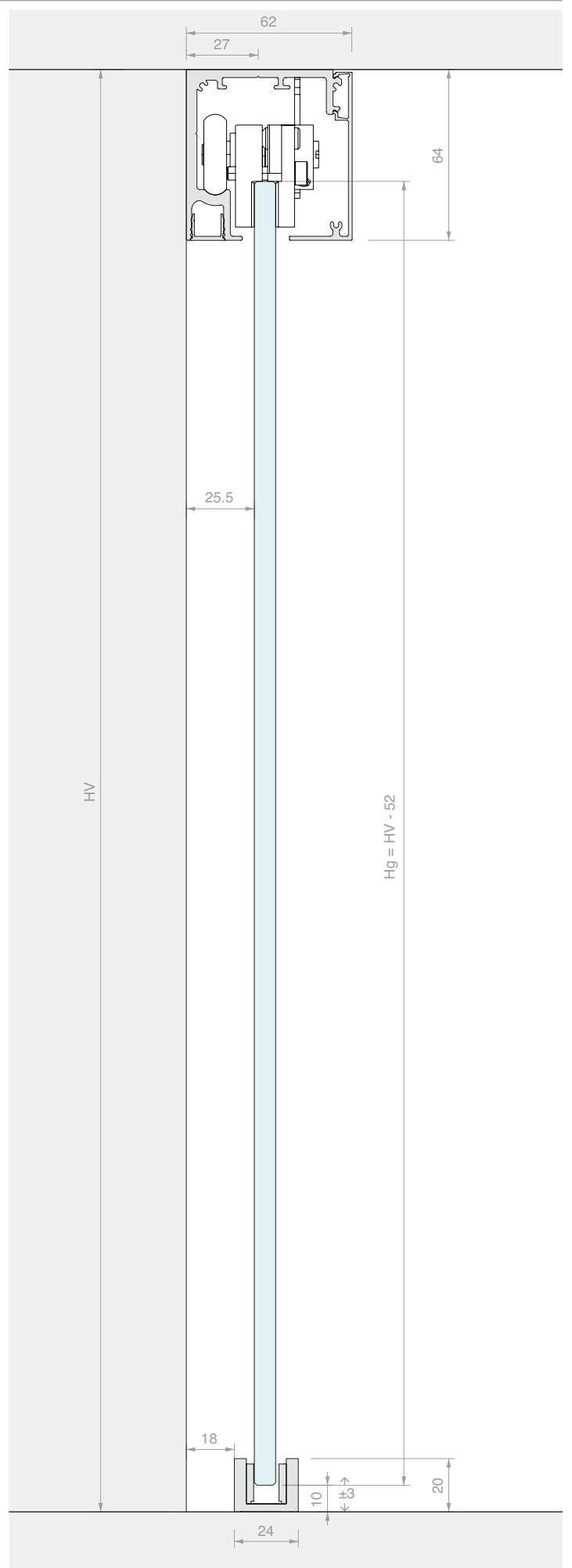
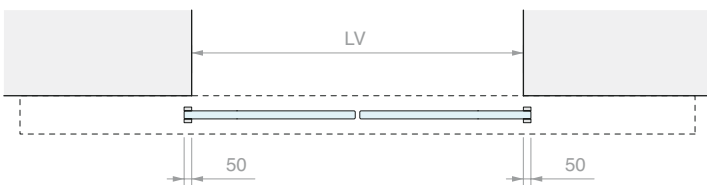
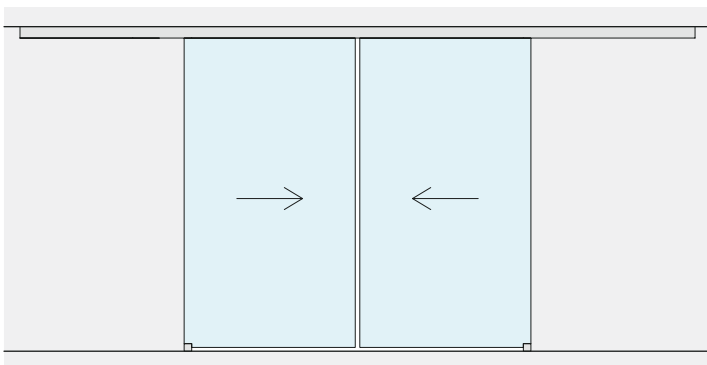
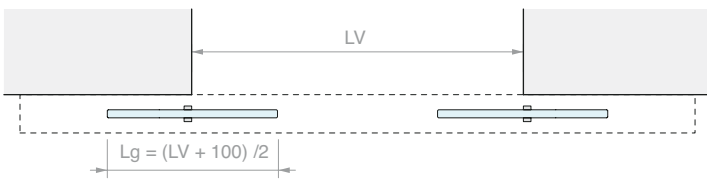
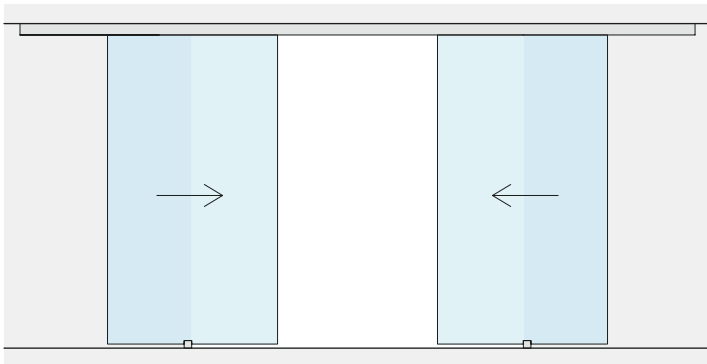
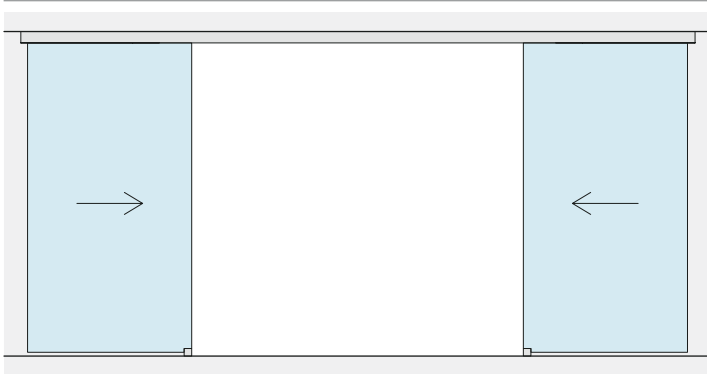







KIT SCORREVOLE FISSAGGIO A SOFFITTO ANTA SINGOLA E VETRO FISSO

Materiale: Alluminio

Finitura: /6 /88 /97

NOVITÀ
2025

DIMENSIONI VANO

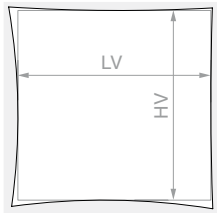

HV max: 3000 mm

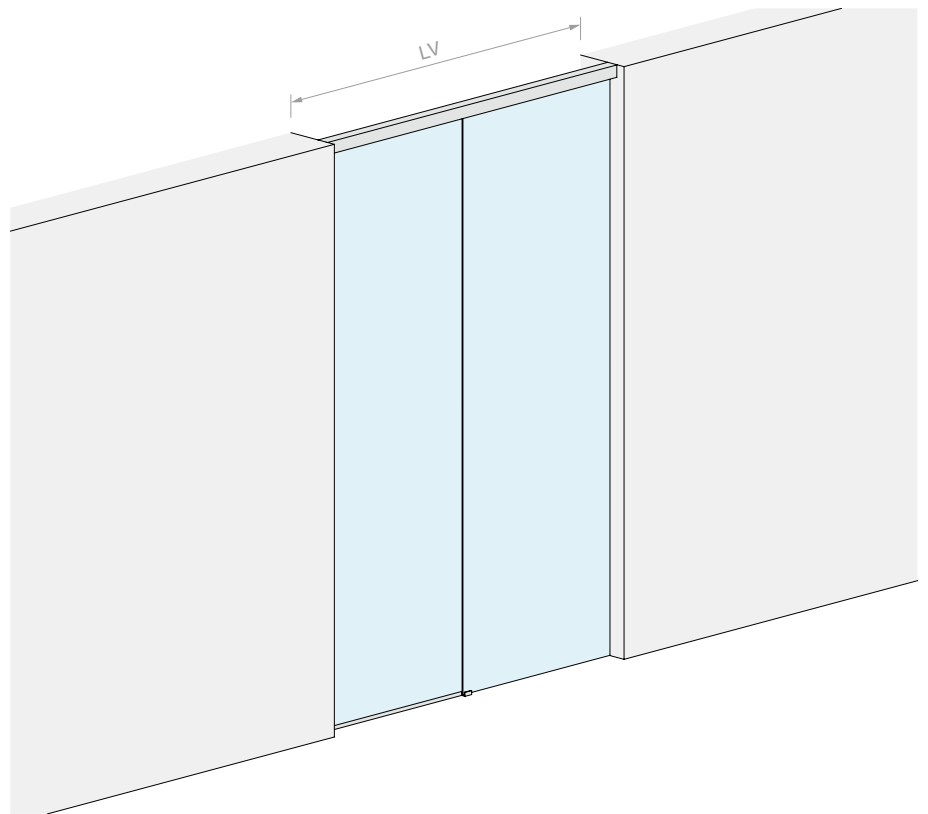

VETRO ANTA

VETRO FISSO

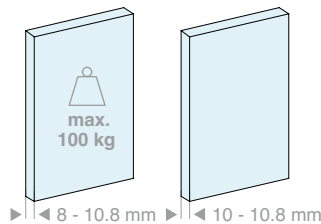

VETRO ANTA

VETRO FISSO

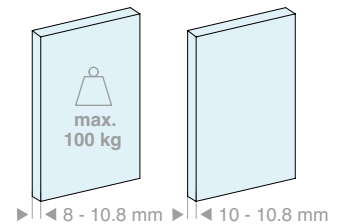

Kit costituito da:

Art.	Descrizione	Q.tà
LM5864S.200	Binario fissaggio a soffitto	1 Pz
LM0064CP.200	Copertina per binario	1 Pz
LMC13.100	Profilo di finitura	1 Pz
LMU20.300	Profilo a "U"	1 Pz
LMU20.150	Profilo a "U"	1 Pz
LMU20TP	Tappo di finitura	1 Pz
CERPOS162	Pinza	2 Pz
LMPS-STP55	Stop senza fermo	2 Pz
GTUP2	Guarnizione fermavetro	5 m
LMGF	Guida a terra	1 Pz

Optional

LMDMP070ZKIT	Kit ammortizzatore da 40-70 kg a doppia azione	1 Pz
LMDMP100ZKIT	Kit ammortizzatore da 70-100 kg a doppia azione	1 Pz

Kit costituito da:

Art.	Descrizione	Q.tà
LM5864S.300	Binario fissaggio a soffitto	1 Pz
LM0064CP.300	Copertina per binario	1 Pz
LMC13.200	Profilo di finitura	1 Pz
LMU20.300	Profilo a "U"	2 Pz
LMU20TP	Tappo di finitura	1 Pz
CERPOS162	Pinza	2 Pz
LMPS-STP55	Stop senza fermo	2 Pz
GTUP2	Guarnizione fermavetro	5 m
LMGF	Guida a terra	1 Pz

Optional

LMDMP070ZKIT	Kit ammortizzatore da 40-70 kg a doppia azione	1 Pz
LMDMP100ZKIT	Kit ammortizzatore da 70-100 kg a doppia azione	1 Pz

Art.	LV max	Q.tà
LMP6511FP.200	2000 mm	1 Pz

Art.	LV max	Q.tà
LMP6511FP.300	3000 mm	1 Pz

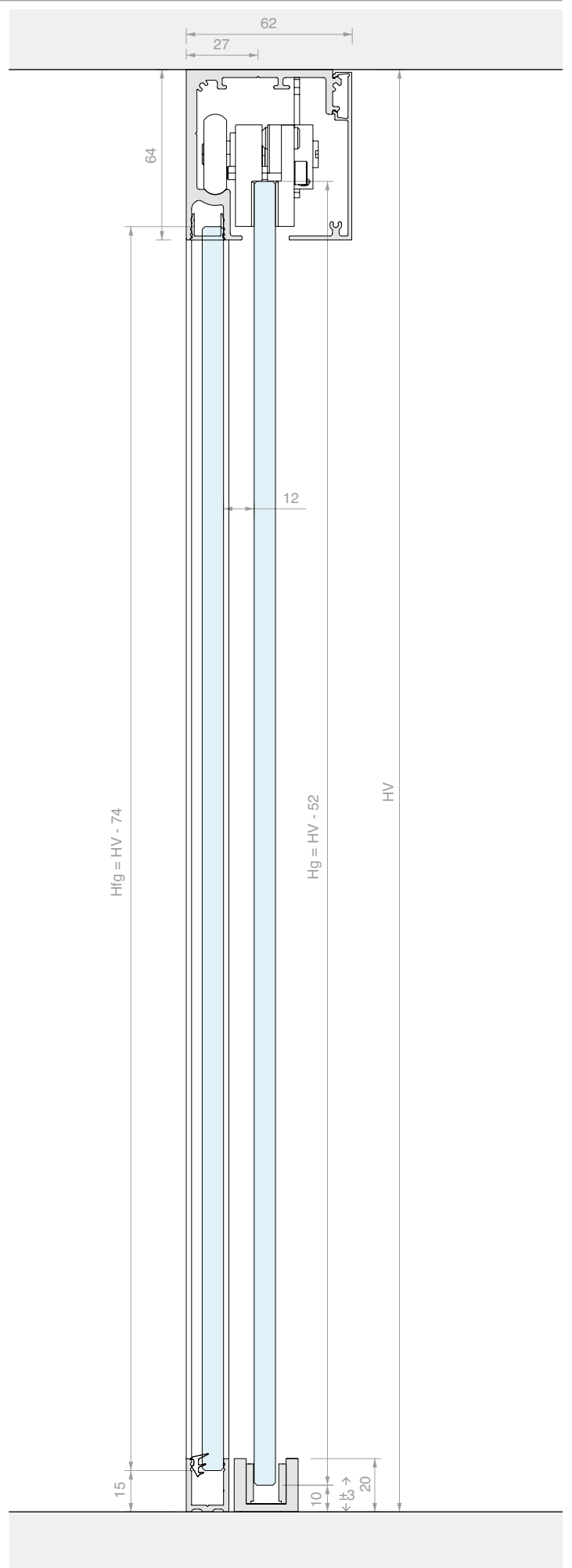
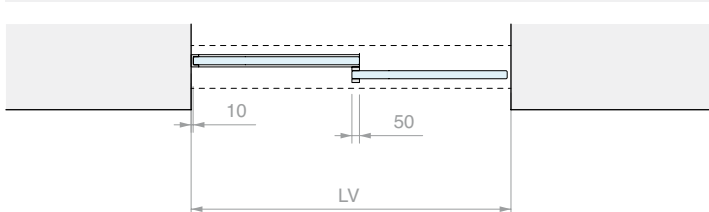
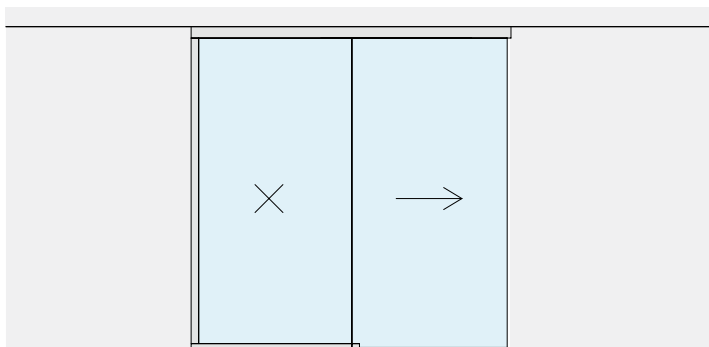
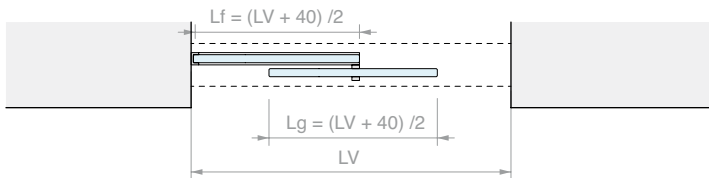
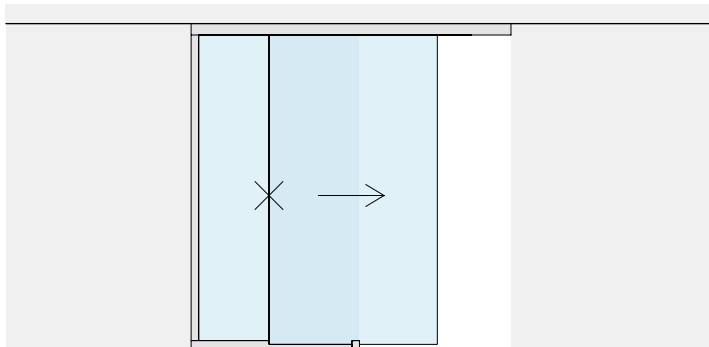
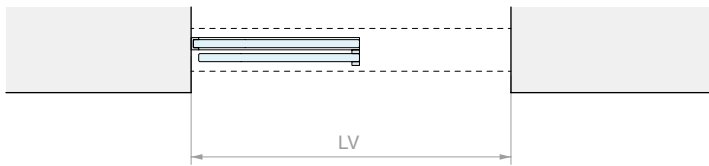
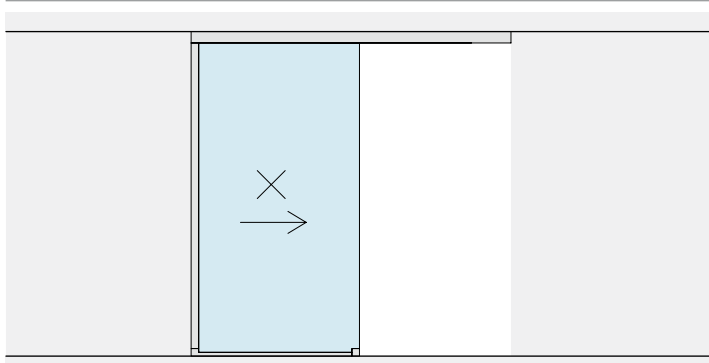







KIT SCORREVOLE FISSAGGIO A SOFFITTO DOPPIA ANTA SINCRONIZZATA E DOPPIO FISSO

Materiale: Alluminio

Finitura: /6 /88 /97

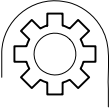
NOVITÀ
2025

DIMENSIONI VANO

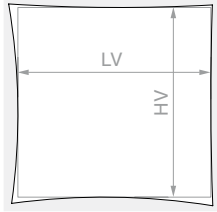

HV max: 3000 mm

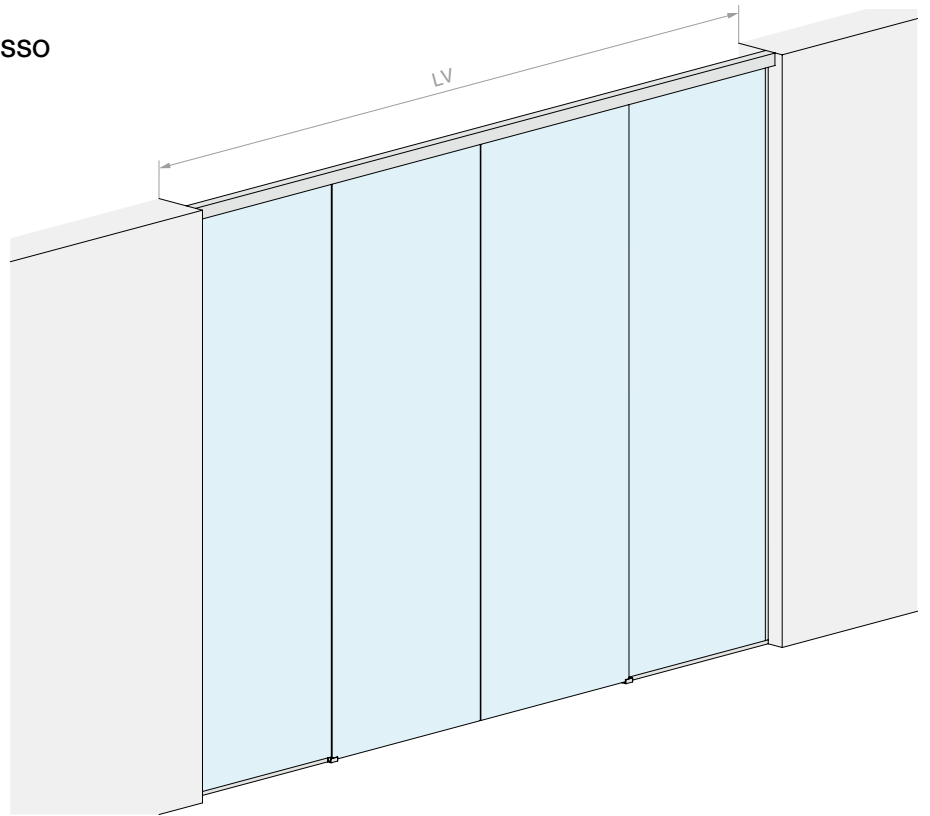

VETRO ANTA

VETRO FISSO

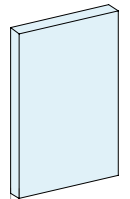

▶ 8 - 10.8 mm ▶ 10 - 10.8 mm

Kit costituito da:

Art.	Descrizione	Q.tà
LM5864S.400	Binario fissaggio a soffitto	1 Pz
LM0064CP.400	Copertina per binario	1 Pz
LMC13.200	Profilo di finitura	1 Pz
LMU20.300	Profilo a "U"	2 Pz
LMU20.150	Profilo a "U"	2 Pz
LMU20TP	Tappo di finitura	2 Pz
CERPOS162	Pinza	4 Pz
LMPS-STP55	Stop senza fermo	4 Pz
GTUP2	Guarnizione fermavetro	10 m
LMGF	Guida a terra	2 Pz
LMSIN-AC55	Kit di sincronismo	1 Pz

Optional

LMDMP100ZKIT	Kit ammortizzatore da 35-50 kg a doppia azione	1 Pz
---------------------	--	------

Art.	LV max	Q.tà
LMP6511CFP.400	4000 mm	1 Pz

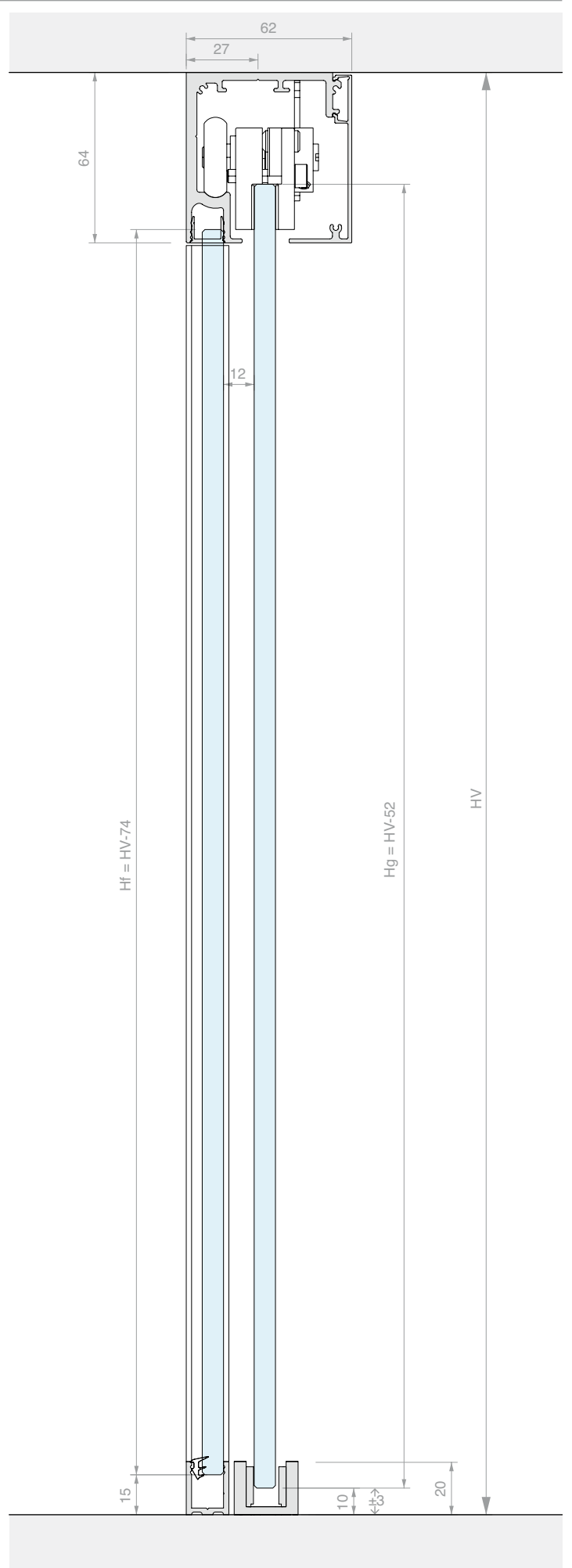
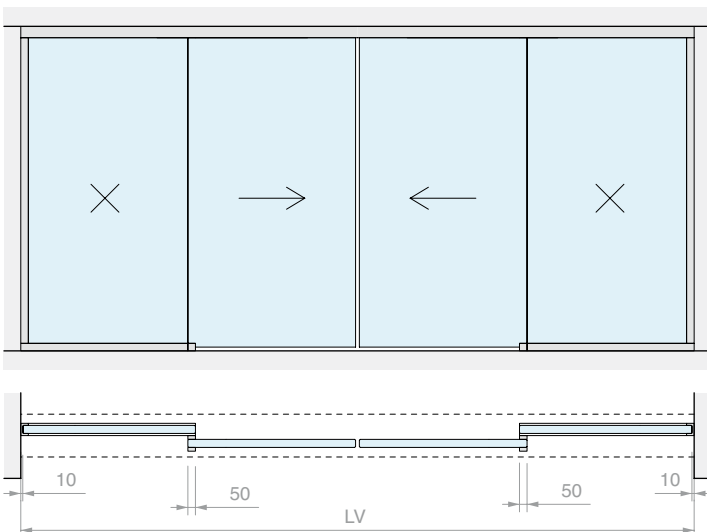
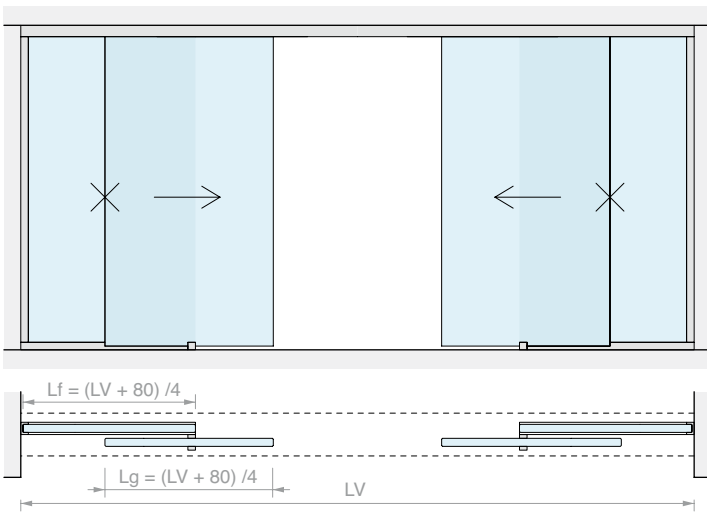
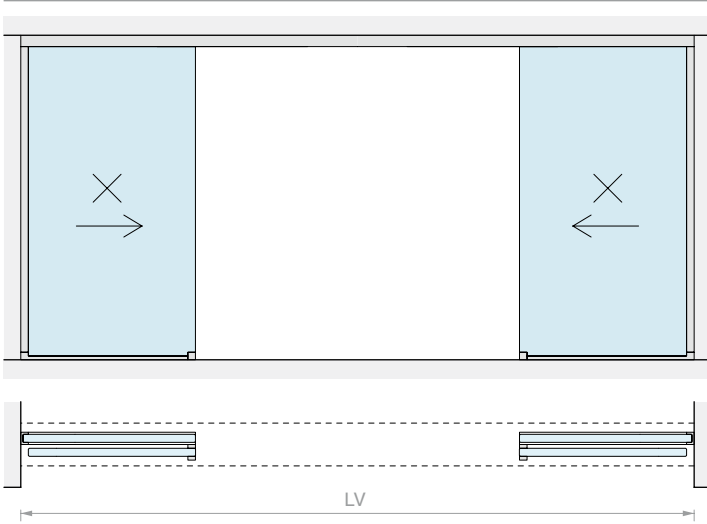







KIT SCORREVOLE FISSAGGIO A PARETE ANTA SINGOLA

Materiale: Alluminio

Finitura: /6 /88 /97

NOVITÀ
2025

DIMENSIONI VANO

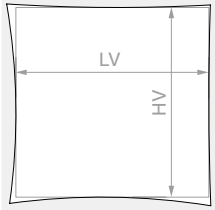

HV max: 3000 mm

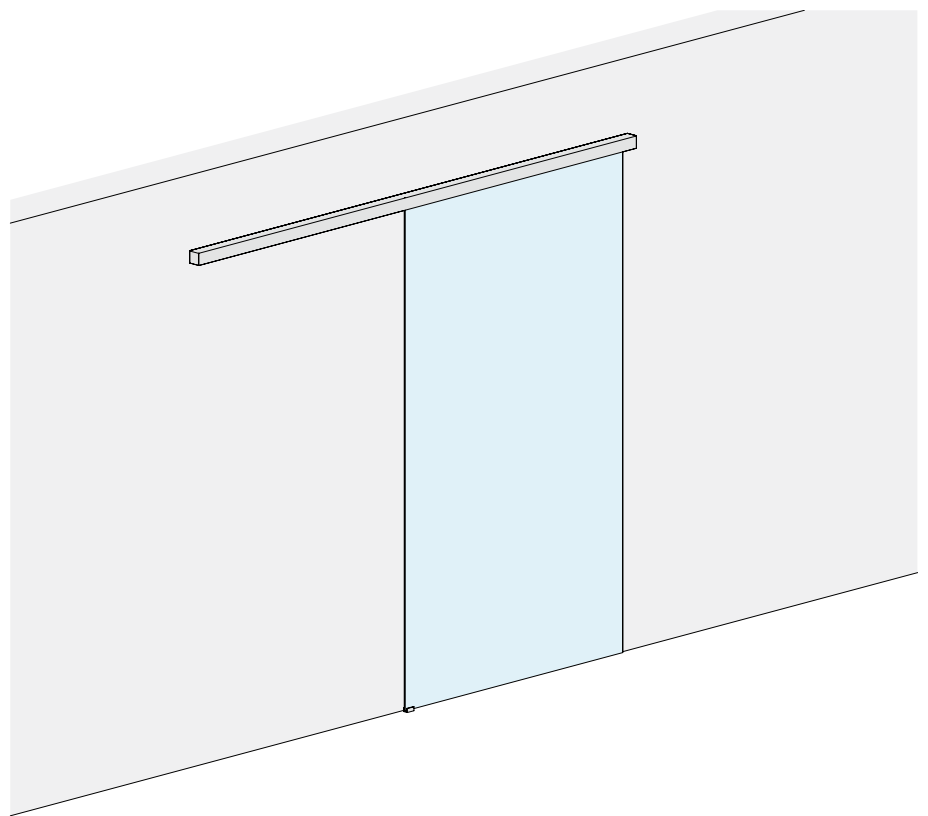

VETRO ANTA



▶ ◀ 8 - 10.8 mm

VETRO ANTA



▶ ◀ 8 - 10.8 mm

Kit costituito da:

Art.	Descrizione	Q.tà
LM5864P.200	Binario fissaggio a parete	1 Pz
LM0064CP.200	Copertina per binario	1 Pz
LMC13.200	Profilo di finitura	1 Pz
LM63061TP33	Tappo di finitura	2 Pz
CERPOS162	Pinza	2 Pz
LMPS-STP55	Stop senza fermo	2 Pz
LMGF	Guida a terra	1 Pz

Optional

LMDMP070ZKIT	Kit ammortizzatore da 40-70 kg a doppia azione	1 Pz
LMDMP100ZKIT	Kit ammortizzatore da 70-100 kg a doppia azione	1 Pz

Kit costituito da:

Art.	Descrizione	Q.tà
LM5864P.300	Binario fissaggio a parete	1 Pz
LM0064CP.300	Copertina per binario	1 Pz
LMC13.300	Profilo di finitura	1 Pz
LM63061TP33	Tappo di finitura	2 Pz
CERPOS162	Pinza	2 Pz
LMPS-STP55	Stop senza fermo	2 Pz
LMGF	Guida a terra	1 Pz

Optional

LMDMP070ZKIT	Kit ammortizzatore da 40-70 kg a doppia azione	1 Pz
LMDMP100ZKIT	Kit ammortizzatore da 70-100 kg a doppia azione	1 Pz

Art.	LV max	Q.tà
LMP6521P.200	920 mm	1 Pz

Art.	LV max	Q.tà
LMP6521P.300	1420 mm	1 Pz

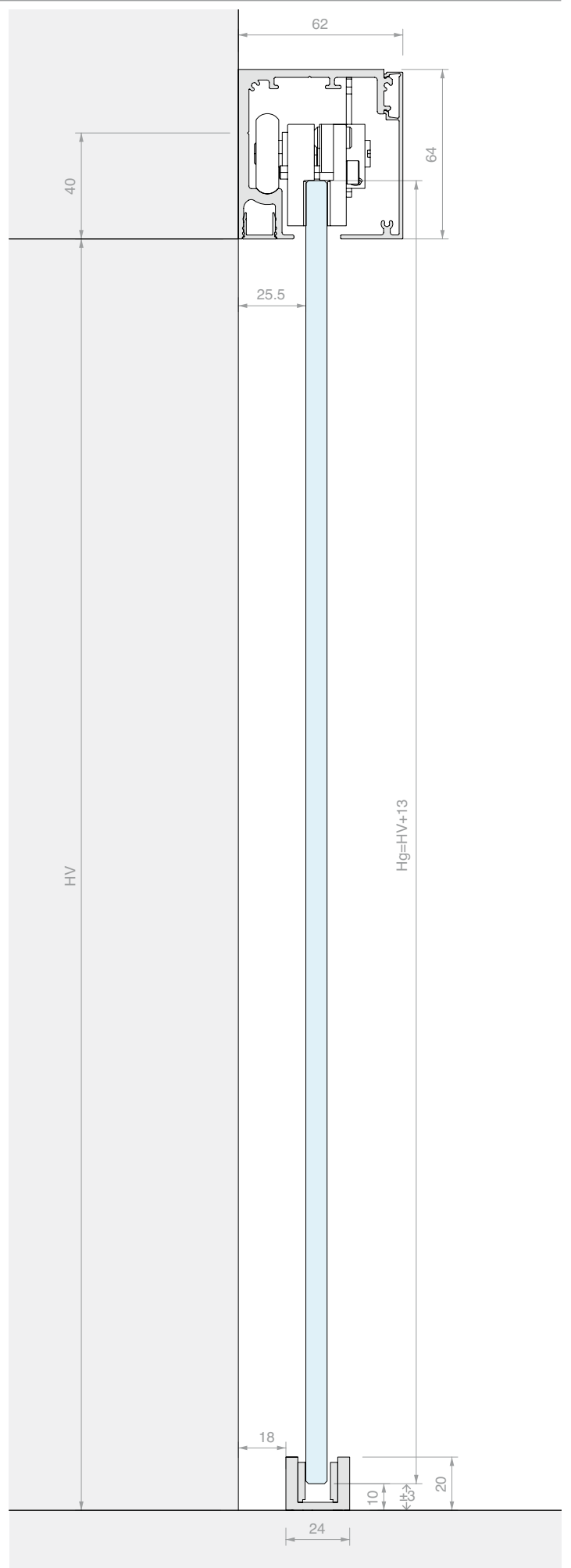
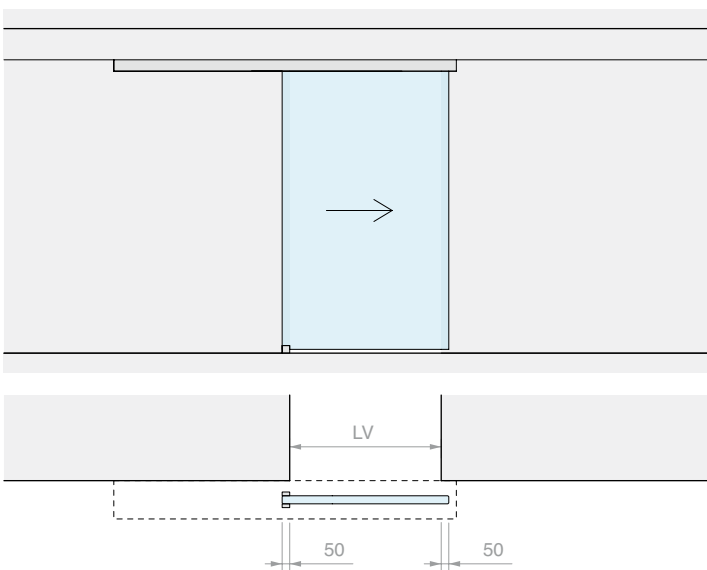
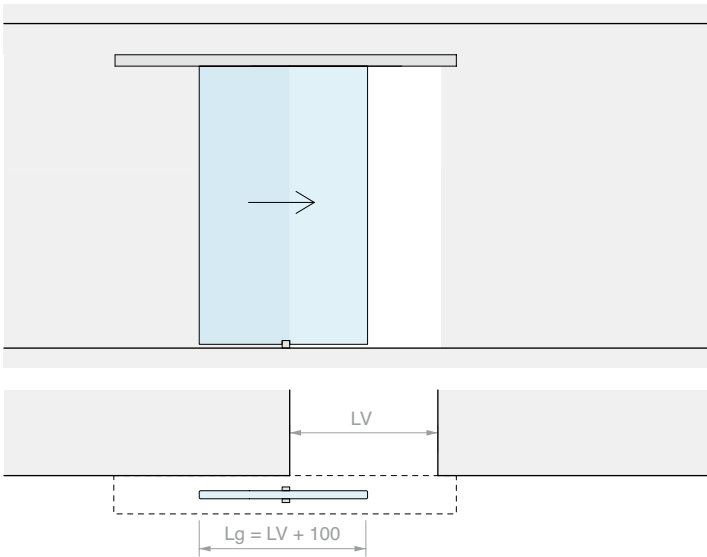
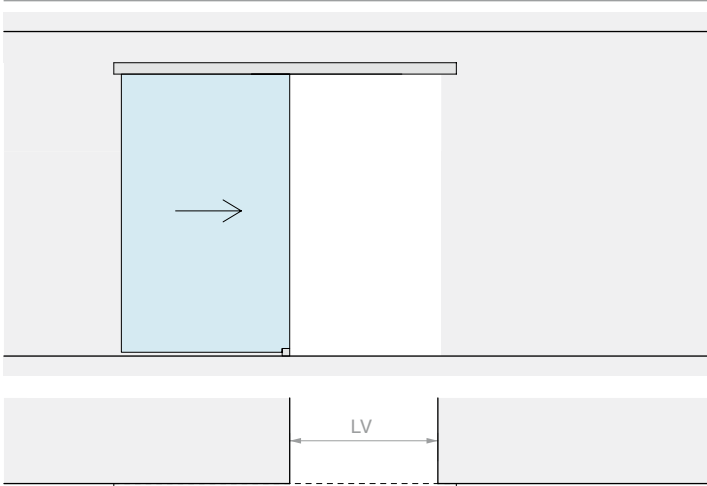



KIT SCORREVOLE FISSAGGIO A PARETE DOPPIA ANTA SINCRONIZZATA

Materiale: Alluminio

Finitura: /6 /88 /97

NOVITÀ
2025

DIMENSIONI VANO

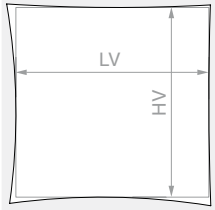

HV max: 3000 mm

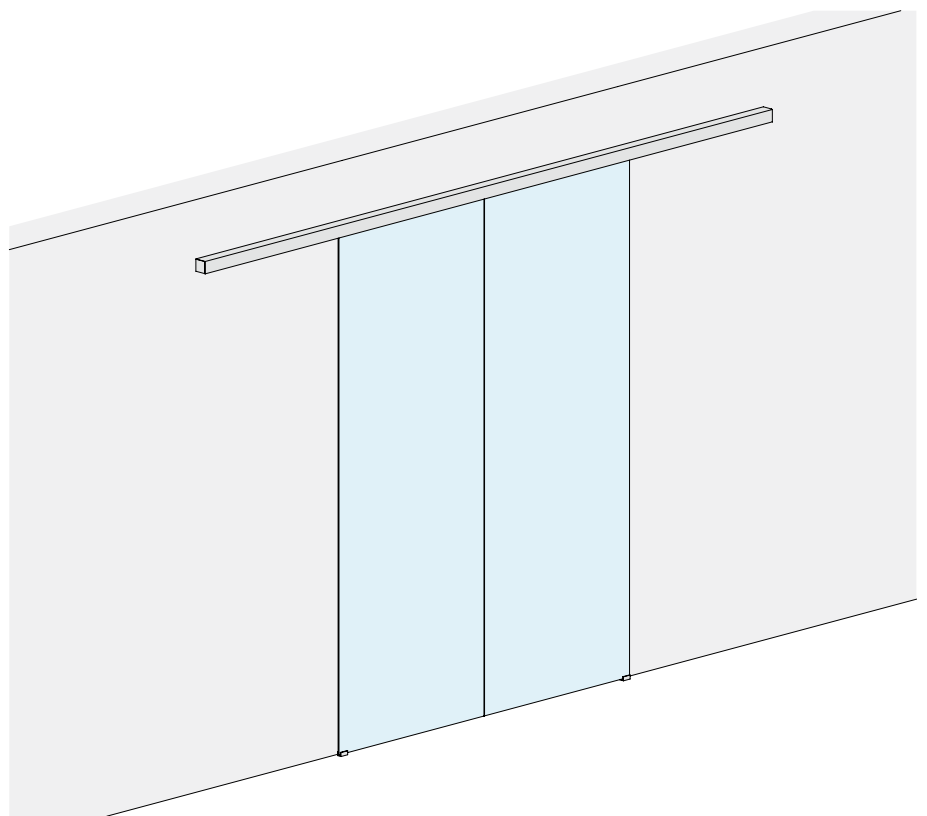

VETRO ANTA



▶ ◀ 8 - 10.8 mm

Kit costituito da:

Art.	Descrizione	Q.tà
LM5864P.400	Binario fissaggio a parete	1 Pz
LM0064CP.400	Copertina per binario	1 Pz
LMC13.200	Profilo di finitura	2 Pz
LM63061TP33	Tappo di finitura	2 Pz
CERPOS162	Pinza	4 Pz
LMPS-STP55	Stop senza fermo	4 Pz
LMGF	Guida a terra	2 Pz
LMSIN-AC55	Kit di sincronismo	1 Pz

Optional

LMDMP100ZKIT	Kit ammortizzatore da 35-50 kg a doppia azione	1 Pz
---------------------	--	------

Art.	LV max	Q.tà
LMP6521CP.400	1940 mm	1 Pz

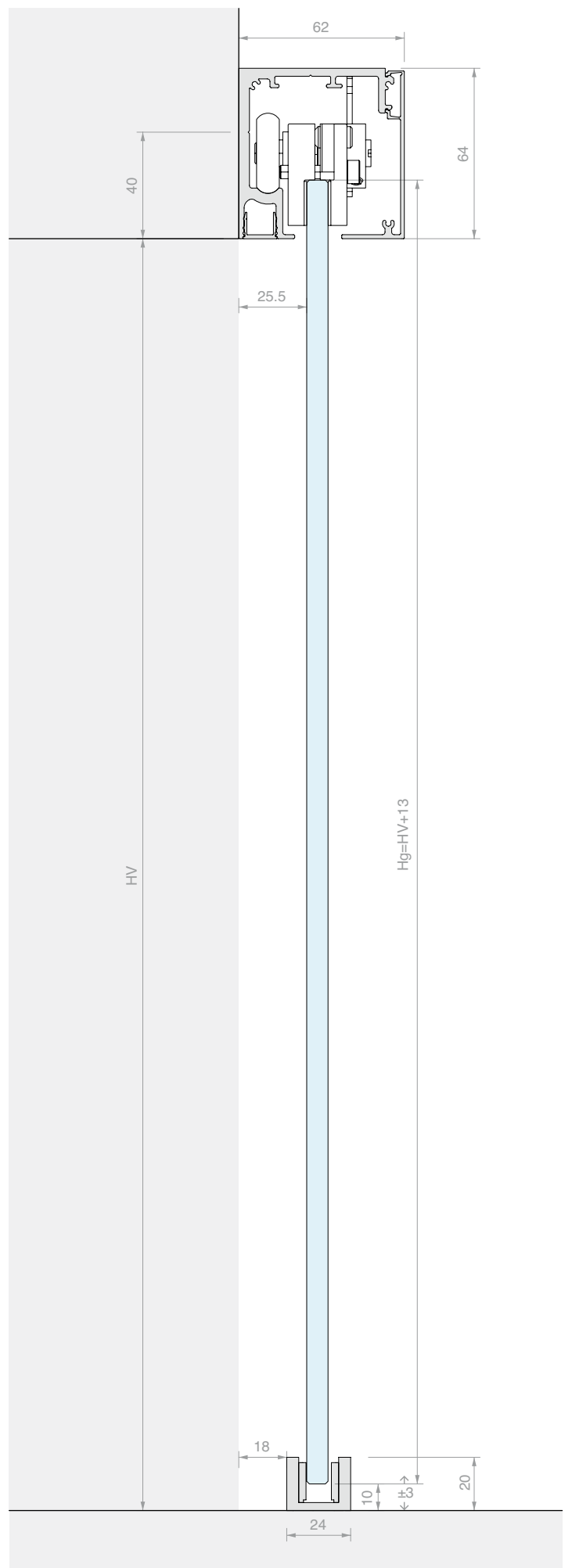
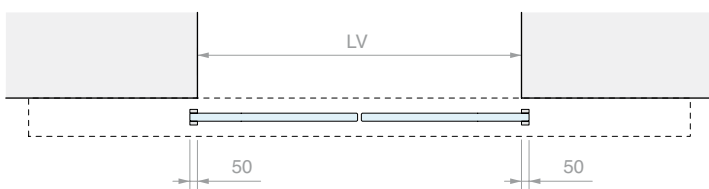
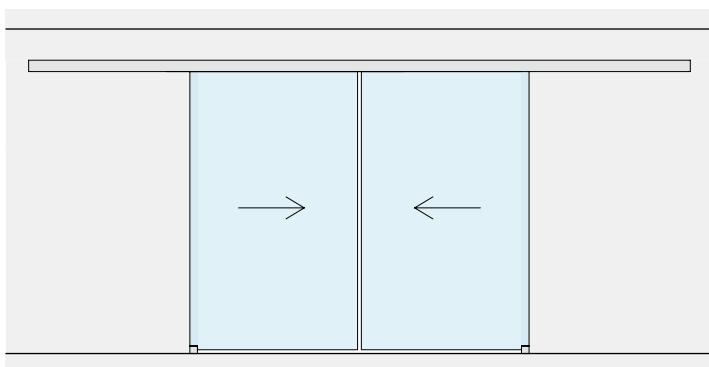
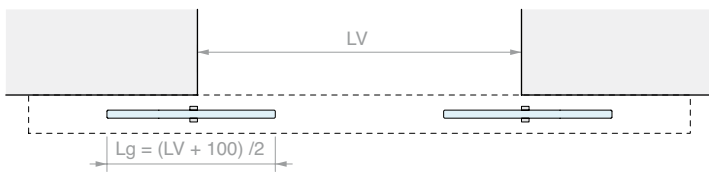
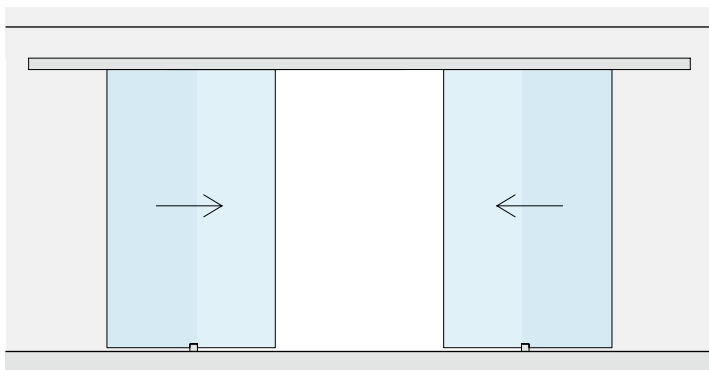
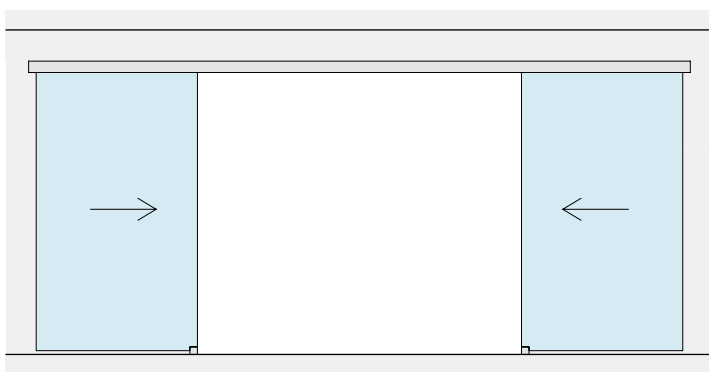







KIT SCORREVOLE FISSAGGIO A PARETE ANTA SINGOLA E VETRO FISSO

Materiale: Alluminio

Finitura: /6 /88 /97

NOVITÀ
2025

DIMENSIONI VANO

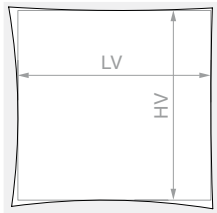

HV max: 3000 mm

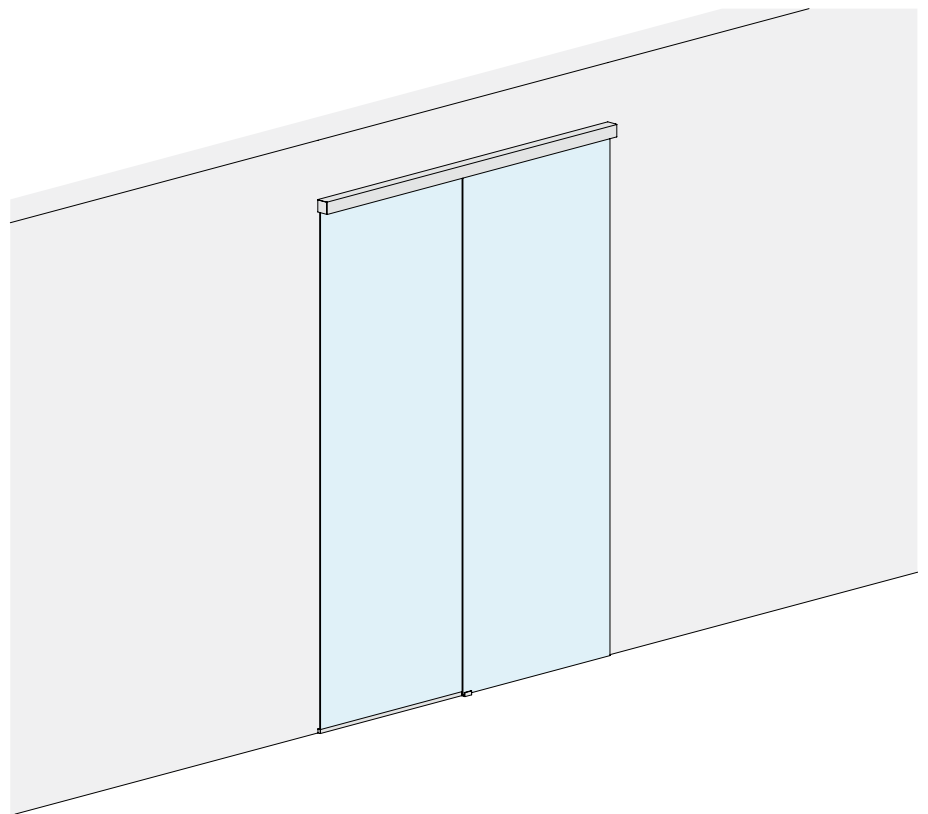

VETRO ANTA

VETRO FISSO

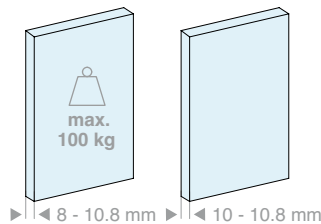

VETRO ANTA

VETRO FISSO

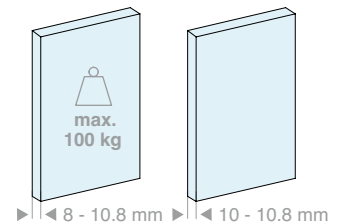

Kit costituito da:

Art.	Descrizione	Q.tà
LM5864P.200	Binario fissaggio a parete	1 Pz
LM0064CP.200	Copertina per binario	1 Pz
LMC13.100	Profilo di finitura	1 Pz
LMU20.150	Profilo a "U"	1 Pz
LM63061TP33	Tappo di finitura	2 Pz
LMU20TP	Tappo di finitura	2 Pz
CERPOS162	Pinza	2 Pz
LMPS-STP55	Stop senza fermo	2 Pz
GTUP2	Guarnizione fermavetro	5 m
LMGF	Guida a terra	1 Pz

Optional

LMDMP070ZKIT	Kit ammortizzatore da 40-70 kg a doppia azione	1 Pz
LMDMP100ZKIT	Kit ammortizzatore da 70-100 kg a doppia azione	1 Pz

Kit costituito da:

Art.	Descrizione	Q.tà
LM5864P.300	Binario fissaggio a parete	1 Pz
LM0064CP.300	Copertina per binario	1 Pz
LMC13.200	Profilo di finitura	1 Pz
LMU20.300	Profilo a "U"	1 Pz
LM63061TP33	Tappo di finitura	2 Pz
LMU20TP	Tappo di finitura	2 Pz
CERPOS162	Pinza	2 Pz
LMPS-STP55	Stop senza fermo	2 Pz
GTUP2	Guarnizione fermavetro	5 m
LMGF	Guida a terra	1 Pz

Optional

LMDMP070ZKIT	Kit ammortizzatore da 40-70 kg a doppia azione	1 Pz
LMDMP100ZKIT	Kit ammortizzatore da 70-100 kg a doppia azione	1 Pz

Art.	LV max	Q.tà
LMP6521FP.200	1880 mm	1 Pz

Art.	LV max	Q.tà
LMP6521FP.300	2880 mm	1 Pz

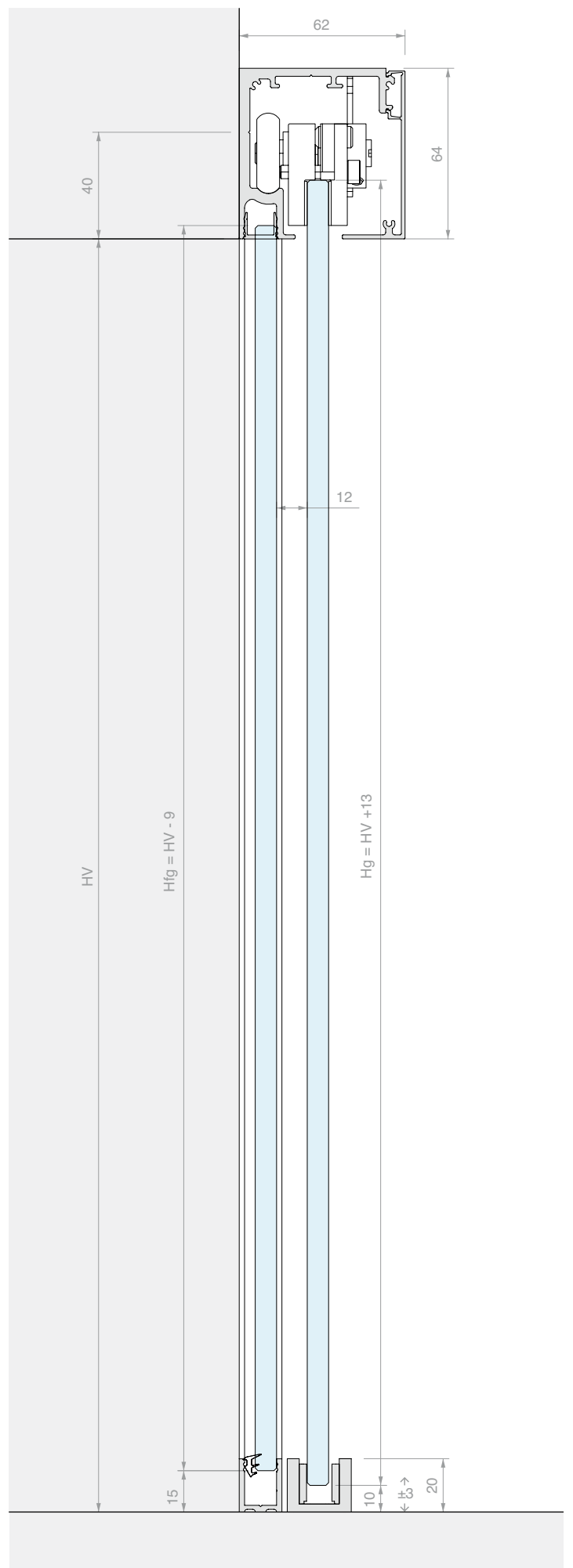
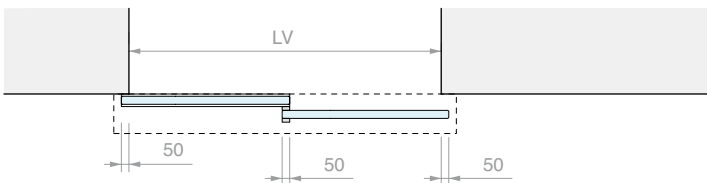
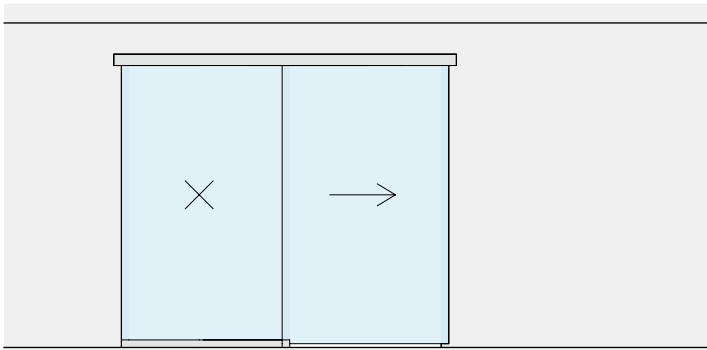
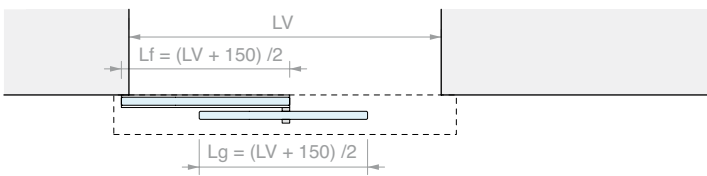
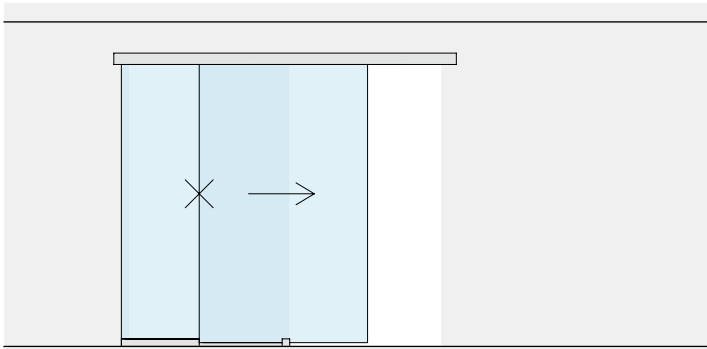
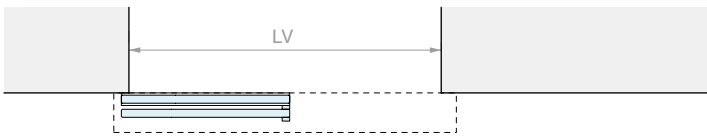
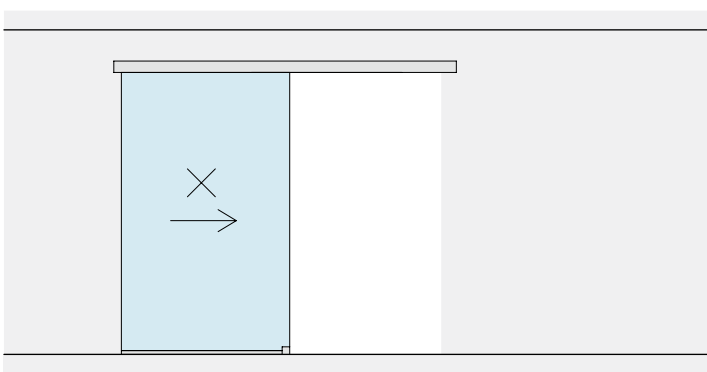



KIT SCORREVOLE FISSAGGIO A PARETE DOPPIA ANTA SINCRONIZZATA E DOPPIO FISSO

Materiale: Alluminio

Finitura: /6 /88 /97

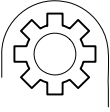
NOVITÀ
2025

DIMENSIONI VANO

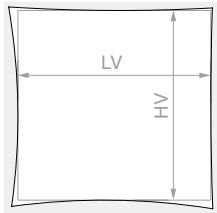

HV max: 3000 mm

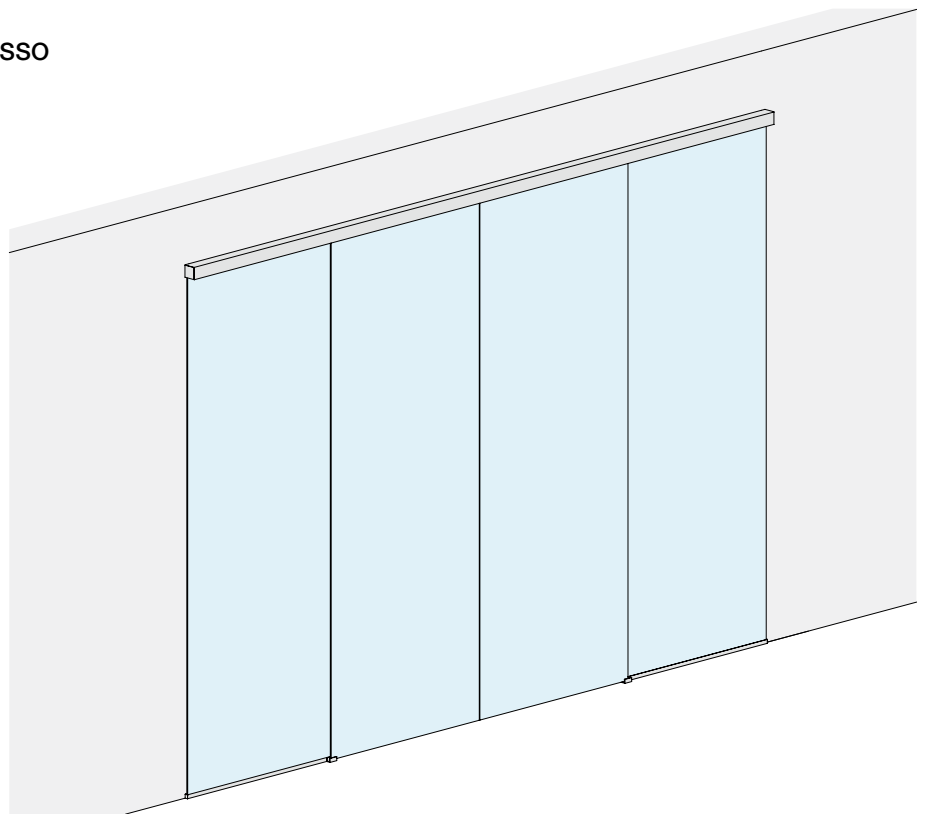

VETRO ANTA

VETRO FISSO

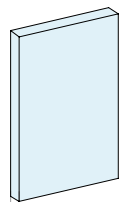

▶ |◀ 8 - 10.8 mm ▶ |◀ 10 - 10.8 mm ▶

Kit costituito da:

Art.	Descrizione	Q.tà
LM5864P.400	Binario fissaggio a parete	1 Pz
LM0064CP.400	Copertina per binario	1 Pz
LMC13.200	Profilo di finitura	1 Pz
LMU20.300	Profilo a "U"	1 Pz
LM63061TP33	Tappo di finitura	2 Pz
LMU20TP	Tappo di finitura	4 Pz
CERPOS162	Pinza	4 Pz
LMPS-STP55	Stop senza fermo	4 Pz
GTUP2	Guarnizione fermavetro	10 m
LMGF	Guida a terra	2 Pz
LMSIN-AC55	Kit di sincronismo	1 Pz

Optional

LMDMP100ZKIT	Kit ammortizzatore da 35-50 kg a doppia azione	1 Pz
---------------------	--	------

Art.	LV max	Q.tà
LMP6521CFP.400	3880 mm	1 Pz

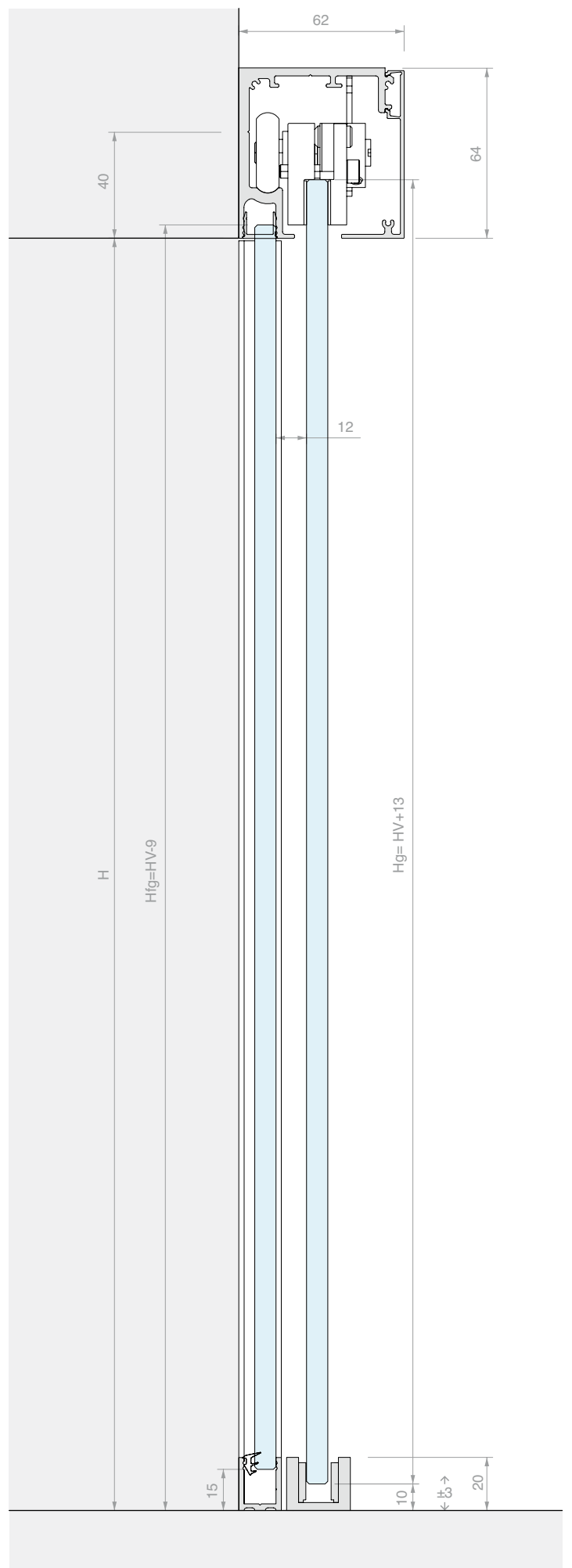
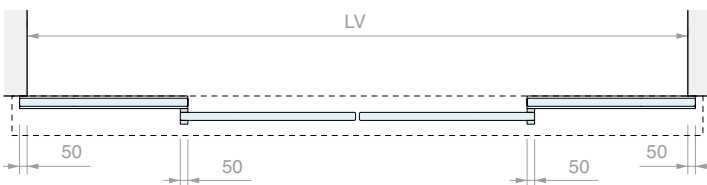
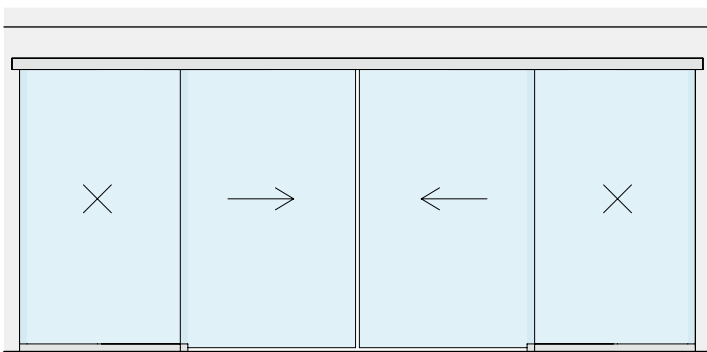
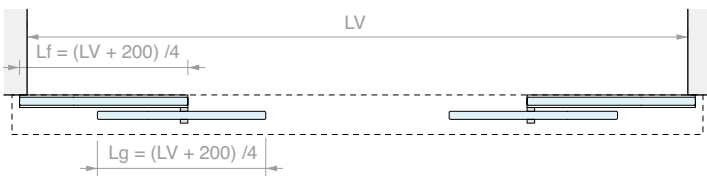
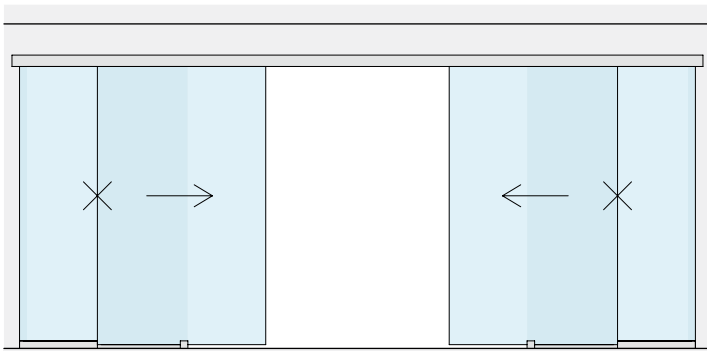
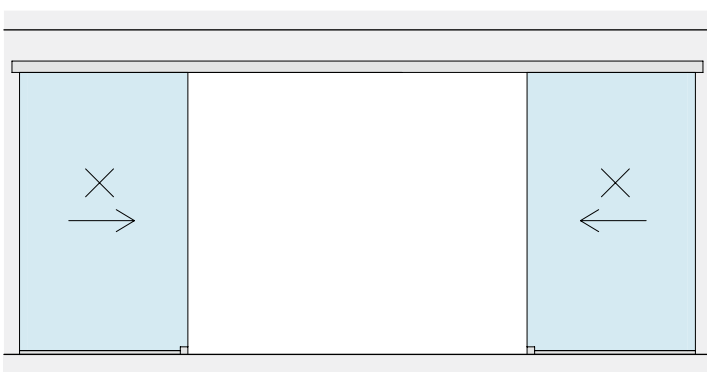



BINARIO FISSAGGIO A SOFFITTO

Materiale: Alluminio

Finitura: /6 /88 /97

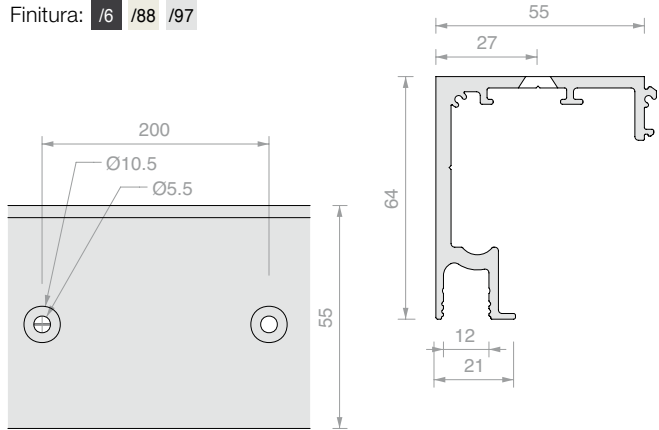

Art.	Lunghezza	Q.tà
LM5864S.200	1998 mm	1 Pz
LM5864S.300	2998 mm	1 Pz
LM5864S.400	3998 mm	1 Pz
LM5864S.600	6000 mm	1 Pz



BINARIO FISSAGGIO A PARETE

Materiale: Alluminio

Finitura: /6 /88 /97

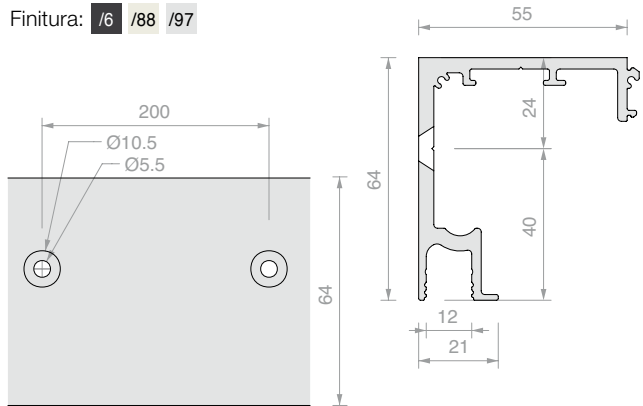

Art.	Lunghezza	Q.tà
LM5864P.200	1998 mm	1 Pz
LM5864P.300	2998 mm	1 Pz
LM5864P.400	3998 mm	1 Pz
LM5864P.600	6000 mm	1 Pz



COPERTINA PER BINARIO

Materiale: Alluminio

Finitura: /6 /88 /97

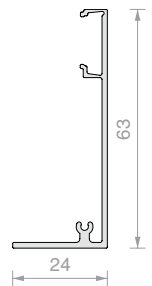

Art.	Lunghezza	Q.tà
LM0064CP.200	1998 mm	1 Pz
LM0064CP.300	2998 mm	1 Pz
LM0064CP.400	3998 mm	1 Pz
LM0064CP.600	6000 mm	1 Pz

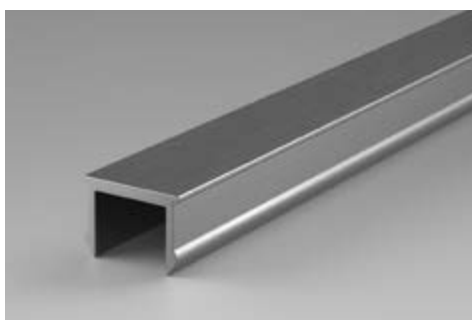

PROFILO DI FINITURA

Materiale: Alluminio

Finitura: /6 /88 /97

Art.	Lunghezza	Q.tà
LMC13.100	996 mm	1 Pz
LMC13.150	1498 mm	1 Pz
LMC13.200	1998 mm	1 Pz
LMC13.300	3000 mm	1 Pz

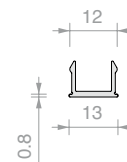

PROFILO A "U"

Materiale: Alluminio

Finitura: /6 /88 /91 /97

Art.	Lunghezza	Q.tà
LMU20.100	996 mm	1 Pz
LMU20.150	1498 mm	1 Pz
LMU20.300	3000 mm	1 Pz

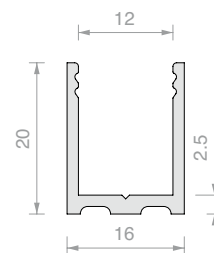

TAPPO DI FINITURA

Materiale: Alluminio

Finitura: /88 /91 /97 /R2

Art.	Q.tà
LMU20TP	1 Pz

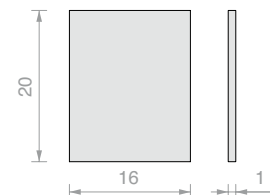

GUARNIZIONE FERMAVETRO

Materiale: PVC

Art.	Spessore	Colore	Q.tà	Art.	Spessore	Colore	Q.tà	Art.	Spessore	Colore	Q.tà
GTUP2	2 mm	Trasparente	1 m	GTUP2G	2 mm	Goffrata	1 m	GTUP2N	2 mm	Nera	1 m
GTUP3	3 mm	Trasparente	1 m	GTUP3G	3 mm	Goffrata	1 m	GTUP3N	3 mm	Nera	1 m
GTUP4	4 mm	Trasparente	1 m	GTUP4G	4 mm	Goffrata	1 m	GTUP4N	4 mm	Nera	1 m
GTUP5	5 mm	Trasparente	1 m	GTUP5G	5 mm	Goffrata	1 m	GTUP5N	5 mm	Nera	1 m
GTUP6	6 mm	Trasparente	1 m	GTUP6G	6 mm	Goffrata	1 m	GTUP6N	6 mm	Nera	1 m



TAPPO DI FINITURA 3 VITI

Materiale: Alluminio

Installazione sia lato DX che SX.

Finitura: /6 /88 /97

Art.	Q.tà
LM63061TP33	1 Pz

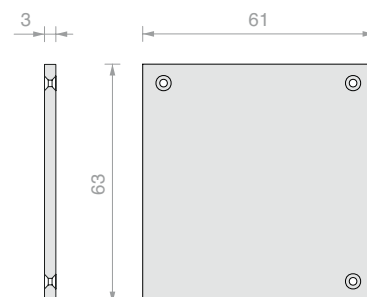



PINZA REGOLABILE CON RUOTA

Materiale: Alluminio e acciaio

Art.	Per Vetri	Q.tà
CERPOS162	Da 8 a 10.8 mm	1 Pz



STOP SENZA FERMO

Materiale: Zama

Art.	Q.tà
LMPS-STP55	1 Pz



GUIDA A TERRA

Materiale: Alluminio

Finitura: /88 /97 /R2

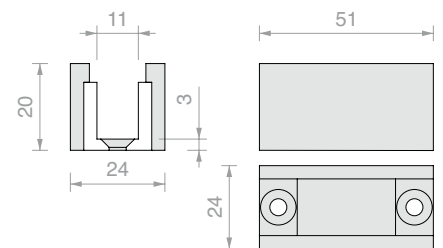

Art.	Per Vetri	Q.tà
LMGF	Da 8 a 10.8 mm	1 Pz



KIT COMPLETO AMMORTIZZATORE SOFTBREAK A DOPPIA AZIONE

Materiale: POM, Alluminio e Zama

Consente lo smorzamento in apertura e in chiusura

Kit completo di 1 ammortizzatore, 1 pinza di sostegno e 2 attivatori

Art.	Portata	Q.tà
LMDMP070ZKIT	Da 40 a 70 kg	1 Pz
LMDMP100ZKIT	Da 70 a 100 kg	1 Pz



AMMORTIZZATORE SOFTBREAK A DOPPIA AZIONE

Materiale: POM

Consente lo smorzamento in apertura e in chiusura

Per l'utilizzo dell'ammortizzatore è necessaria la presenza anche di una pinza di sostegno e di 1/2 attivatori in funzione del lato da ammortizzare

Art.	Portata	Q.tà
LMDMP070Z	Da 40 a 70 kg	1 Pz
LMDMP100Z	Da 70 a 100 kg	1 Pz



PINZA DI SOSTEGNO PER AMMORTIZZATORE

Materiale: Alluminio

Art.	Q.tà
LMPS-PSD62	1 Pz



ATTIVATORE PER AMMORTIZZATORE

Materiale: Zama

Art.	Q.tà
LMSIN-GA55	1 Pz



KIT DI SINCRONISMO

Art.	Q.tà
LMSIN-AC55	1 Pz

Forme

Profili in dimensioni ridotte per decorare le ante in vetro.
Applicazione sul vetro mediante biadesivo di spessore 0.5 mm, silicone o incollaggio UV.
Selezionare la guida e gli accessori adeguati per alloggiare il vetro e il suo profilo di bordatura.





PROFILO PIATTO SERIE FORME

Materiale: Alluminio
 Finitura: /6 /88 /97 /RAL

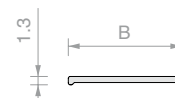

Art.	B	Lunghezza	Q.tà
FOP10.30	10 mm	3000 mm	1 Pz
FOP15.30	15 mm	3000 mm	1 Pz
FOP20.30	20 mm	3000 mm	1 Pz



PROFILO A "U" SERIE FORME

Materiale: Alluminio
 Finitura: /6 /88 /97 /RAL

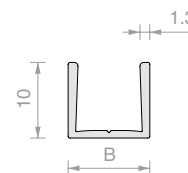

Art.	B	Lunghezza	Per vetri	Q.tà
FOU1011.30	10.8 mm	3000 mm	8 mm	1 Pz
FOU1013.30	12.8 mm	3000 mm	10 mm	1 Pz



BIADESIVO TESA® ACX^{plus}

Biadesivo trasparente per fissaggi di vetro, acciaio e alluminio.
 Il liner in carta agevola l'applicazione manuale del nastro.

Art.	Dimensioni	Spessore	Q.tà
TS250065	6 mm x 25 m	0.5 mm	1 Pz
TS250125	12 mm x 25 m	0.5 mm	1 Pz
TS250155	15 mm x 25 m	0.5 mm	1 Pz



GUIDA A PAVIMENTO

Materiale: Alluminio
 Finitura: /88 /97 /R2

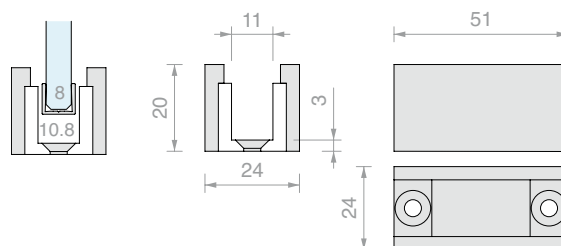

Art.	Per profilo	Q.tà
LMGF	FOU1011	1 Pz







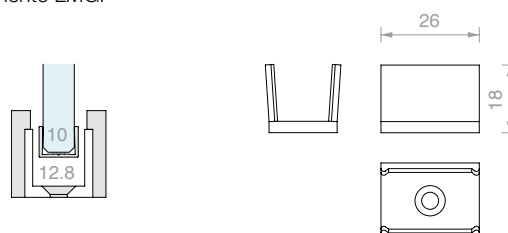

ADATTATORE PER GUIDA LMGF

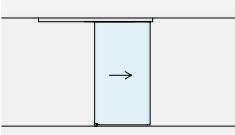
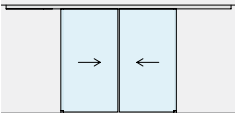
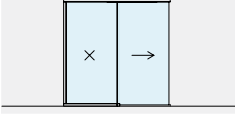
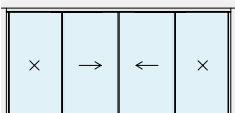
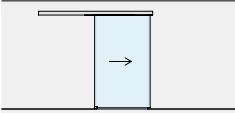
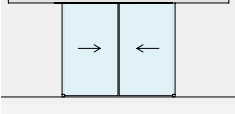

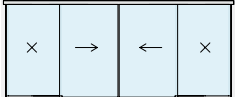



Accessorio da inserire nella guida a pavimento LMGF
 Materiale: plastica
 Finitura: /56

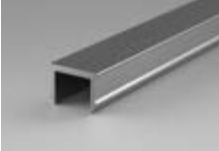



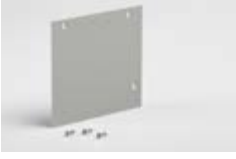







Art.	Per profilo	Q.tà
LMGF13-POM	FOU1013	1 Pz

Art.	Descrizione	Finitura	Q.tà	EURO
Kit scorrevole LM PORTA PRO				
	LMP6511P.200/6	Fissaggio a soffitto anta singola Lvmax 920	Nero opaco	1 Pz 533,70
	LMP6511P.200/88	Fissaggio a soffitto anta singola Lvmax 920	Alluminio simil-inox satin	1 Pz 526,16
	LMP6511P.200/97	Fissaggio a soffitto anta singola Lvmax 920	Alluminio opaco	1 Pz 509,22
	LMP6511P.300/6	Fissaggio a soffitto anta singola Lvmax 1420	Nero opaco	1 Pz 602,92
	LMP6511P.300/88	Fissaggio a soffitto anta singola Lvmax 1420	Alluminio simil-inox satin	1 Pz 594,24
	LMP6511P.300/97	Fissaggio a soffitto anta singola Lvmax 1420	Alluminio opaco	1 Pz 572,78
	LMP6511CP.400/6	Fissaggio a soffitto doppia anta sincronizzata Lvmax 1940	Nero opaco	1 Pz 1.092,98
	LMP6511CP.400/88	Fissaggio a soffitto doppia anta sincronizzata Lvmax 1940	Alluminio simil-inox satin	1 Pz 1.075,32
	LMP6511CP.400/97	Fissaggio a soffitto doppia anta sincronizzata Lvmax 1940	Alluminio opaco	1 Pz 1.051,74
	LMP6511FP.200/6	Fissaggio a soffitto anta singola e vetro fisso Lvmax 2000	Nero opaco	1 Pz 590,28
	LMP6511FP.200/88	Fissaggio a soffitto anta singola e vetro fisso Lvmax 2000	Alluminio simil-inox satin	1 Pz 554,58
	LMP6511FP.200/97	Fissaggio a soffitto anta singola e vetro fisso Lvmax 2000	Alluminio opaco	1 Pz 544,90
	LMP6511FP.300/6	Fissaggio a soffitto anta singola e vetro fisso Lvmax 3000	Nero opaco	1 Pz 695,34
	LMP6511FP.300/88	Fissaggio a soffitto anta singola e vetro fisso Lvmax 3000	Alluminio simil-inox satin	1 Pz 633,54
	LMP6511FP.300/97	Fissaggio a soffitto anta singola e vetro fisso Lvmax 3000	Alluminio opaco	1 Pz 617,42
	LMP6511CFP.400/6	Fissaggio a soffitto doppia anta sincronizzata e doppio vetro fisso Lvmax 4000	Nero opaco	1 Pz 1.195,22
	LMP6511CFP.400/88	Fissaggio a soffitto doppia anta sincronizzata e doppio vetro fisso Lvmax 4000	Alluminio simil-inox satin	1 Pz 1.123,84
	LMP6511CFP.400/97	Fissaggio a soffitto doppia anta sincronizzata e doppio vetro fisso Lvmax 4000	Alluminio opaco	1 Pz 1.104,46
	LMP6521P.200/6	Fissaggio a parete anta singola Lvmax 920	Nero opaco	1 Pz 533,70
	LMP6521P.200/88	Fissaggio a parete anta singola Lvmax 920	Alluminio simil-inox satin	1 Pz 526,16
	LMP6521P.200/97	Fissaggio a parete anta singola Lvmax 920	Alluminio opaco	1 Pz 509,22
	LMP6521P.300/6	Fissaggio a parete anta singola Lvmax 1420	Nero opaco	1 Pz 602,92
	LMP6521P.300/88	Fissaggio a parete anta singola Lvmax 1420	Alluminio simil-inox satin	1 Pz 594,24
	LMP6521P.300/97	Fissaggio a parete anta singola Lvmax 1420	Alluminio opaco	1 Pz 572,78
	LMP6521CP.400/6	Fissaggio a parete doppia anta sincronizzata Lvmax 1940	Nero opaco	1 Pz 1.092,98
	LMP6521CP.400/88	Fissaggio a parete doppia anta sincronizzata Lvmax 1940	Alluminio simil-inox satin	1 Pz 1.075,32
	LMP6521CP.400/97	Fissaggio a parete doppia anta sincronizzata Lvmax 1940	Alluminio opaco	1 Pz 1.051,74
	LMP6521FP.200/6	Fissaggio a parete anta singola e vetro fisso Lvmax 1880	Nero opaco	1 Pz 617,90
	LMP6521FP.200/88	Fissaggio a parete anta singola e vetro fisso Lvmax 1880	Alluminio simil-inox satin	1 Pz 584,78
	LMP6521FP.200/97	Fissaggio a parete anta singola e vetro fisso Lvmax 1880	Alluminio opaco	1 Pz 564,80
	LMP6521FP.300/6	Fissaggio a parete anta singola e vetro fisso Lvmax 2880	Nero opaco	1 Pz 722,96
	LMP6521FP.300/88	Fissaggio a parete anta singola e vetro fisso Lvmax 2880	Alluminio simil-inox satin	1 Pz 663,74
	LMP6521FP.300/97	Fissaggio a parete anta singola e vetro fisso Lvmax 2880	Alluminio opaco	1 Pz 637,34
	LMP6521CFP.400/6	Fissaggio a parete doppia anta sincronizzata e doppio vetro fisso Lvmax 3880	Nero opaco	1 Pz 1.222,84
	LMP6521CFP.400/88	Fissaggio a parete doppia anta sincronizzata e doppio vetro fisso Lvmax 3880	Alluminio simil-inox satin	1 Pz 1.154,04
	LMP6521CFP.400/97	Fissaggio a parete doppia anta sincronizzata e doppio vetro fisso Lvmax 3880	Alluminio opaco	1 Pz 1.124,36

	Art.	Descrizione	Finitura	Q.tà	EURO
	LM5864S.200/6	Binario fissaggio a soffitto, B55 H64 L1998	Nero opaco	1 Pz	152,36
	LM5864S.200/88	Binario fissaggio a soffitto, B55 H64 L1998	Alluminio simil-inox satin	1 Pz	150,20
	LM5864S.200/97	Binario fissaggio a soffitto, B55 H64 L1998	Alluminio opaco	1 Pz	141,58
	LM5864S.300/6	Binario fissaggio a soffitto, B55 H64 L2998	Nero opaco	1 Pz	220,12
	LM5864S.300/88	Binario fissaggio a soffitto, B55 H64 L2998	Alluminio simil-inox satin	1 Pz	216,88
	LM5864S.300/97	Binario fissaggio a soffitto, B55 H64 L2998	Alluminio opaco	1 Pz	203,96
	LM5864S.400/6	Binario fissaggio a soffitto, B55 H64 L3998	Nero opaco	1 Pz	287,88
	LM5864S.400/88	Binario fissaggio a soffitto, B55 H64 L3998	Alluminio simil-inox satin	1 Pz	283,56
	LM5864S.400/97	Binario fissaggio a soffitto, B55 H64 L3998	Alluminio opaco	1 Pz	266,36
	LM5864S.600/6	Binario fissaggio a soffitto, B55 H64 L6000	Nero opaco	1 Pz	408,00
	LM5864S.600/88	Binario fissaggio a soffitto, B55 H64 L6000	Alluminio simil-inox satin	1 Pz	401,52
	LM5864S.600/97	Binario fissaggio a soffitto, B55 H64 L6000	Alluminio opaco	1 Pz	375,70
	LM5864P.200/6	Binario fissaggio a parete, B55 H64 L1998	Nero opaco	1 Pz	152,36
	LM5864P.200/88	Binario fissaggio a parete, B55 H64 L1998	Alluminio simil-inox satin	1 Pz	150,20
	LM5864P.200/97	Binario fissaggio a parete, B55 H64 L1998	Alluminio opaco	1 Pz	141,58
	LM5864P.300/6	Binario fissaggio a parete, B55 H64 L2998	Nero opaco	1 Pz	220,12
	LM5864P.300/88	Binario fissaggio a parete, B55 H64 L2998	Alluminio simil-inox satin	1 Pz	216,88
	LM5864P.300/97	Binario fissaggio a parete, B55 H64 L2998	Alluminio opaco	1 Pz	203,96
	LM5864P.400/6	Binario fissaggio a parete, B55 H64 L3998	Nero opaco	1 Pz	287,88
	LM5864P.400/88	Binario fissaggio a parete, B55 H64 L3998	Alluminio simil-inox satin	1 Pz	283,56
	LM5864P.400/97	Binario fissaggio a parete, B55 H64 L3998	Alluminio opaco	1 Pz	266,36
	LM5864P.600/6	Binario fissaggio a parete, B55 H64 L6000	Nero opaco	1 Pz	408,00
	LM5864P.600/88	Binario fissaggio a parete, B55 H64 L6000	Alluminio simil-inox satin	1 Pz	401,52
	LM5864P.600/97	Binario fissaggio a parete, B55 H64 L6000	Alluminio opaco	1 Pz	375,70
	LM0064CP.200/6	Copertina per binario, B25.7 H63 L1998	Nero opaco	1 Pz	47,40
	LM0064CP.200/88	Copertina per binario, B25.7 H63 L1998	Alluminio simil-inox satin	1 Pz	46,84
	LM0064CP.200/97	Copertina per binario, B25.7 H63 L1998	Alluminio opaco	1 Pz	44,60
	LM0064CP.300/6	Copertina per binario, B25.7 H63 L2998	Nero opaco	1 Pz	62,70
	LM0064CP.300/88	Copertina per binario, B25.7 H63 L2998	Alluminio simil-inox satin	1 Pz	61,84
	LM0064CP.300/97	Copertina per binario, B25.7 H63 L2998	Alluminio opaco	1 Pz	58,48
	LM0064CP.400/6	Copertina per binario, B25.7 H63 L3998	Nero opaco	1 Pz	77,98
	LM0064CP.400/88	Copertina per binario, B25.7 H63 L3998	Alluminio simil-inox satin	1 Pz	76,86
	LM0064CP.400/97	Copertina per binario, B25.7 H63 L3998	Alluminio opaco	1 Pz	72,38
	LM0064CP.600/6	Copertina per binario, B25.7 H63 L6000	Nero opaco	1 Pz	93,14
	LM0064CP.600/88	Copertina per binario, B25.7 H63 L6000	Alluminio simil-inox satin	1 Pz	91,46
	LM0064CP.600/97	Copertina per binario, B25.7 H63 L6000	Alluminio opaco	1 Pz	84,74
	LMC13.100/6	Profilo di finitura, L996	Nero opaco	1 Pz	13,52
	LMC13.100/88	Profilo di finitura, L996	Alluminio simil-inox satin	1 Pz	13,14
	LMC13.100/97	Profilo di finitura, L996	Alluminio opaco	1 Pz	12,78
	LMC13.150/6	Profilo di finitura, L1498	Nero opaco	1 Pz	16,64
	LMC13.150/88	Profilo di finitura, L1498	Alluminio simil-inox satin	1 Pz	16,08
	LMC13.150/97	Profilo di finitura, L1498	Alluminio opaco	1 Pz	15,54
	LMC13.200/6	Profilo di finitura, L1998	Nero opaco	1 Pz	17,44
	LMC13.200/88	Profilo di finitura, L1998	Alluminio simil-inox satin	1 Pz	16,76
	LMC13.200/97	Profilo di finitura, L1998	Alluminio opaco	1 Pz	16,14
	LMC13.300/6	Profilo di finitura, L3000	Nero opaco	1 Pz	18,44

Art.	Descrizione	Finitura	Q.tà	EURO	
LMC13.300/88	Profilo di finitura, L3000	Alluminio simil-inox satin	1 Pz	17,32	
LMC13.300/97	Profilo di finitura, L3000	Alluminio opaco	1 Pz	16,32	
	LMU20.100/6	Profilo a "U", B16 H20 L996	Nero opaco	1 Pz	32,14
	LMU20.100/88	Profilo a "U", B16 H20 L996	Alluminio simil-inox satin	1 Pz	28,20
	LMU20.100/91	Profilo a "U", B16 H20 L996	Alluminio lucido	1 Pz	29,86
	LMU20.100/97	Profilo a "U", B16 H20 L996	Alluminio opaco	1 Pz	26,80
	LMU20.150/6	Profilo a "U", B16 H20 L1498	Nero opaco	1 Pz	44,00
	LMU20.150/88	Profilo a "U", B16 H20 L1498	Alluminio simil-inox satin	1 Pz	34,94
	LMU20.150/91	Profilo a "U", B16 H20 L1498	Alluminio lucido	1 Pz	36,54
	LMU20.150/97	Profilo a "U", B16 H20 L1498	Alluminio opaco	1 Pz	32,86
	LMU20.300/6	Profilo a "U", B16 H20 L3000	Nero opaco	1 Pz	64,80
	LMU20.300/88	Profilo a "U", B16 H20 L3000	Alluminio simil-inox satin	1 Pz	50,96
	LMU20.300/91	Profilo a "U", B16 H20 L3000	Alluminio lucido	1 Pz	54,00
	LMU20.300/97	Profilo a "U", B16 H20 L3000	Alluminio opaco	1 Pz	46,90
	LMU20TP/88	Tappo di finitura, B16 H20 L1	Alluminio simil-inox satin	1 Pz	5,78
	LMU20TP/91	Tappo di finitura, B16 H20 L1	Alluminio lucido	1 Pz	5,78
	LMU20TP/97	Tappo di finitura, B16 H20 L1	Alluminio opaco	1 Pz	5,68
	LMU20TP/R2	Tappo di finitura, B16 H20 L1	RAL9005 Nero opaco	1 Pz	7,00
	GTUP2	Guarnizione fermavetro, H2	Trasparente	1 m	1,10
	GTUP3	Guarnizione fermavetro, H3	Trasparente	1 m	1,26
	GTUP4	Guarnizione fermavetro, H4	Trasparente	1 m	1,54
	GTUP5	Guarnizione fermavetro, H5	Trasparente	1 m	2,14
	GTUP6	Guarnizione fermavetro, H6	Trasparente	1 m	3,00
	GTUP2G	Guarnizione fermavetro, H2	Goffrato	1 m	1,64
	GTUP3G	Guarnizione fermavetro, H3	Goffrato	1 m	1,84
	GTUP4G	Guarnizione fermavetro, H4	Goffrato	1 m	2,08
	GTUP5G	Guarnizione fermavetro, H5	Goffrato	1 m	2,36
	GTUP6G	Guarnizione fermavetro, H6	Goffrato	1 m	3,46
	GTUP2N	Guarnizione fermavetro, H2	Nero	1 m	1,10
	GTUP3N	Guarnizione fermavetro, H3	Nero	1 m	1,26
	GTUP4N	Guarnizione fermavetro, H4	Nero	1 m	1,54
	GTUP5N	Guarnizione fermavetro, H5	Nero	1 m	2,14
	GTUP6N	Guarnizione fermavetro, H6	Nero	1 m	3,00
	LM63061TP33/6	Tappo di finitura con 3 viti, B61 H63	Nero opaco	1 Pz	22,44
	LM63061TP33/88	Tappo di finitura con 3 viti, B61 H63	Alluminio simil-inox satin	1 Pz	22,44
	LM63061TP33/97	Tappo di finitura con 3 viti, B61 H63	Alluminio opaco	1 Pz	21,06
	CERPOS162	Pinza per scorrevoli regolabile con ruota, per vetri 8/10.8		1 Pz	133,40
	LMPS-STP55	Stop senza fermo		1 Pz	17,12
	LMGF/88	Guida a terra, per vetri 8/10.8, B25 H23 L46	Alluminio simil-inox satin	1 Pz	23,92
	LMGF/97	Guida a terra, per vetri 8/10.8, B25 H23 L46	Alluminio opaco	1 Pz	23,92
	LMGF/R2	Guida a terra, per vetri 8/10.8, B25 H23 L46	RAL9005 Nero opaco	1 Pz	28,72

	Art.	Descrizione	Finitura	Q.tà	EURO
	LMDMP070ZKIT	Kit completo ammortizzatore softbreak a doppia azione da 40 a 70 kg		1 Pz	110,62
	LMDMP100ZKIT	Kit completo ammortizzatore softbreak a doppia azione da 70 a 100 kg		1 Pz	110,62
	LMDMP070Z	Ammortizzatore softbreak a doppia azione da 40 a 70 kg		1 Pz	61,40
	LMDMP100Z	Ammortizzatore softbreak a doppia azione da 70 a 100 kg		1 Pz	61,40
	LMPS-PSD62	Pinza di sostegno per ammortizzatore		1 Pz	19,26
	LMSIN-GA55	Attivatore per ammortizzatore		1 Pz	14,98
	LMSIN-AC55	Kit di sincronismo		1 Pz	121,40
	FOP10.30/6	Profilo piatto serie FORME, B10 H1.3 L3000	Nero opaco	1 Pz	30,29
	FOP10.30/88	Profilo piatto serie FORME, B10 H1.3 L3000	Alluminio simil-inox satin	1 Pz	30,29
	FOP10.30/97	Profilo piatto serie FORME, B10 H1.3 L3000	Alluminio opaco	1 Pz	22,73
	FOP10.30/RAL	Profilo piatto serie FORME, B10 H1.3 L3000	RAL9010 Bianco lucido	1 Pz	26,51
	FOP15.30/6	Profilo piatto serie FORME, B15 H1.3 L3000	Nero opaco	1 Pz	32,12
	FOP15.30/88	Profilo piatto serie FORME, B15 H1.3 L3000	Alluminio simil-inox satin	1 Pz	32,12
	FOP15.30/97	Profilo piatto serie FORME, B15 H1.3 L3000	Alluminio opaco	1 Pz	24,56
	FOP15.30/RAL	Profilo piatto serie FORME, B15 H1.3 L3000	RAL9010 Bianco lucido	1 Pz	28,34
	FOP20.30/6	Profilo piatto serie FORME, B20 H1.3 L3000	Nero opaco	1 Pz	34,53
	FOP20.30/88	Profilo piatto serie FORME, B20 H1.3 L3000	Alluminio simil-inox satin	1 Pz	34,53
	FOP20.30/97	Profilo piatto serie FORME, B20 H1.3 L3000	Alluminio opaco	1 Pz	26,97
	FOP20.30/RAL	Profilo piatto serie FORME, B20 H1.3 L3000	RAL9010 Bianco lucido	1 Pz	30,75
	FOU1011.30/6	Profilo piatto a "U" serie FORME, per vetri 8, B10.8 H10 L3000	Nero opaco	1 Pz	42,94
	FOU1011.30/88	Profilo piatto a "U" serie FORME, per vetri 8, B10.8 H10 L3000	Alluminio simil-inox satin	1 Pz	42,94
	FOU1011.30/97	Profilo piatto a "U" serie FORME, per vetri 8, B10.8 H10 L3000	Alluminio opaco	1 Pz	35,38
	FOU1011.30/RAL	Profilo piatto a "U" serie FORME, per vetri 8, B10.8 H10 L3000	RAL9010 Bianco lucido	1 Pz	39,16
	FOU1013.30/6	Profilo piatto a "U" serie FORME, per vetri 10, B12.8 H10 L3000	Nero opaco	1 Pz	45,48
	FOU1013.30/88	Profilo piatto a "U" serie FORME, per vetri 10, B12.8 H10 L3000	Alluminio simil-inox satin	1 Pz	45,48
	FOU1013.30/97	Profilo piatto a "U" serie FORME, per vetri 10, B12.8 H10 L3000	Alluminio opaco	1 Pz	37,92
	FOU1013.30/RAL	Profilo piatto a "U" serie FORME, per vetri 10, B12.8 H10 L3000	RAL9010 Bianco lucido	1 Pz	41,70
	TS250065	Biadesivo Tesa® ACXplus, B6 H0.5 L25m	Trasparente	1 Pz	30,24
	TS250125	Biadesivo Tesa® ACXplus, B12 H0.5 L25m	Trasparente	1 Pz	60,48
	TS250155	Biadesivo Tesa® ACXplus, B15 H0.5 L25m	Trasparente	1 Pz	95,90
	LMGF/88	Guida a terra, per vetri 8/10.8, B25 H23 L46	Alluminio simil-inox satin	1 Pz	23,92
	LMGF/97	Guida a terra, per vetri 8/10.8, B25 H23 L46	Alluminio opaco	1 Pz	23,92
	LMGF/R2	Guida a terra, per vetri 8/10.8, B25 H23 L46	RAL9005 Nero opaco	1 Pz	28,72
	LMGF-13-POM/56	Adattatore per guida LMGF	Grigio	1 Pz	6,90



Saint-Gobain Logli S.r.l.
Via Chemnitz, 49/51
59100 Prato - Italia
www.sg-logli.it

