

 **logli**
SAINT-GOBAIN

NEU
LM PORTA PRO

Essenziell, entwickelt,
erstaunlich.



SAINT-GOBAIN

LM PORTA PRO

NEUHEIT
2025

Design

Essenziell, entwickelt, erstaunlich.

LM PORTA PRO ist ein Schiebesystem, **das klares Design, Designvielfalt und hohe technische Leistung vereint.**

Reine Linien, harmonische Proportionen und optimierte Profile integrieren perfekt in jede Umgebung und schaffen eine elegante und zeitgemäße Lösung.

Das Herzstück des Systems, **eine kompakte 62 x 64 mm Schiene** und eine **neue Klemme, die vollständig aus Aluminium besteht**, ist auf Zuverlässigkeit und Langlebigkeit ausgelegt. Das Ergebnis?

Eine geprüfte Leistung von bis zu 45.000 Öffnungs- und Schließzyklen, für intensiven und stets reibungslosen Gebrauch.

Die LM PORTA Identität bleibt gut erkennbar:

- Wand- oder Decke Einbau
- Gestaltung mit oder ohne Fixglaswand,
- Ein einziger Dämpfer für den Türflügel der, sowohl beim Öffnen als auch beim Schließen mit einer fließenden und saften Bewegung, arbeitet.

LM PORTA PRO

Das komplette System mit langer Lebensdauer.

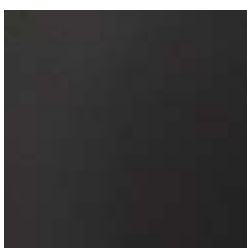
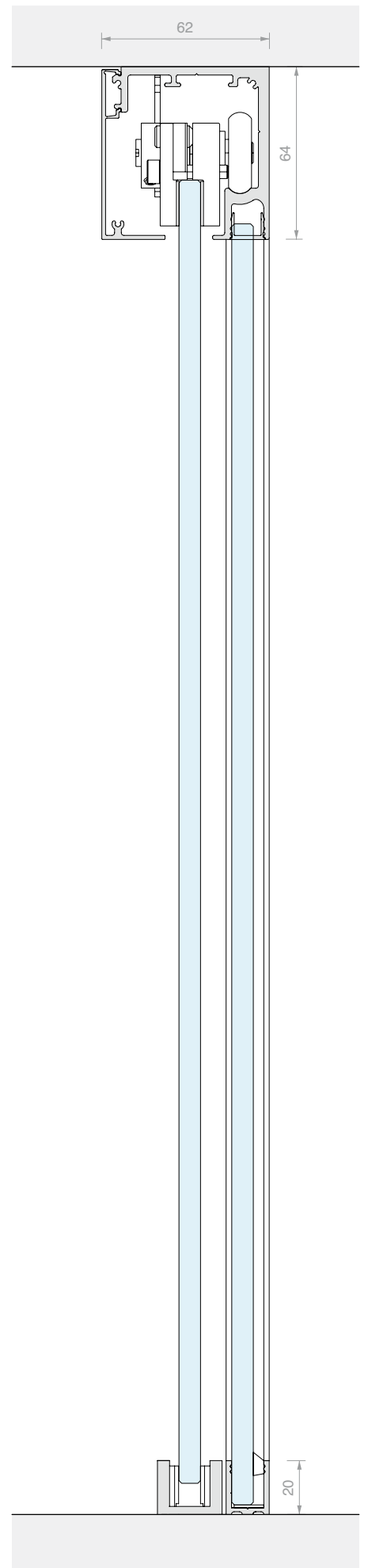

/6
Mattschwarz



/88
Aluminium Edelmetalloptik
satiniert



/97
Aluminium matt

Geprüft nach UNI EN 1527

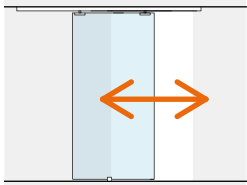

Türen von 100 kg
über **45.000 Zyklen**

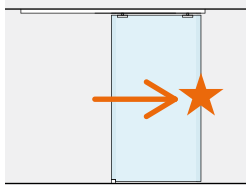

Zuschlagtest
KLASSE 3
(Höchstnote)

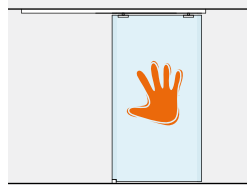

Horizontale
Belastung **KLASSE 3**
(Höchstnote)

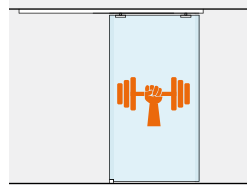

Besteht
Überlasttest
über **200 kg**

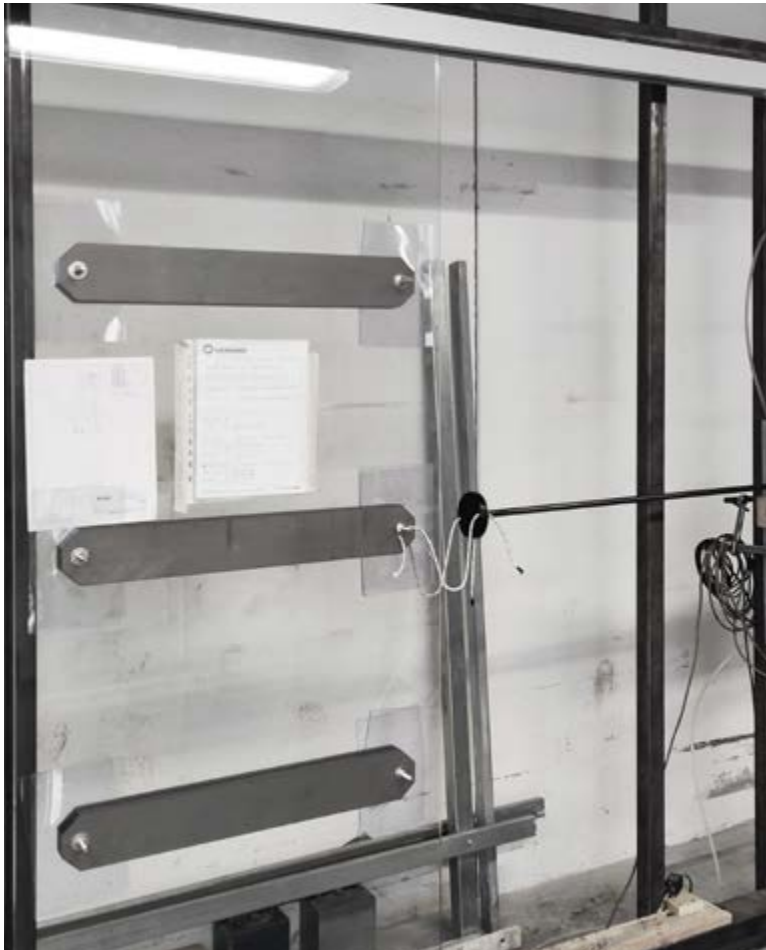

Eine geprüfte Leistung von bis zu 45.000 Öffnungs- und Schließzyklen



Überlasttest



Klemme die vollständig aus Aluminium besteht

LM PORTA PRO

NEUHEIT
2025

Technische Merkmale

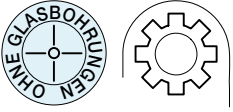

GLASTÜRFLÜGEL



▶ ◀ 8 - 10.8 mm

GLASWAND

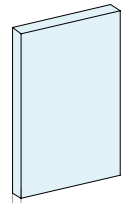

▶ ◀ 8 - 10.8 mm

2 Installationsarten

Decke

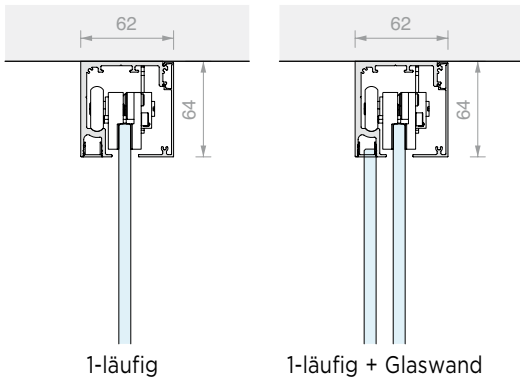

1-läufig

1-läufig + Glaswand

Wand

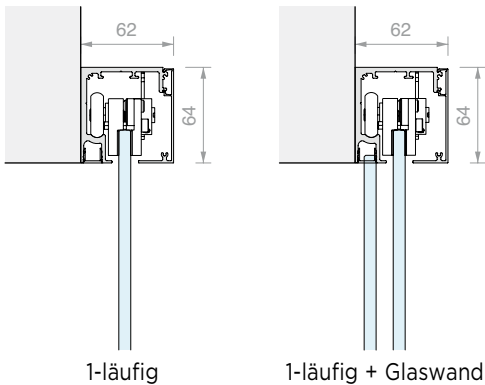

1-läufig

1-läufig + Glaswand

Blende h = 63mm



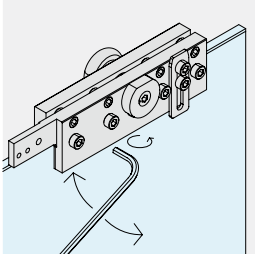
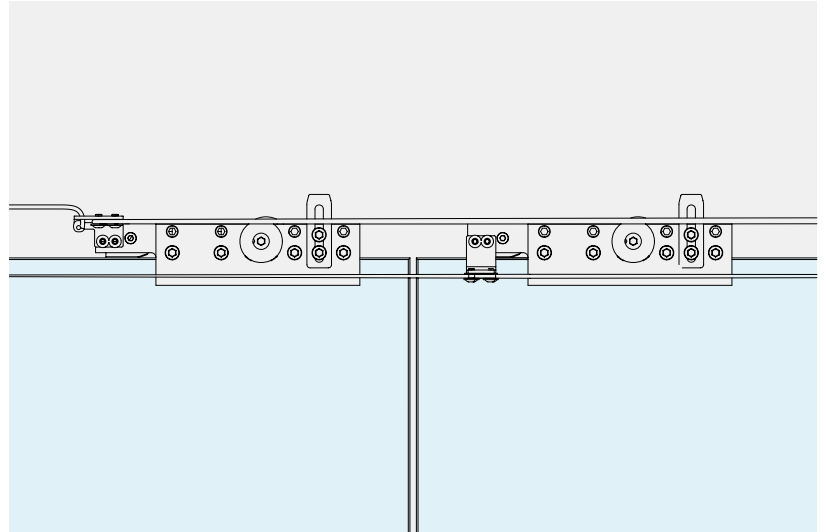
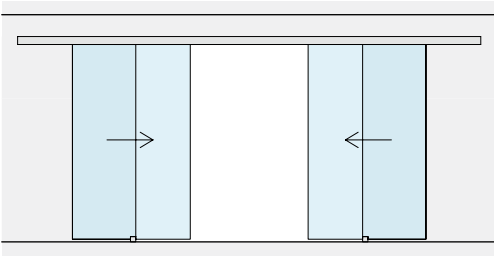

EINSTELLUNG TÜRFLÜGEL

Die Höhe der einzelnen Laufrollenwagen kann reguliert werden, um die Position des Türflügels um ± 3 mm einzustellen.

SYNCHRONLAUF

Zubehör für den Synchronlauf von zwei gegenüberliegenden beweglichen Türflügeln erhältlich.

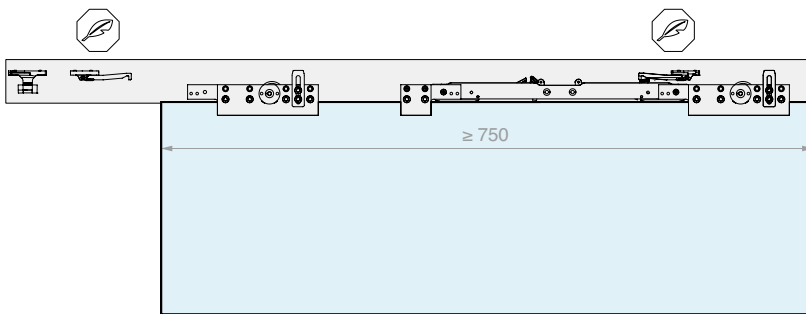

SOFT CLOSE

Die Verwendung eines einzigen Dämpfers ermöglicht ein kontrolliertes, sanftes Öffnen und Schließen.

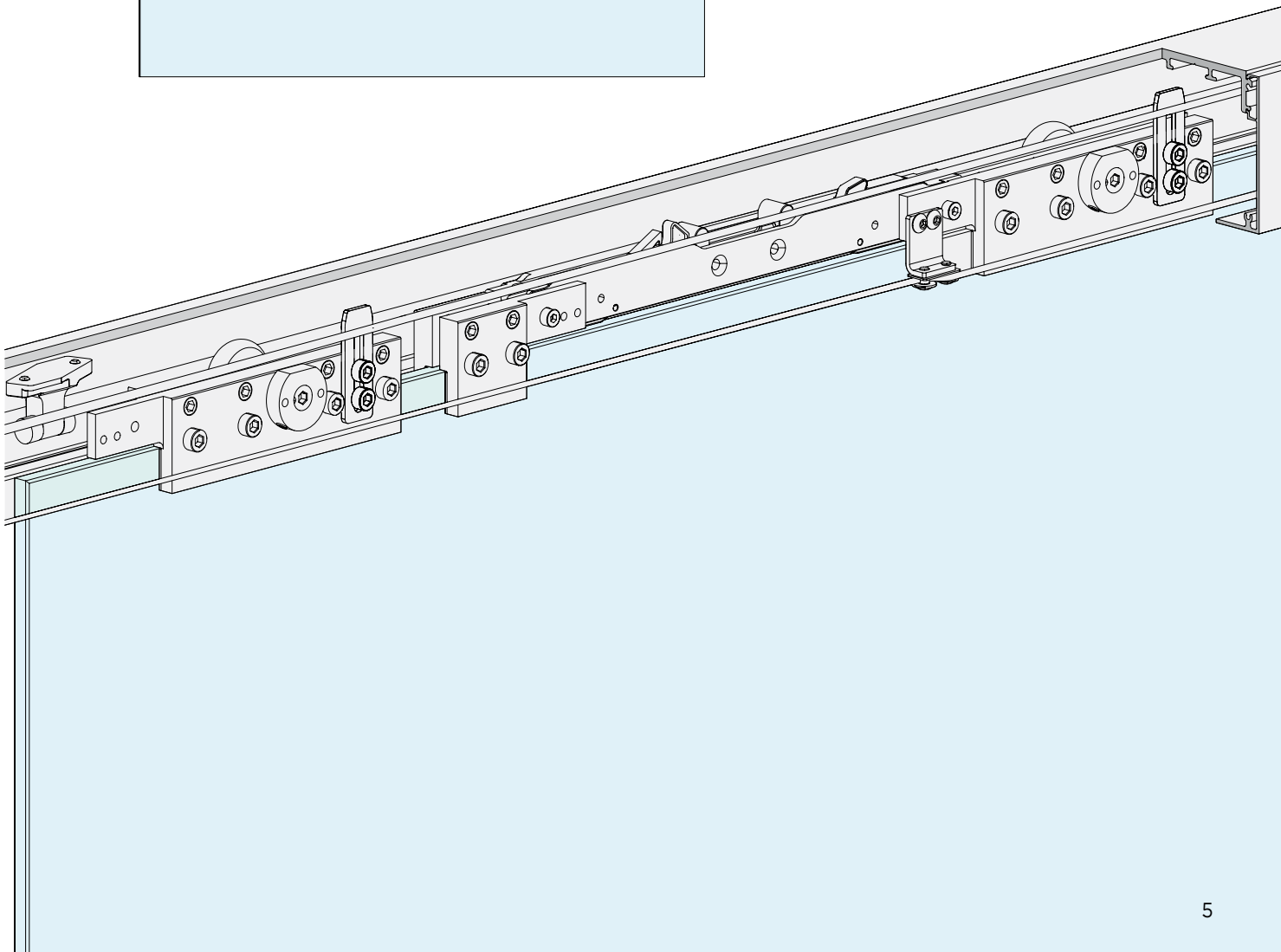



LM PORTA PRO

Set

DECKENMONTAGE

BEWEGLICHE TÜRFLÜGEL

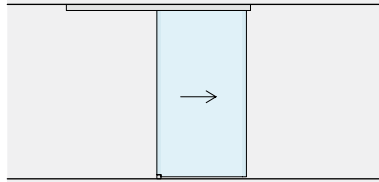

S. 8

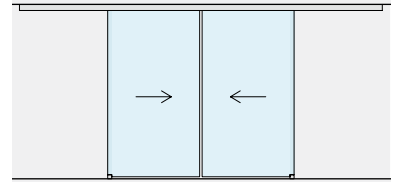

S. 12

BEWEGLICHE TÜRFLÜGEL
MIT GLASWAND

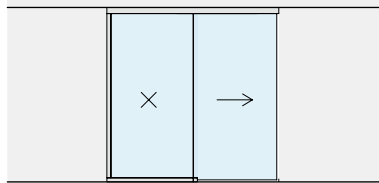

S. 16

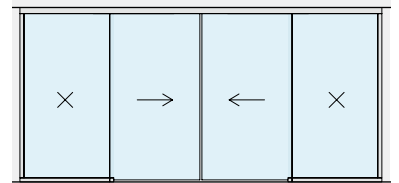

S. 20

WANDMONTAGE

BEWEGLICHE TÜRFLÜGEL

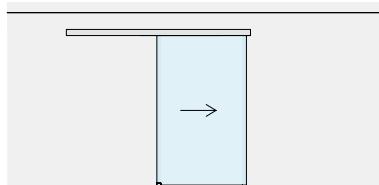

S. 24

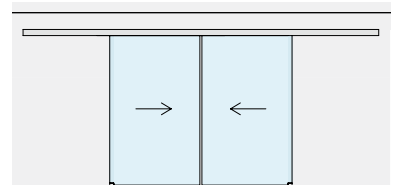

S. 26

BEWEGLICHE TÜRFLÜGEL
MIT GLASWAND

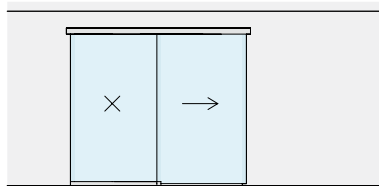

S. 30

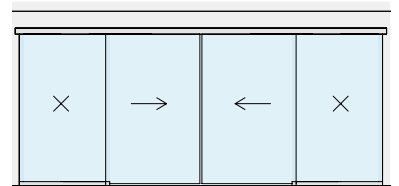

S. 32



SCHIEBETÜR-SET, DECKENBEFESTIGUNG, EINFLÜGELIG

Material: Aluminium

Oberfläche: /6 /88 /97



NEUHEIT 2025

WANDÖFFNUNGSMASS

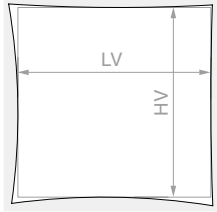

HV max.: 3000 mm

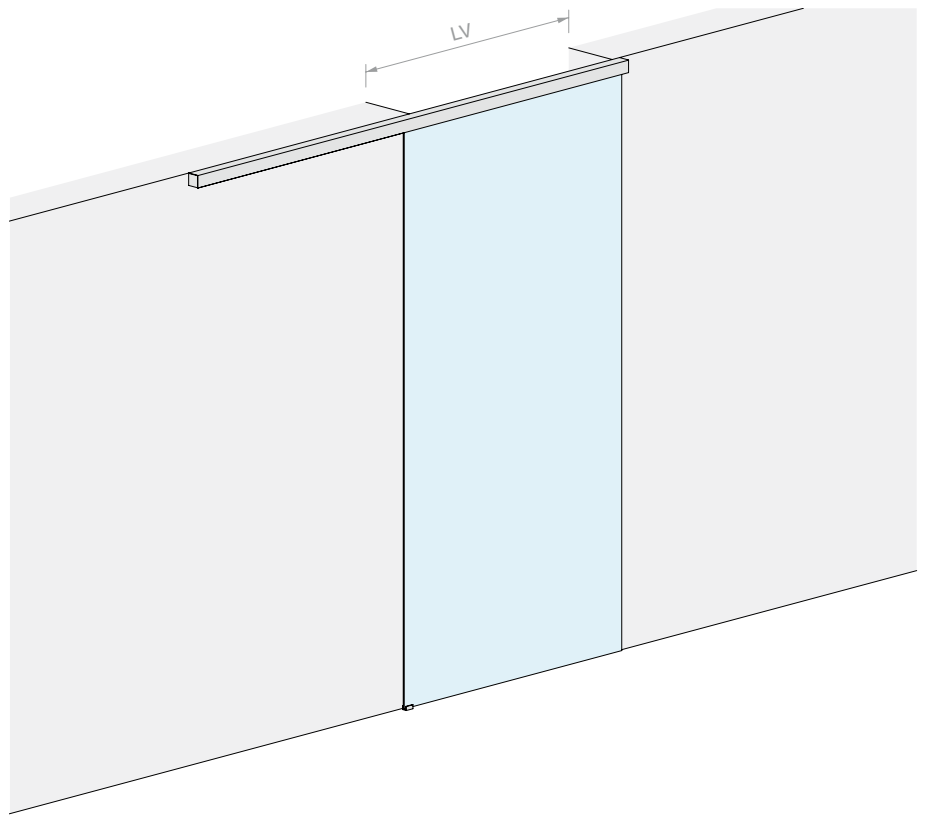

GLASTÜRFLÜGEL

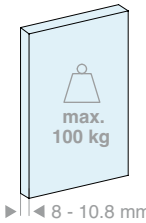

GLASTÜRFLÜGEL

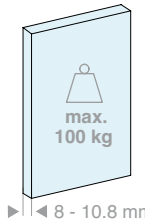

Set bestehend aus:

Art.	Beschreibung	Menge
LM5864S.200	Schiene Deckenbefestigung	1 Stk.
LM0064CP.200	Laufschienenblende	1 Stk.
LMC13.200	Abschlussprofil	1 Stk.
LM63061TP33	Endkappe	2 Stk.
CERPOS162	Klemme	2 Stk.
LMPS-STP55	Stopper ohne Feststeller	2 Stk.
LMGF	Bodenführung	1 Stk.

Optional

LMDMP070ZKIT	Doppelt wirkender Dämpfer Set von 40 bis 70 kg	1 Stk.
LMDMP100ZKIT	Doppelt wirkender Dämpfer Set von 70 bis 100 kg	1 Stk.

Set bestehend aus:

Art.	Beschreibung	Menge
LM5864S.300	Schiene Deckenbefestigung	1 Stk.
LM0064CP.300	Laufschienenblende	1 Stk.
LMC13.300	Abschlussprofil	1 Stk.
LM63061TP33	Endkappe	2 Stk.
CERPOS162	Klemme	2 Stk.
LMPS-STP55	Stopper ohne Feststeller	2 Stk.
LMGF	Bodenführung	1 Stk.

Optional

LMDMP070ZKIT	Doppelt wirkender Dämpfer Set von 40 bis 70 kg	1 Stk.
LMDMP100ZKIT	Doppelt wirkender Dämpfer Set von 70 bis 100 kg	1 Stk.

Art.	LV max.	Menge
LMP6511P.200	920 mm	1 Stk.

Art.	LV max.	Menge
LMP6511P.300	1420 mm	1 Stk.

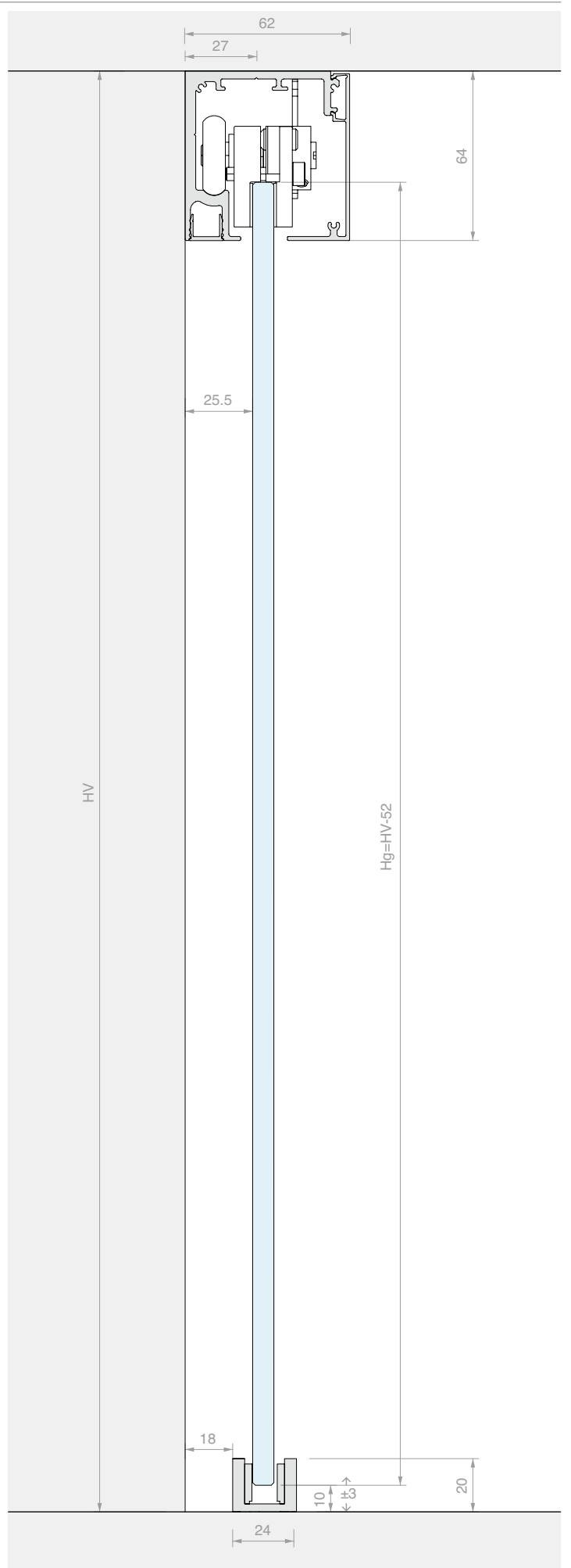
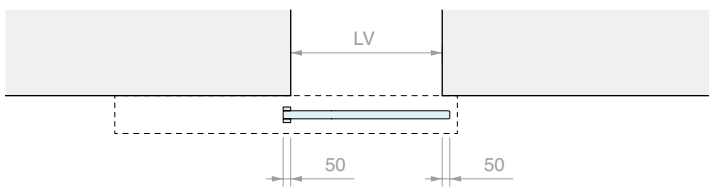
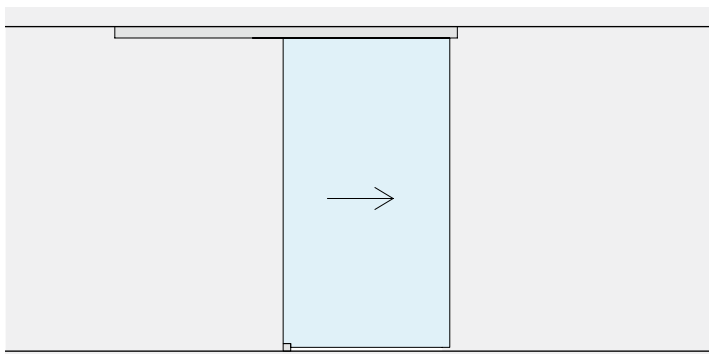
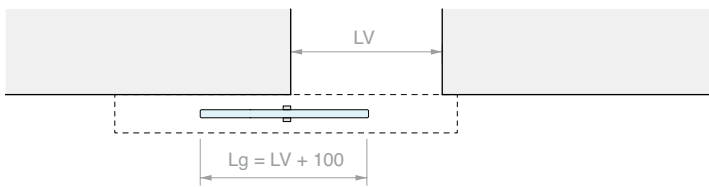
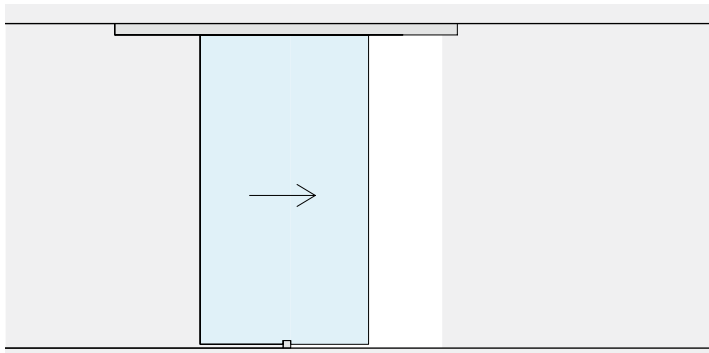
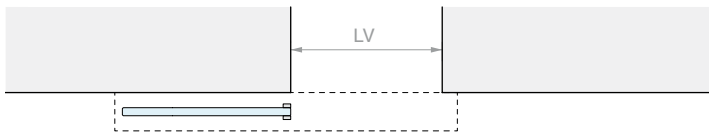
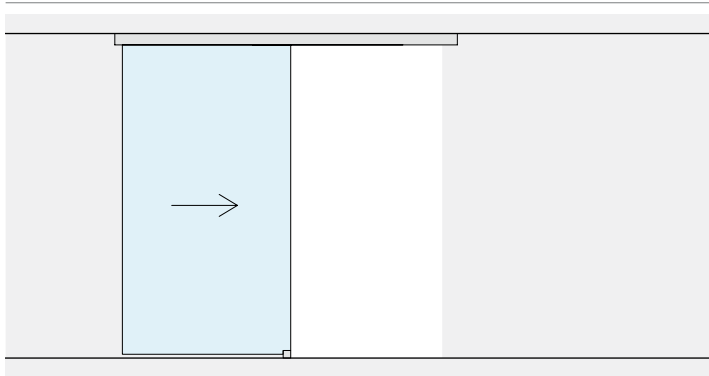





**SCHIEBETÜR-SET, DECKENBEFESTIGUNG,
ZWEI SYNCHRON LAUFENDE TÜRFLÜGEL**

Material: Aluminium

Oberfläche: /6 /88 /97

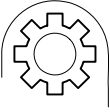
**NEUHEIT
2025**

WANDÖFFNUNGSMASS

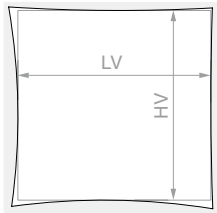

HV max.: 3000 mm

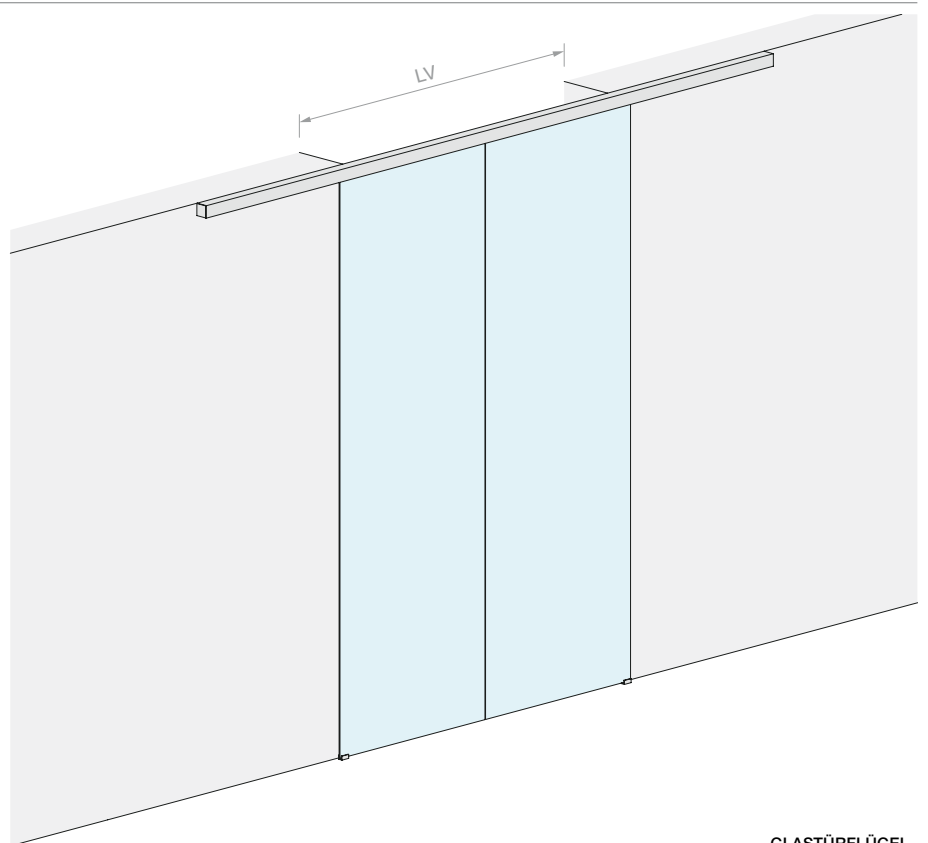

GLASTÜRFLÜGEL

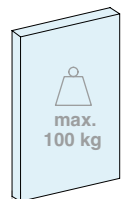

▶ | ◀ 8 - 10.8 mm

Set bestehend aus:

Art.	Beschreibung	Menge
LM5864S.400	Schiene Deckenbefestigung	1 Stk.
LM0064CP.400	Laufschienenblende	1 Stk.
LMC13.200	Abschlussprofil	2 Stk.
LM63061TP33	Endkappe	2 Stk.
CERPOS162	Klemme	4 Stk.
LMPS-STP55	Stopper ohne Feststeller	4 Stk.
LMGF	Bodenführung	2 Stk.
LMSIN-AC55	Synchronlauf-Set	1 Stk.
Optional		
LMDMP100ZKIT	Doppelt wirkender Dämpfer Set von 35 bis 50 kg	1 Stk.

Art.	LV max.	Menge
LMP6511CP.400	1940 mm	1 Stk.

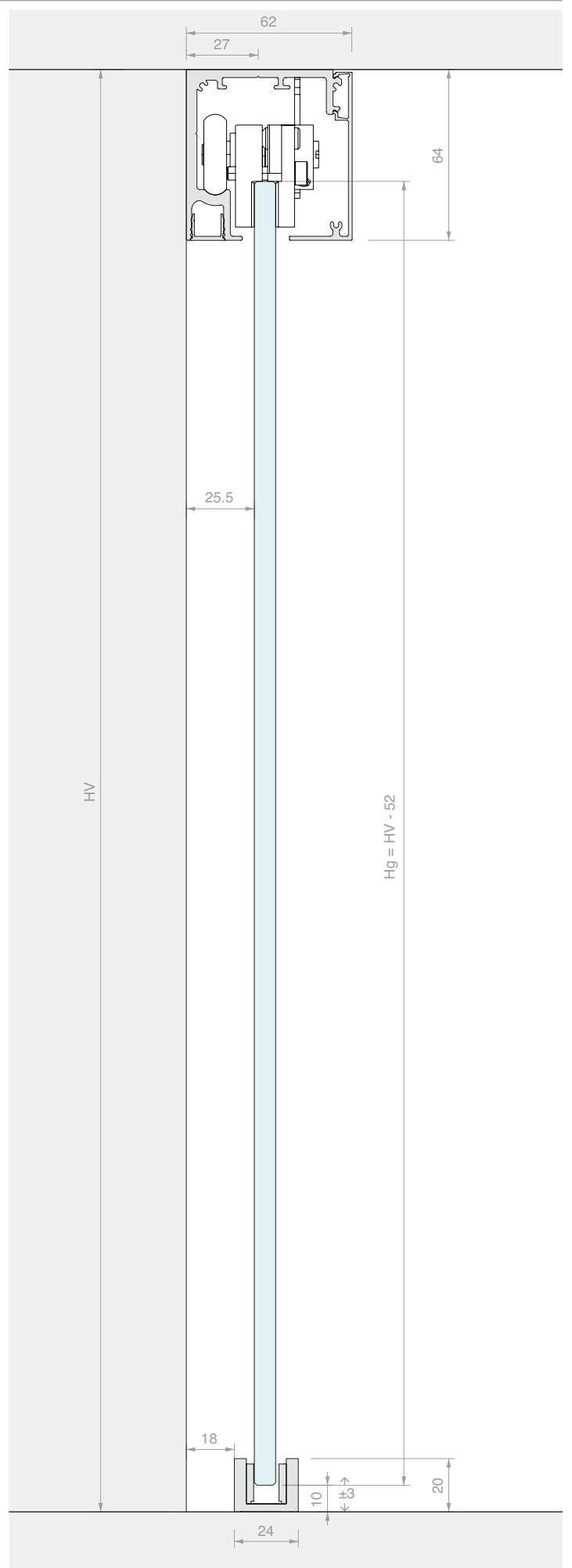
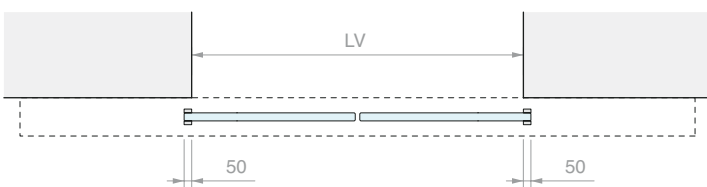
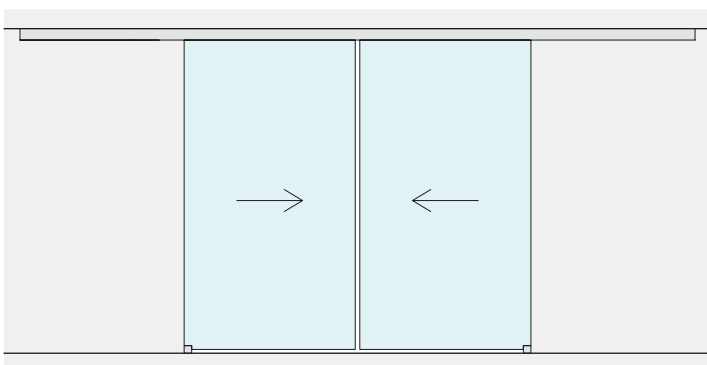
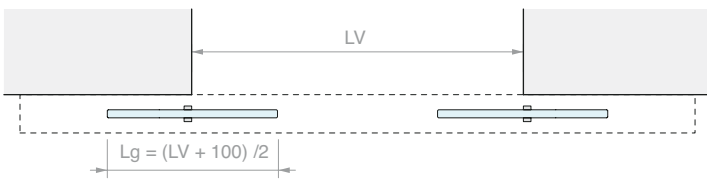
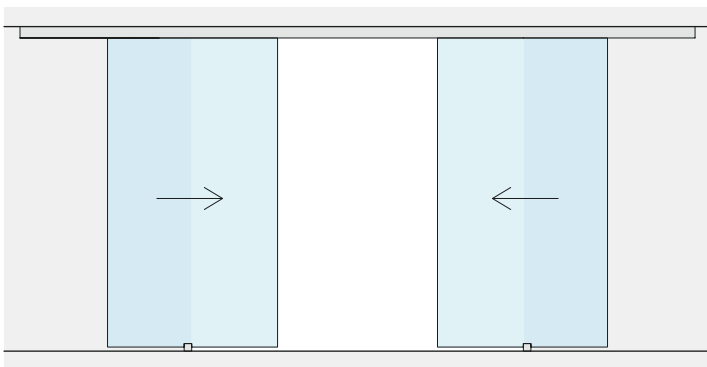
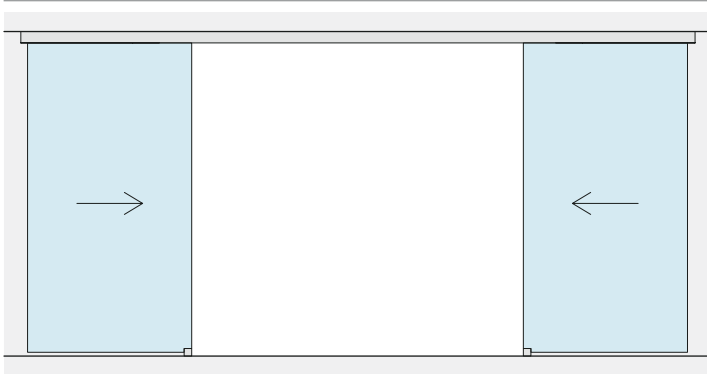





**SCHIEBETÜR-SET, DECKENBEFESTIGUNG, EINFLÜGELIG UND GLASWAND**

Material: Aluminium

Oberfläche: /6 /88 /97

**NEUHEIT 2025**

WANDÖFFNUNGSMASS

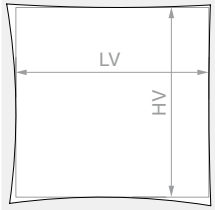

HV max.: 3000 mm

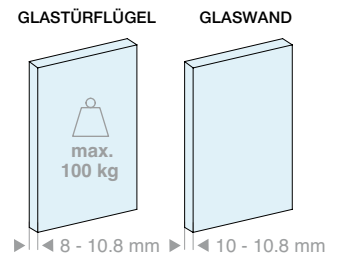
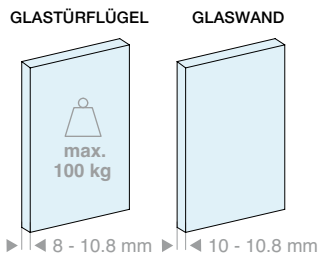
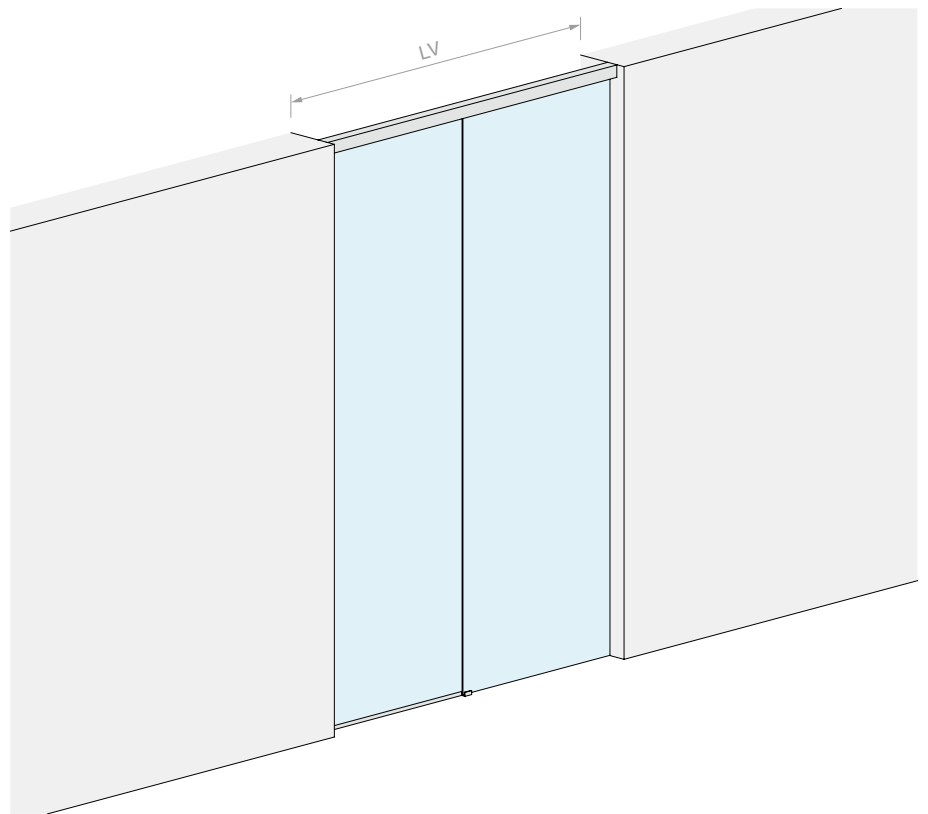

Set bestehend aus:

Art.	Beschreibung	Menge
LM5864S.200	Schiene Deckenbefestigung	1 Stk.
LM0064CP.200	Laufschienenblende	1 Stk.
LMC13.100	Abschlussprofil	1 Stk.
LMU20.300	U-Profil	1 Stk.
LMU20.150	U-Profil	1 Stk.
LMU20TP	Endkappe	1 Stk.
CERPOS162	Klemme	2 Stk.
LMPS-STP55	Stopper ohne Feststeller	2 Stk.
GTUP2	Glashaltedichtung	5 m
LMGF	Bodenführung	1 Stk.

Optional

LMDMP070ZKIT	Doppelt wirkender Dämpfer Set von 40 bis 70 kg	1 Stk.
LMDMP100ZKIT	Doppelt wirkender Dämpfer Set von 70 bis 100 kg	1 Stk.

Set bestehend aus:

Art.	Beschreibung	Menge
LM5864S.300	Schiene Deckenbefestigung	1 Stk.
LM0064CP.300	Laufschienenblende	1 Stk.
LMC13.200	Abschlussprofil	1 Stk.
LMU20.300	U-Profil	2 Stk.
LMU20TP	Endkappe	1 Stk.
CERPOS162	Klemme	2 Stk.
LMPS-STP55	Stopper ohne Feststeller	2 Stk.
GTUP2	Glashaltedichtung	5 m
LMGF	Bodenführung	1 Stk.

Optional

LMDMP070ZKIT	Doppelt wirkender Dämpfer Set von 40 bis 70 kg	1 Stk.
LMDMP100ZKIT	Doppelt wirkender Dämpfer Set von 70 bis 100 kg	1 Stk.

Art.	LV max.	Menge
LMP6511FP.200	2000 mm	1 Stk.

Art.	LV max.	Menge
LMP6511FP.300	3000 mm	1 Stk.

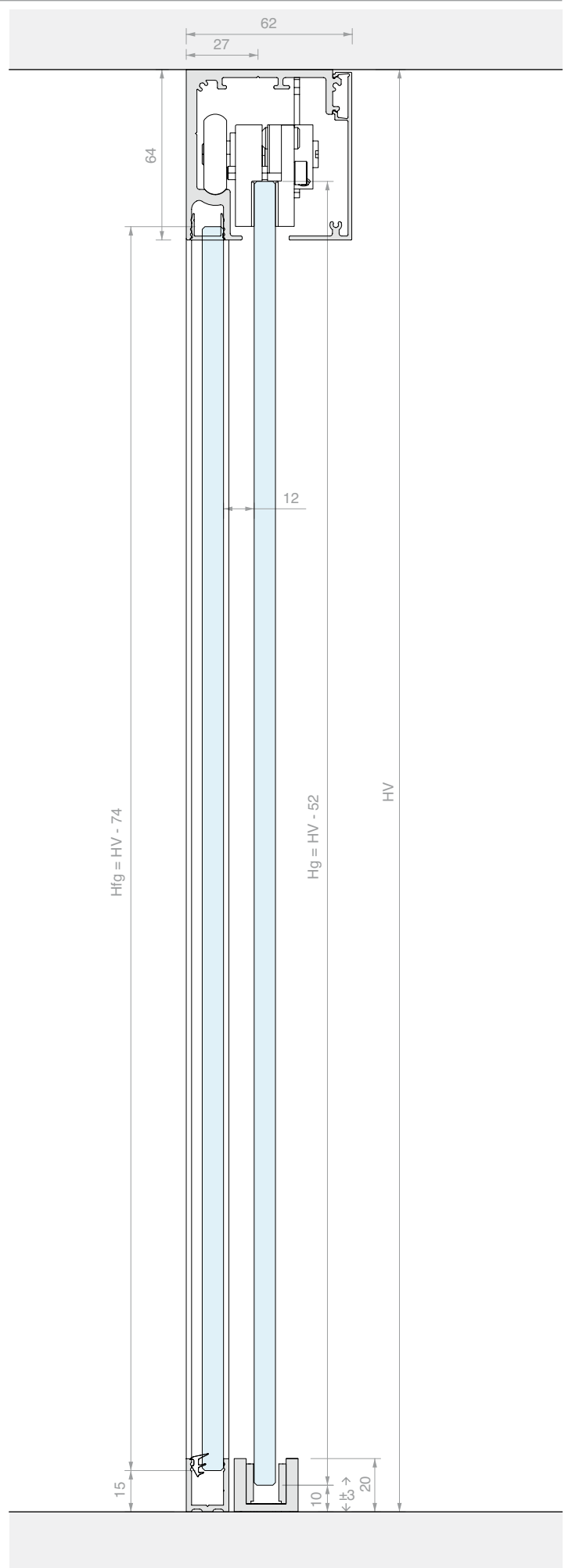
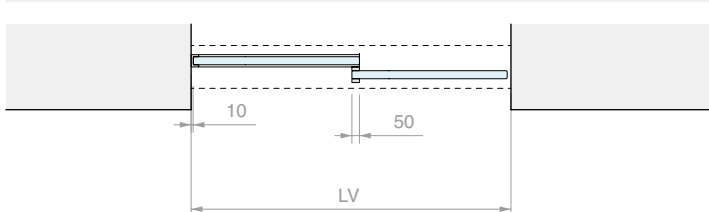
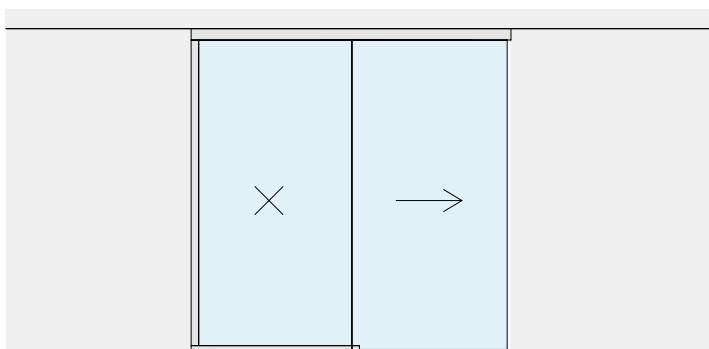
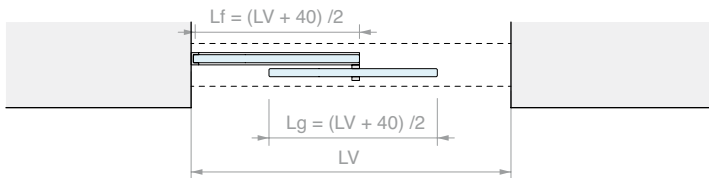
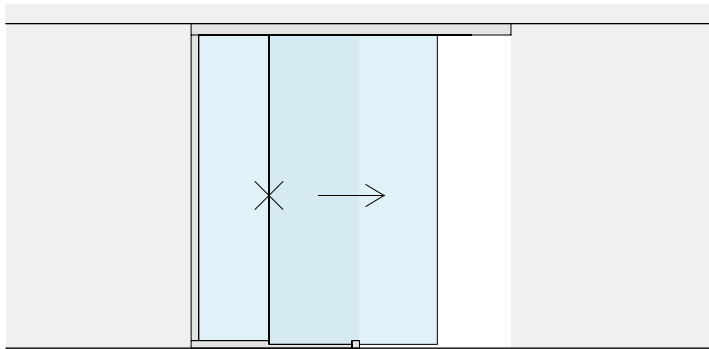
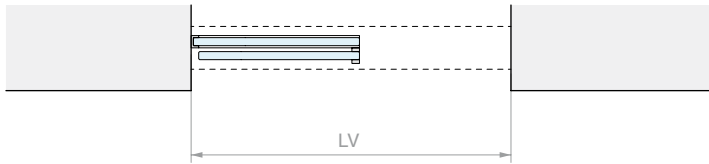
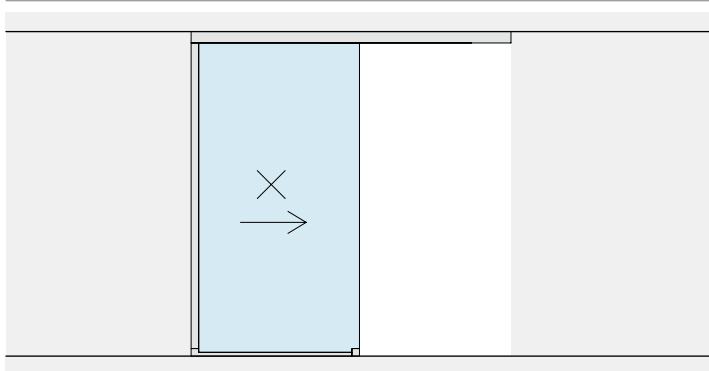







SCHIEBETÜR-SET, DECKENBEFESTIGUNG, ZWEI SYNCHRON LAUFENDE TÜRFLÜGEL UND DOPPELTE GLASWAND

Material: Aluminium

Oberfläche: /6 /88 /97

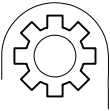
NEUHEIT
2025

WANDÖFFNUNGSMASS

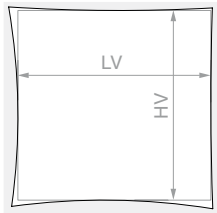

HV max.: 3000 mm

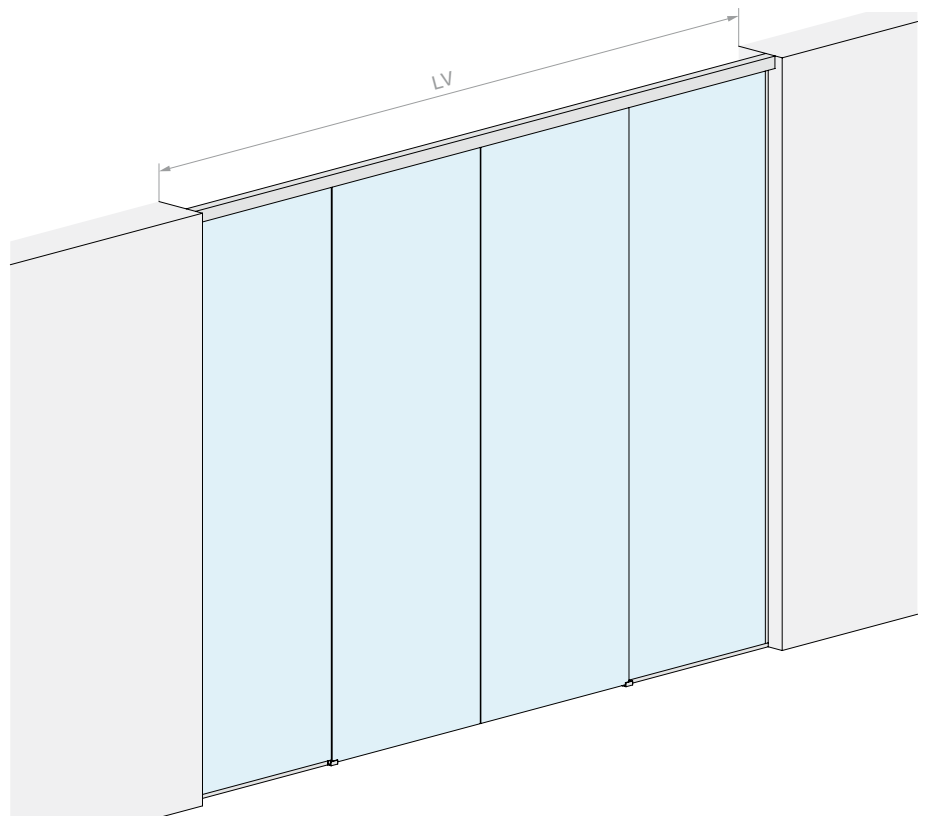

GLASTÜRFLÜGEL

GLASWAND

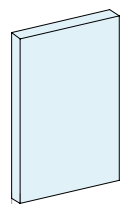
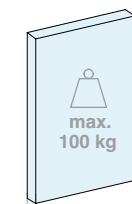

▶ |◀ 8 - 10.8 mm ▶ |◀ 10 - 10.8 mm ▶

Set bestehend aus:

Art.	Beschreibung	Menge
LM5864S.400	Schiene Deckenbefestigung	1 Stk.
LM0064CP.400	Laufschienenblende	1 Stk.
LMC13.200	Abschlussprofil	1 Stk.
LMU20.300	U-Profil	2 Stk.
LMU20.150	U-Profil	2 Stk.
LMU20TP	Endkappe	2 Stk.
CERPOS162	Klemme	4 Stk.
LMPS-STP55	Stopper ohne Feststeller	4 Stk.
GTUP2	Glashaltedichtung	10 m
LMGF	Bodenführung	2 Stk.
LMSIN-AC55	Synchronlauf-Set	1 Stk.
Optional		
LMDMP100ZKIT	Doppelt wirkender Dämpfer Set von 35 bis 50 kg	1 Stk.

Art.	LV max.	Menge
LMP6511CFP.400	4000 mm	1 Stk.

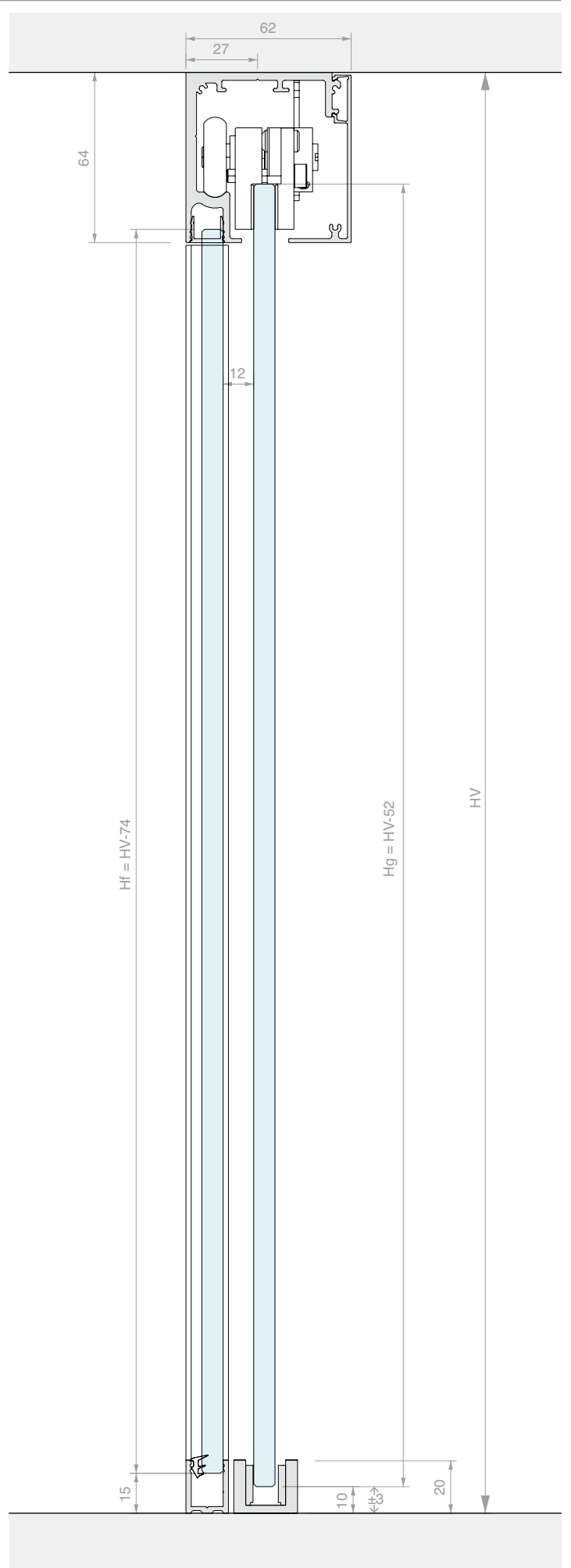
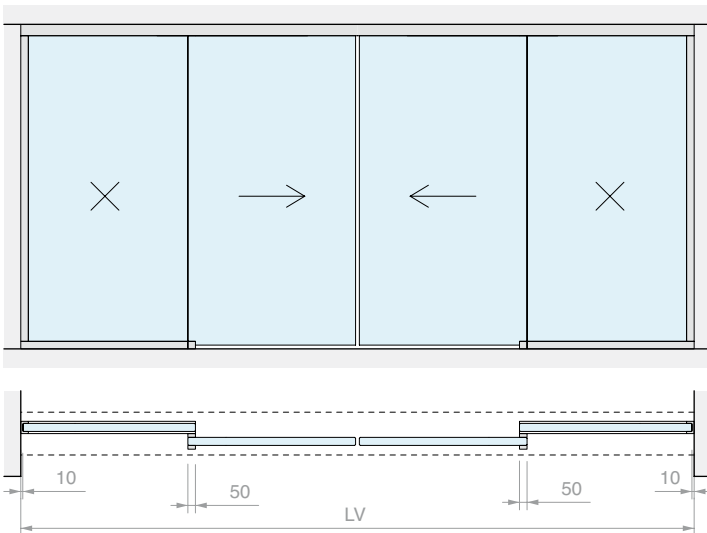
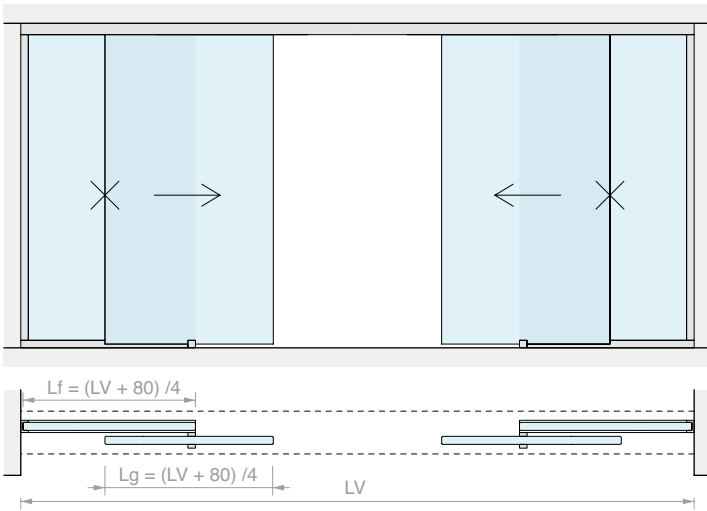
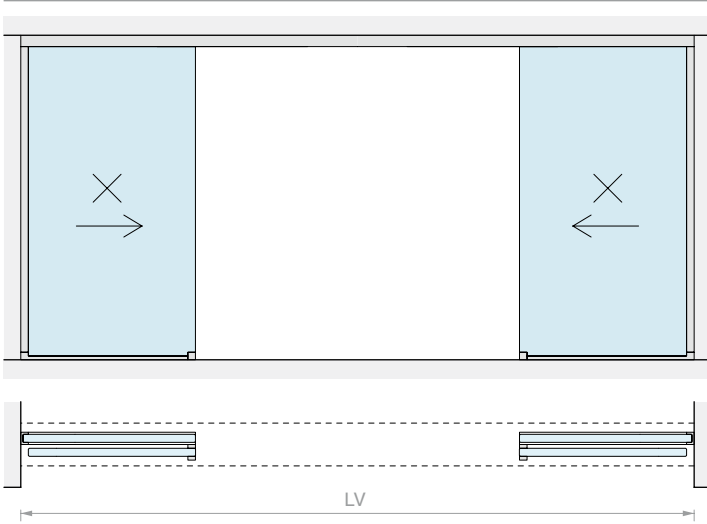





**SCHIEBETÜR-SET, WANDBEFESTIGUNG, EINFLÜGELIG**

Material: Aluminium

Oberfläche: /6 /88 /97

**NEUHEIT
2025**

WANDÖFFNUNGSMASS

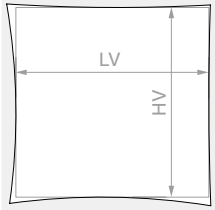

HV max.: 3000 mm

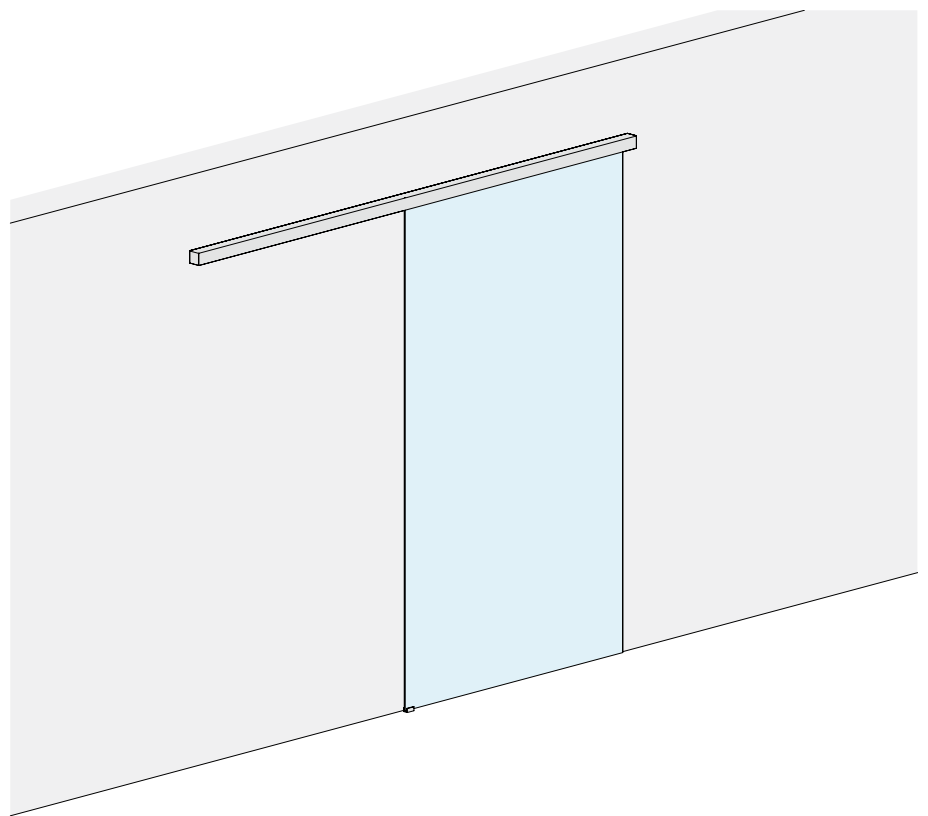

GLASTÜRFLÜGEL



▶ | ◀ 8 - 10.8 mm

GLASTÜRFLÜGEL

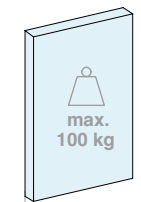

▶ | ◀ 8 - 10.8 mm

Set bestehend aus:

Art.	Beschreibung	Menge
LM5864P.200	Schiene Wandbefestigung	1 Stk.
LM0064CP.200	Laufschienenblende	1 Stk.
LMC13.200	Abschlussprofil	1 Stk.
LM63061TP33	Endkappe	2 Stk.
CERPOS162	Klemme	2 Stk.
LMPS-STP55	Stopper ohne Feststeller	2 Stk.
LMGF	Bodenführung	1 Stk.

Optional

LMDMP070ZKIT	Doppelt wirkender Dämpfer Set von 40 bis 70 kg	1 Stk.
LMDMP100ZKIT	Doppelt wirkender Dämpfer Set von 70 bis 100 kg	1 Stk.

Set bestehend aus:

Art.	Beschreibung	Menge
LM5864P.300	Schiene Wandbefestigung	1 Stk.
LM0064CP.300	Laufschienenblende	1 Stk.
LMC13.300	Abschlussprofil	1 Stk.
LM63061TP33	Endkappe	2 Stk.
CERPOS162	Klemme	2 Stk.
LMPS-STP55	Stopper ohne Feststeller	2 Stk.
LMGF	Bodenführung	1 Stk.

Optional

LMDMP070ZKIT	Doppelt wirkender Dämpfer Set von 40 bis 70 kg	1 Stk.
LMDMP100ZKIT	Doppelt wirkender Dämpfer Set von 70 bis 100 kg	1 Stk.

Art.	LV max.	Menge
LMP6521P.200	920 mm	1 Stk.

Art.	LV max.	Menge
LMP6521P.300	1420 mm	1 Stk.

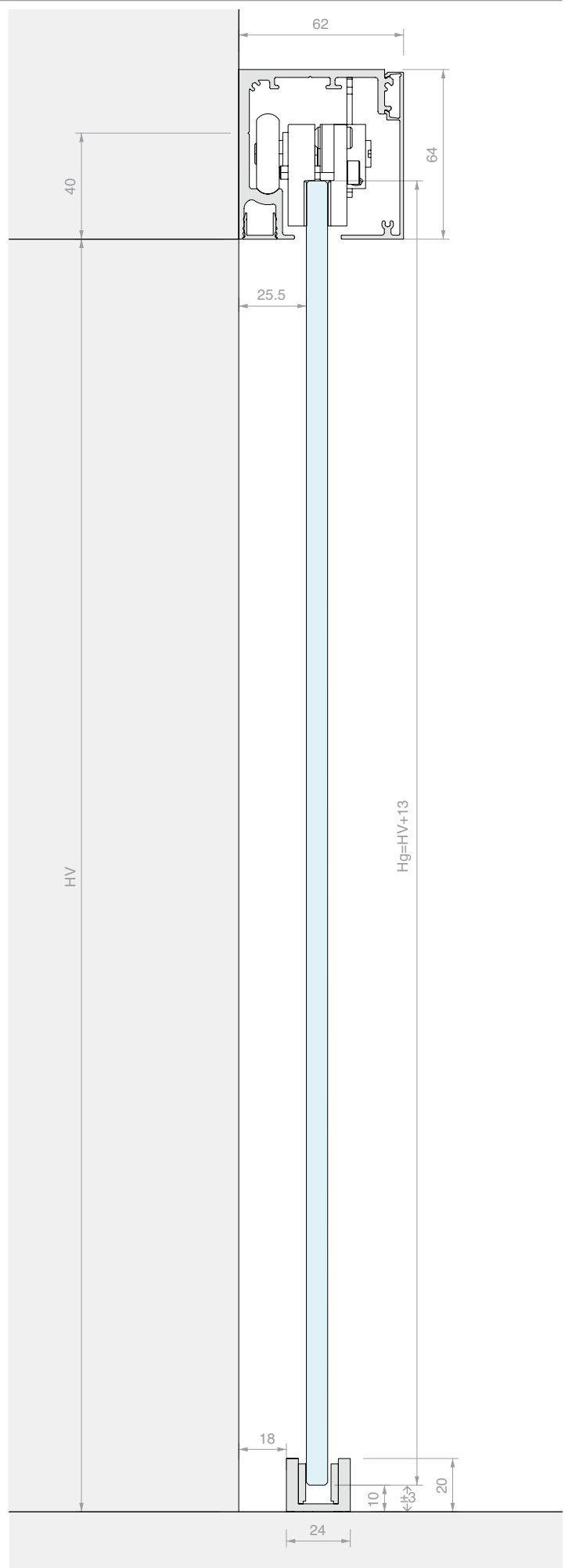
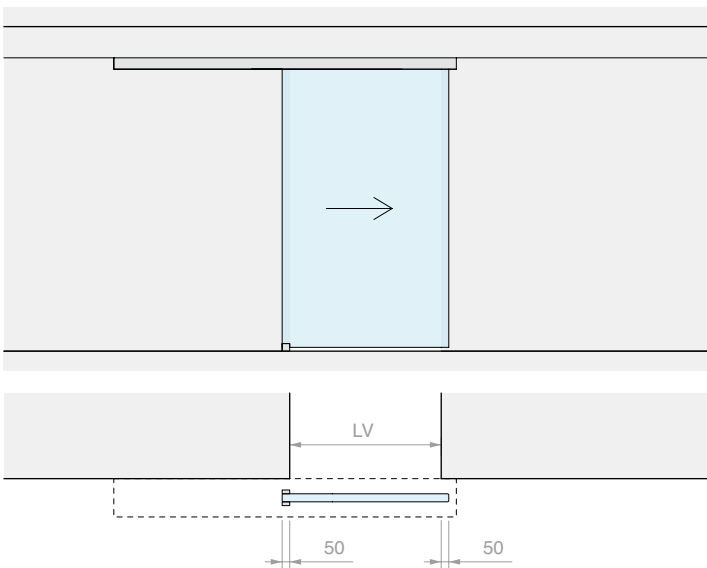
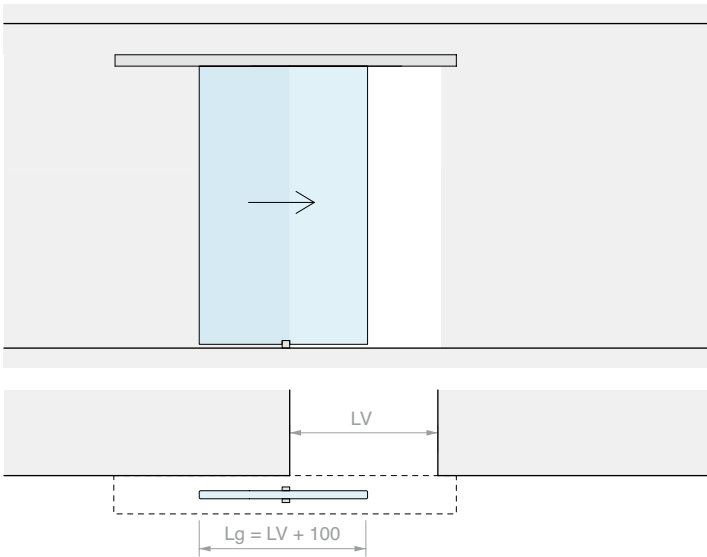
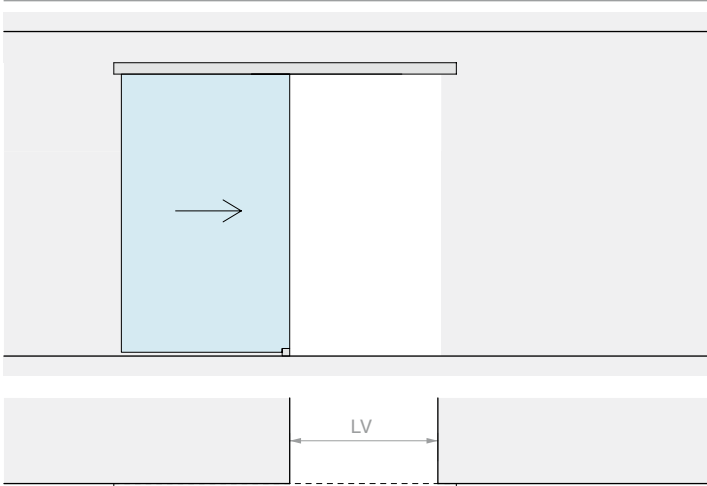

**SCHIEBETÜR-SET, WANDBEFESTIGUNG,
ZWEI SYNCHRON LAUFENDE TÜRFLÜGEL**

Material: Aluminium

Oberfläche: /6 /88 /97

**NEUHEIT
2025**

WANDÖFFNUNGSMASS

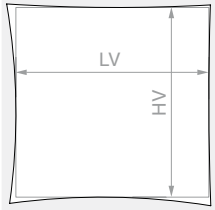

HV max.: 3000 mm

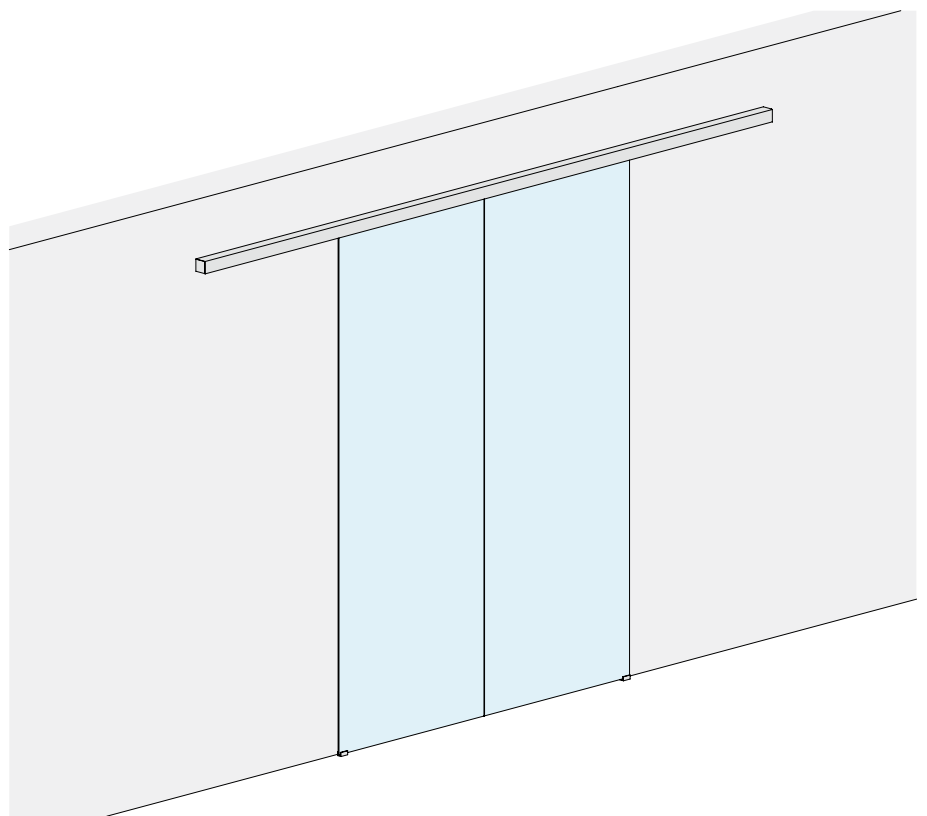

GLASTÜRFLÜGEL

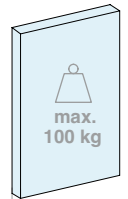

▶ | ◀ 8 - 10.8 mm

Set bestehend aus:

Art.	Beschreibung	Menge
LM5864P.400	Schiene Wandbefestigung	1 Stk.
LM0064CP.400	Laufschienenblende	1 Stk.
LMC13.200	Abschlussprofil	2 Stk.
LM63061TP33	Endkappe	2 Stk.
CERPOS162	Klemme	4 Stk.
LMPS-STP55	Stopper ohne Feststeller	4 Stk.
LMGF	Bodenführung	2 Stk.
LMSIN-AC55	Synchronlauf-Set	1 Stk.

Optional

LMDMP100ZKIT	Doppelt wirkender Dämpfer Set von 35 bis 50 kg	1 Stk.
---------------------	--	--------

Art.	LV max.	Menge
LMP6521CP.400	1940 mm	1 Stk.

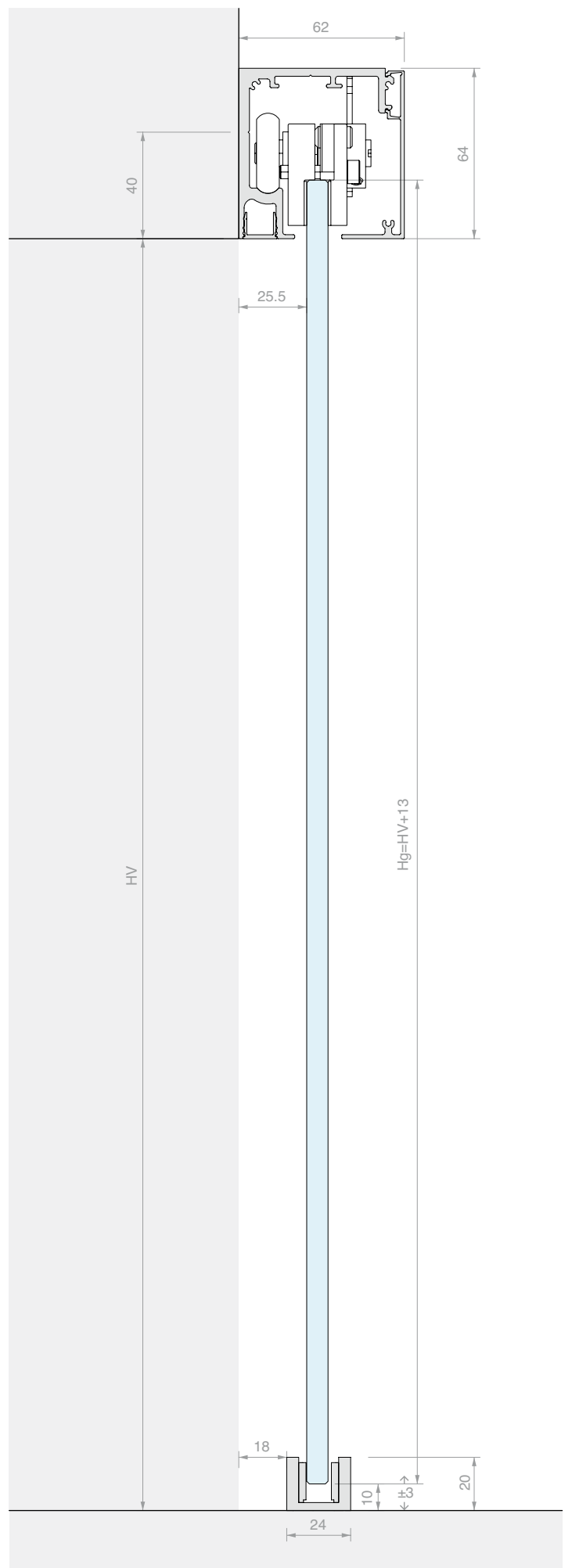
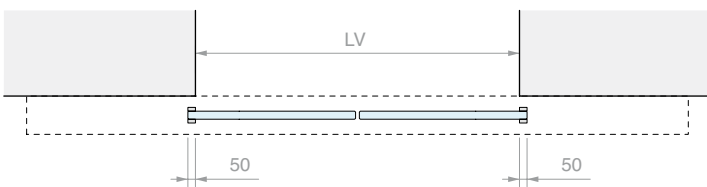
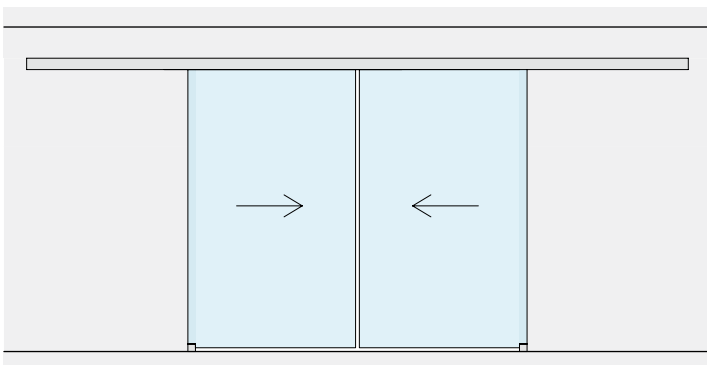
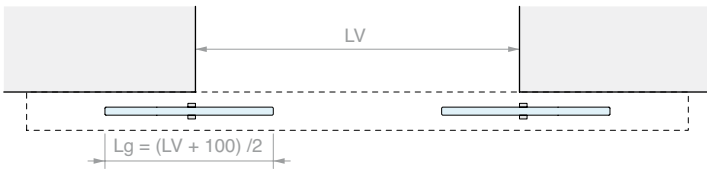
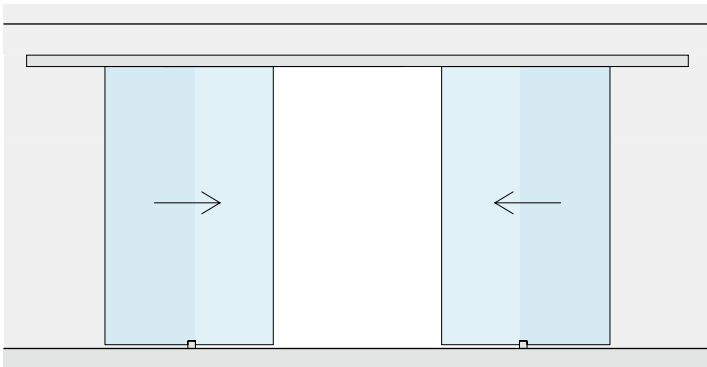
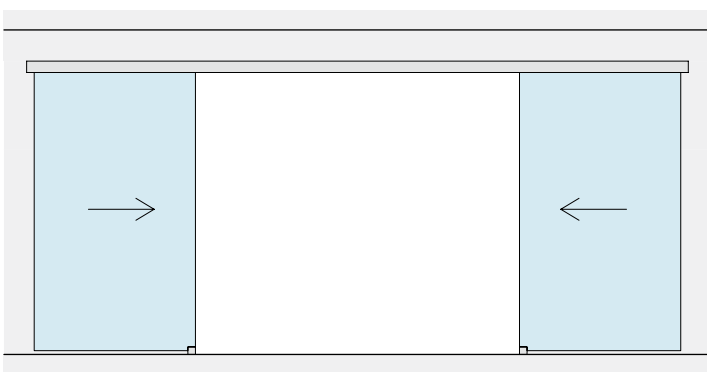





**SCHIEBETÜR-SET, WANDBEFESTIGUNG,
EINFLÜGELIG UND GLASWAND**

Material: Aluminium

Oberfläche: /6 /88 /97

**NEUHEIT
2025**

WANDÖFFNUNGSMASS

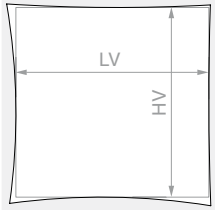

HV max.: 3000 mm

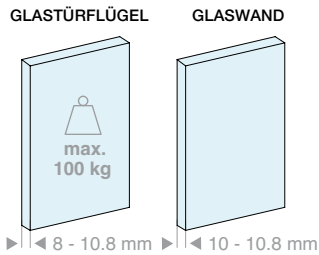
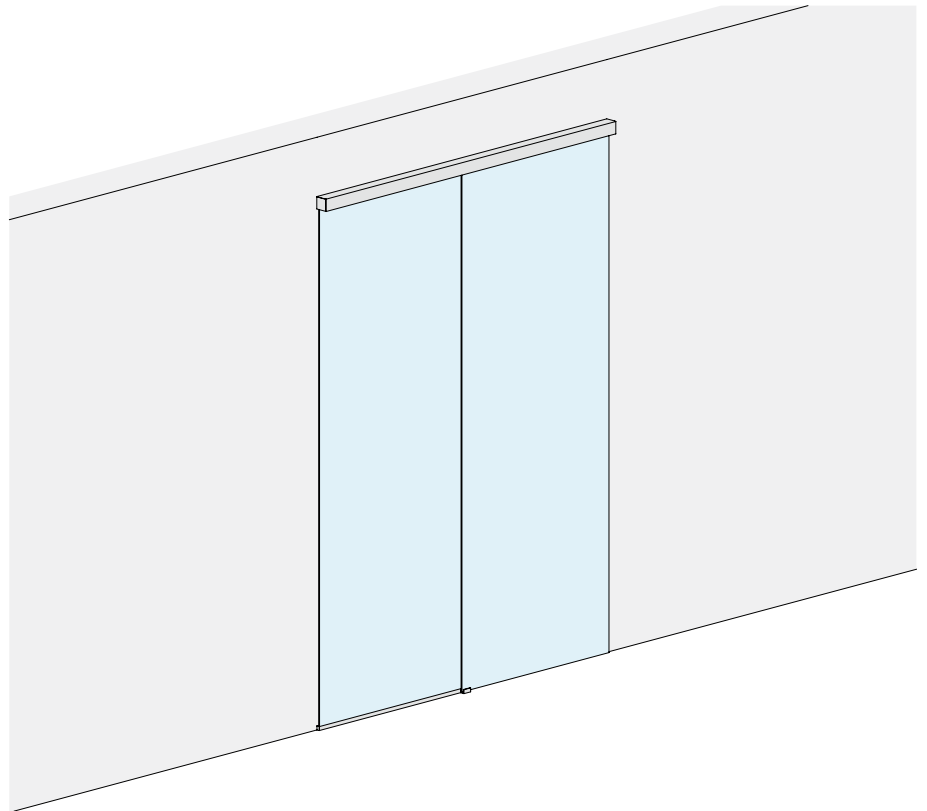

▶ ◀ 8 - 10.8 mm ▶ ◀ 10 - 10.8 mm

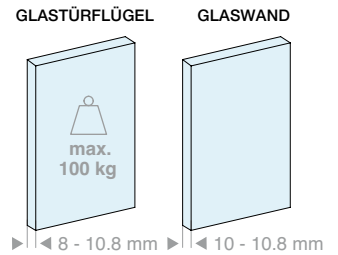

▶ ◀ 8 - 10.8 mm ▶ ◀ 10 - 10.8 mm

Set bestehend aus:

Art.	Beschreibung	Menge
LM5864P.200	Schiene Wandbefestigung	1 Stk.
LM0064CP.200	Laufschienenblende	1 Stk.
LMC13.100	Abschlussprofil	1 Stk.
LMU20.150	U-Profil	1 Stk.
LM63061TP33	Endkappe	2 Stk.
LMU20TP	Endkappe	2 Stk.
CERPOS162	Klemme	2 Stk.
LMPS-STP55	Stopper ohne Feststeller	2 Stk.
GTUP2	Glashaltedichtung	5 m
LMGF	Bodenführung	1 Stk.

Optional

LMDMP070ZKIT	Doppelt wirkender Dämpfer Set von 40 bis 70 kg	1 Stk.
LMDMP100ZKIT	Doppelt wirkender Dämpfer Set von 70 bis 100 kg	1 Stk.

Set bestehend aus:

Art.	Beschreibung	Menge
LM5864P.300	Schiene Wandbefestigung	1 Stk.
LM0064CP.300	Laufschienenblende	1 Stk.
LMC13.200	Abschlussprofil	1 Stk.
LMU20.300	U-Profil	1 Stk.
LM63061TP33	Endkappe	2 Stk.
LMU20TP	Endkappe	2 Stk.
CERPOS162	Klemme	2 Stk.
LMPS-STP55	Stopper ohne Feststeller	2 Stk.
GTUP2	Glashaltedichtung	5 m
LMGF	Bodenführung	1 Stk.

Optional

LMDMP070ZKIT	Doppelt wirkender Dämpfer Set von 40 bis 70 kg	1 Stk.
LMDMP100ZKIT	Doppelt wirkender Dämpfer Set von 70 bis 100 kg	1 Stk.

Art.	LV max.	Menge
LMP6521FP.200	1880 mm	1 Stk.

Art.	LV max.	Menge
LMP6521FP.300	2880 mm	1 Stk.

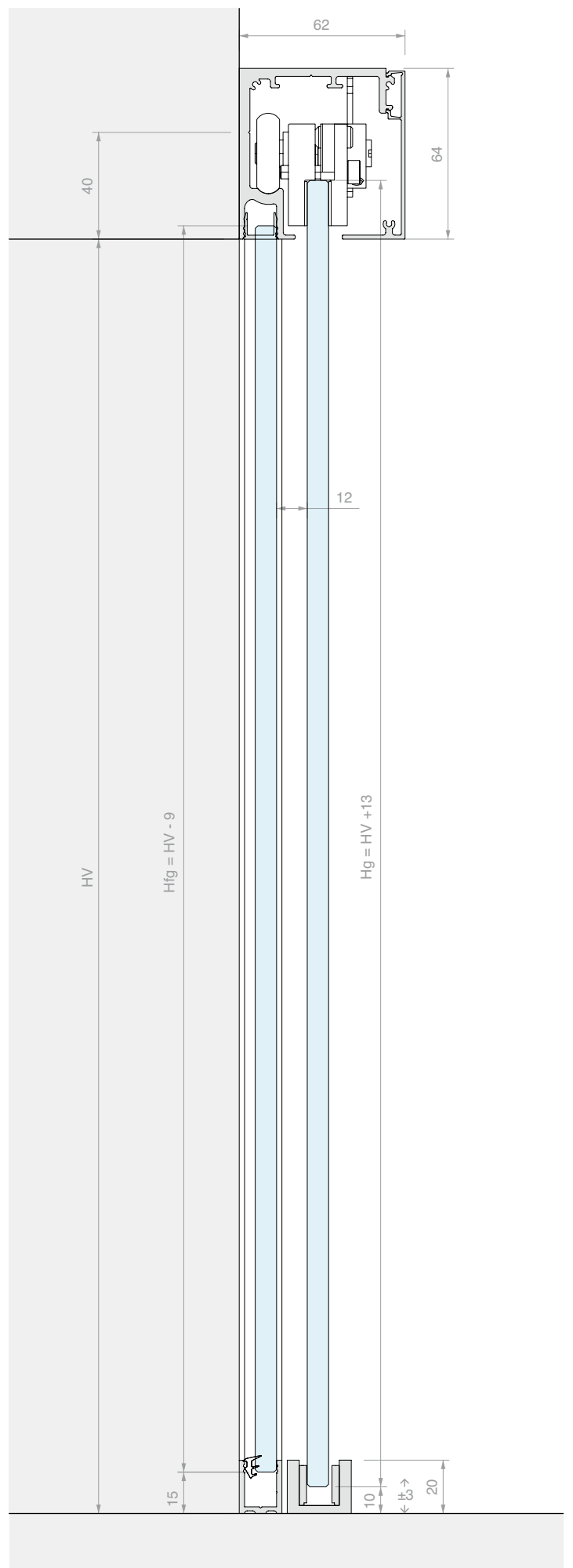
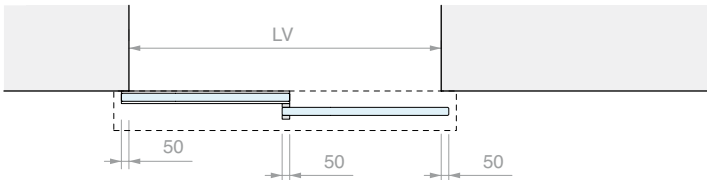
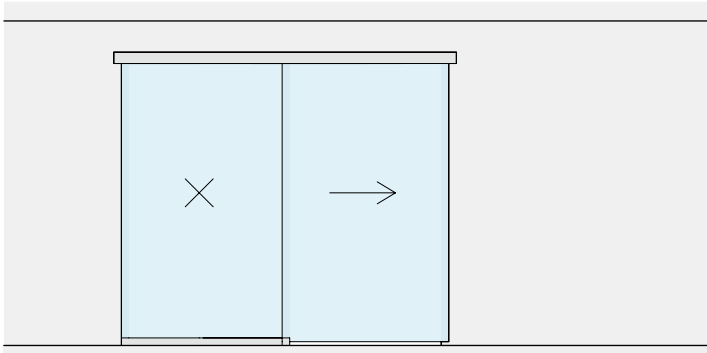
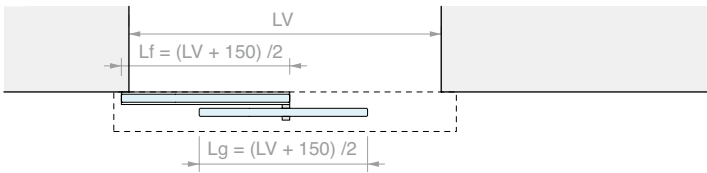
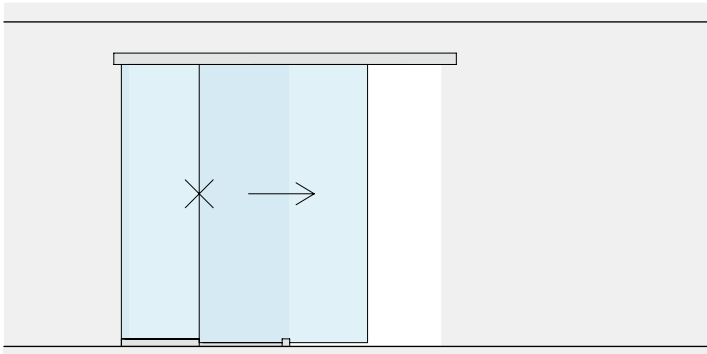
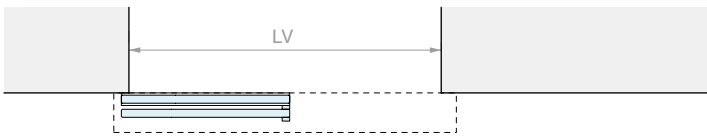
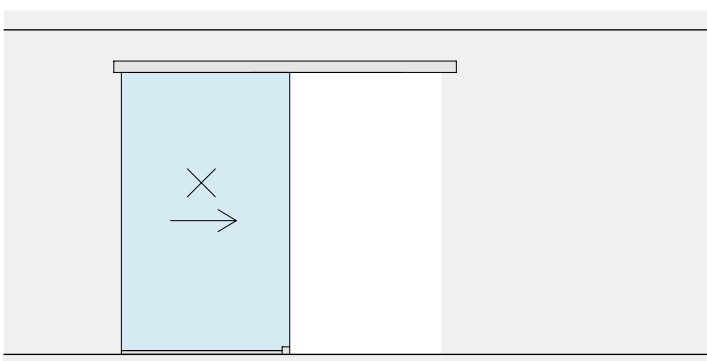



SCHIEBETÜR-SET, WANDBEFESTIGUNG, ZWEI SYNCHRON LAUFENDE TÜRFLÜGEL UND DOPPELTE GLASWAND

Material: Aluminium

Oberfläche: /6 /88 /97

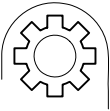
NEUHEIT
2025

WANDÖFFNUNGSMASS

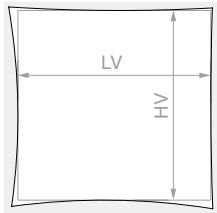

HV max.: 3000 mm

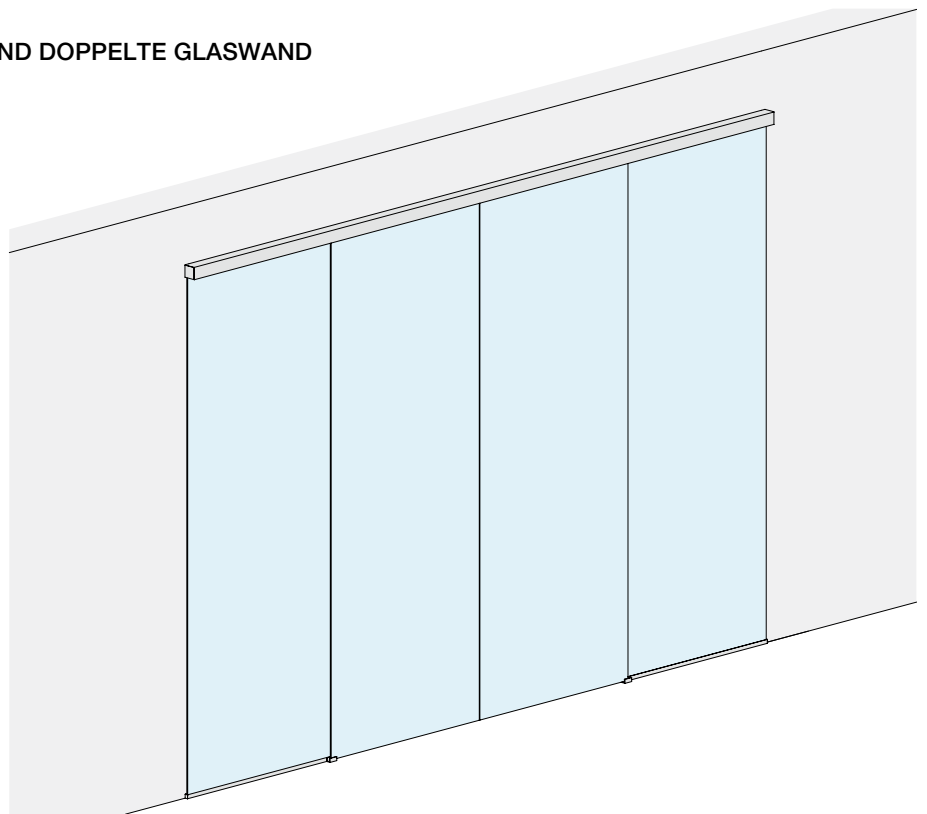

GLASTÜRFLÜGEL

GLASWAND

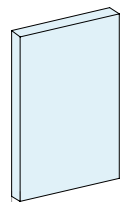
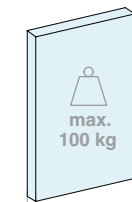

▶ |◀ 8 - 10.8 mm ▶

▶ |◀ 10 - 10.8 mm ▶

Set bestehend aus:

Art.	Beschreibung	Menge
LM5864P.400	Schiene Wandbefestigung	1 Stk.
LM0064CP.400	Laufschienenblende	1 Stk.
LMC13.200	Abschlussprofil	1 Stk.
LMU20.300	U-Profil	1 Stk.
LM63061TP33	Endkappe	2 Stk.
LMU20TP	Endkappe	4 Stk.
CERPOS162	Klemme	4 Stk.
LMPS-STP55	Stopper ohne Feststeller	4 Stk.
GTUP2	Glashaltedichtung	10 m
LMGF	Bodenführung	2 Stk.
LMSIN-AC55	Synchronlauf-Set	1 Stk.

Optional

LMDMP100ZKIT	Doppelt wirkender Dämpfer Set von 35 bis 50 kg	1 Stk.
---------------------	--	--------

Art.	LV max.	Menge
LMP6521CFP.400	3880 mm	1 Stk.

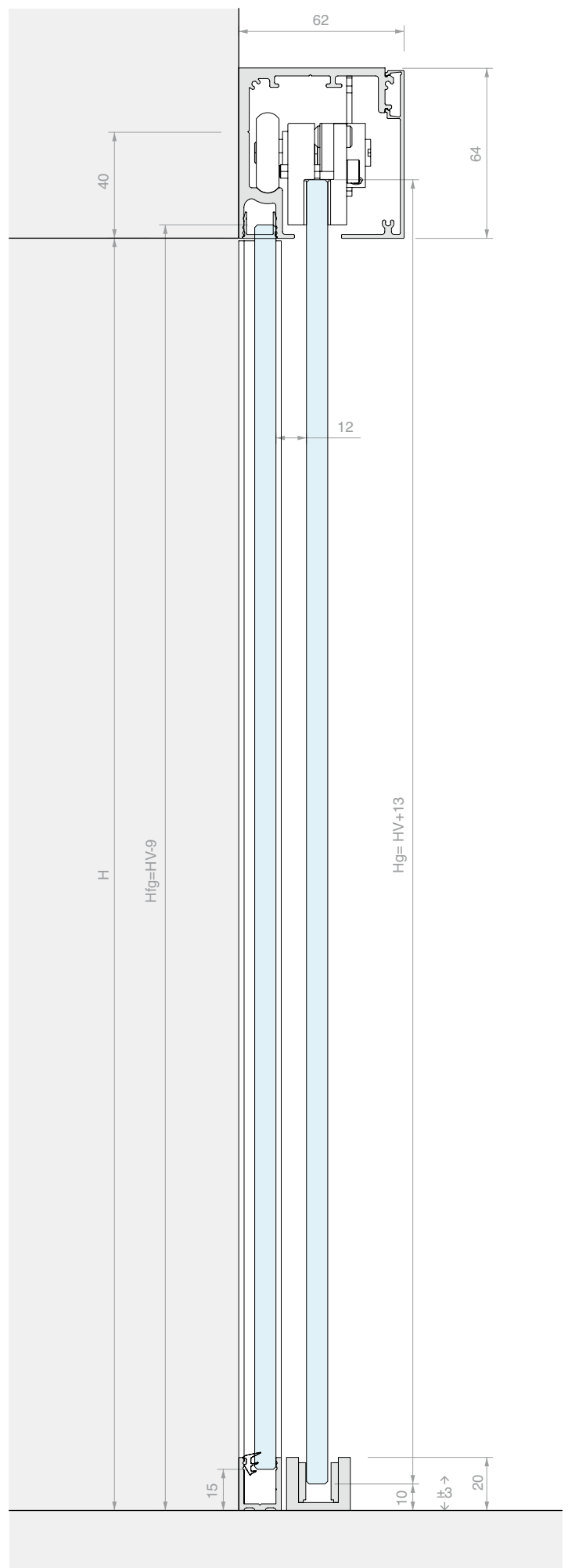
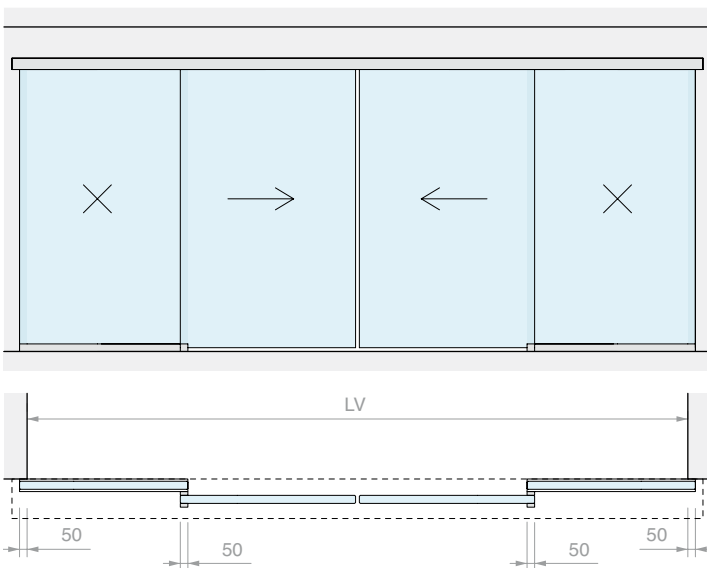
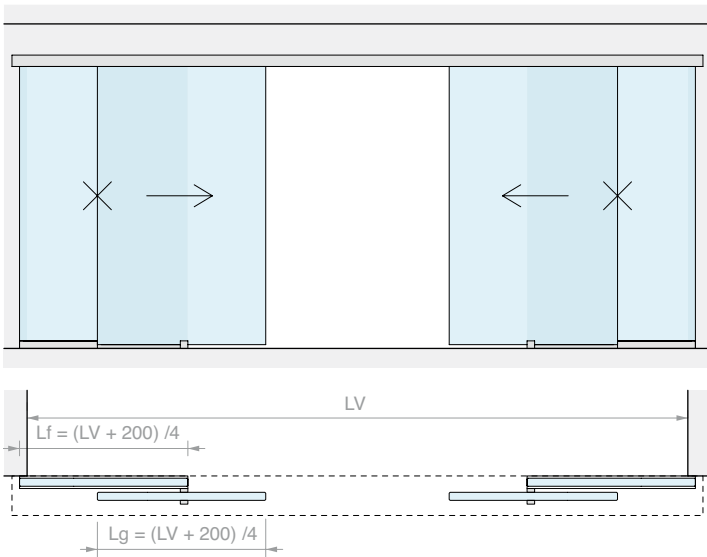
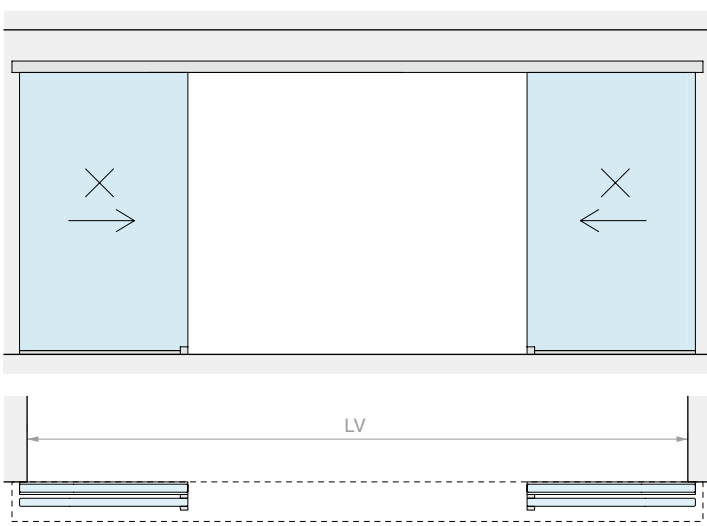



SCHIENE FÜR DECKENBEFESTIGUNG

Material: Aluminium

Oberfläche: /6 /88 /97

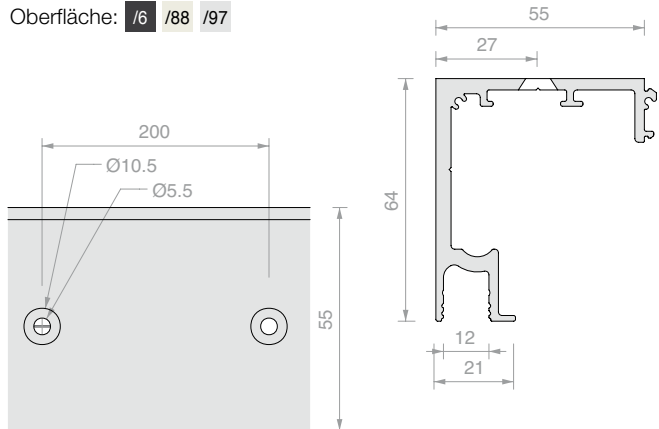

Art.	Länge	Menge
LM5864S.200	1998 mm	1 Stk.
LM5864S.300	2998 mm	1 Stk.
LM5864S.400	3998 mm	1 Stk.
LM5864S.600	6000 mm	1 Stk.



SCHIENE FÜR WANDBEFESTIGUNG

Material: Aluminium

Oberfläche: /6 /88 /97

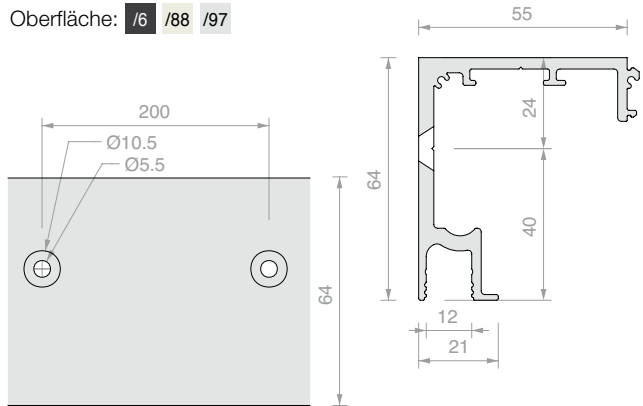

Art.	Länge	Menge
LM5864P.200	1998 mm	1 Stk.
LM5864P.300	2998 mm	1 Stk.
LM5864P.400	3998 mm	1 Stk.
LM5864P.600	6000 mm	1 Stk.



LAUFSCHIENENBLENDE

Material: Aluminium

Oberfläche: /6 /88 /97

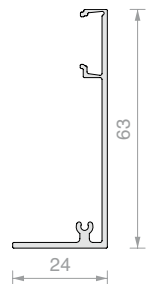

Art.	Länge	Menge
LM0064CP.200	1998 mm	1 Stk.
LM0064CP.300	2998 mm	1 Stk.
LM0064CP.400	3998 mm	1 Stk.
LM0064CP.600	6000 mm	1 Stk.

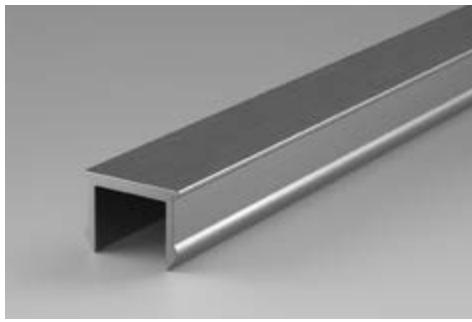

ABSCHLUSSPROFIL

Material: Aluminium

Oberfläche: /6 /88 /97

Art.	Länge	Menge
LMC13.100	996 mm	1 Stk.
LMC13.150	1498 mm	1 Stk.
LMC13.200	1998 mm	1 Stk.
LMC13.300	3000 mm	1 Stk.

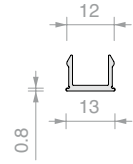

U-PROFIL

Material: Aluminium

Oberfläche: /6 /88 /91 /97

Art.	Länge	Menge
LMU20.100	996 mm	1 Stk.
LMU20.150	1498 mm	1 Stk.
LMU20.300	3000 mm	1 Stk.

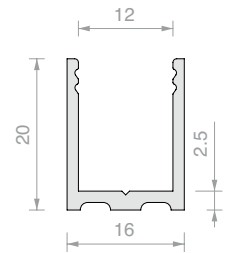

ENDKAPPE

Material: Aluminium

Oberfläche: /88 /91 /97 /R2

Art.	Menge
LMU20TP	1 Stk.

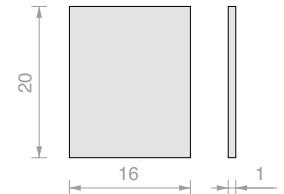

GLASHALTEDICHTUNG

Material: PVC

Art.	Dicke	Farbe	Menge
GTUP2	2 mm	Transparent	1 m
GTUP3	3 mm	Transparent	1 m
GTUP4	4 mm	Transparent	1 m
GTUP5	5 mm	Transparent	1 m
GTUP6	6 mm	Transparent	1 m

Art.	Dicke	Farbe	Menge
GTUP2G	2 mm	Geprägt	1 m
GTUP3G	3 mm	Geprägt	1 m
GTUP4G	4 mm	Geprägt	1 m
GTUP5G	5 mm	Geprägt	1 m
GTUP6G	6 mm	Geprägt	1 m

Art.	Dicke	Farbe	Menge
GTUP2N	2 mm	Schwarz	1 m
GTUP3N	3 mm	Schwarz	1 m
GTUP4N	4 mm	Schwarz	1 m
GTUP5N	5 mm	Schwarz	1 m
GTUP6N	6 mm	Schwarz	1 m



ENDKAPPE 3 SCHRAUBEN

Material: Aluminium

Montage sowohl rechts- wie linksseitig

Oberfläche: /6 /88 /97

Art.	Menge
LM63061TP33	1 Stk.

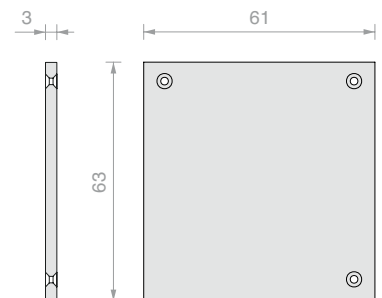



VERSTELLBARE KLEMME MIT ROLLE

Material: Aluminium und Stahl

Art.	Für Glasstärken	Menge
CERPOS162	Von 8 bis 10.8 mm	1 Stk.



STOPPER OHNE FESTSTELLER

Material: Zamak

Art.	Menge
LMPS-STP55	1 Stk.



BODENFÜHRUNG

Material: Aluminium

Oberfläche: /88 /97 /R2

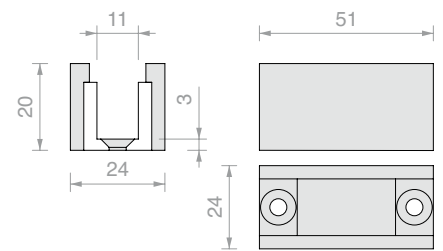

Art.	Für Glasstärken	Menge
LMGF	Von 8 bis 10.8 mm	1 Stk.



KOMPLETTSET DOPPELT WIRKENDER DÄMPFER SOFTBREAK

Material: POM, Aluminium, Zamak

Sorgt für Dämpfung beim Öffnen und Schließen

Art.	Tragfähigkeit	Menge
LMDMP070ZKIT	Von 40 bis 70 kg	1 Stk.
LMDMP100ZKIT	Von 70 bis 100 kg	1 Stk.



DOPPELT WIRKENDER DÄMPFER SOFTBREAK

Material: POM

Sorgt für Dämpfung beim Öffnen und Schließen

Um die Dämpfung zu verwenden, ist es notwendig, eine Klemme und 1/2 Aktivatoren je nach der zu dämpfenden Seite zu installieren

Art.	Tragfähigkeit	Menge
LMDMP070Z	Von 40 bis 70 kg	1 Stk.
LMDMP100Z	Von 70 bis 100 kg	1 Stk.



STÜTZKLEMME FÜR DÄMPFER

Material: Aluminium

Art.	Menge
LMPs-PSD62	1 Stk.



AUSLÖSER FÜR DÄMPFER

Material: Zamak

Art.	Menge
LMSIN-GA55	1 Stk.



SYNCHRONLAUF-SET

Art.	Menge
LMSIN-AC55	1 Stk.

FORME

Profile mit reduzierten Maßen zur Verzierung der Glastüren.
Anbringung auf dem Glas mit Doppelklebeband 0.5 mm,
Silikon oder UV-Verklebung.
Wählen Sie die Anleitung und das passende Zubehör für
den Einbau des Glases und des Rahmenprofils.

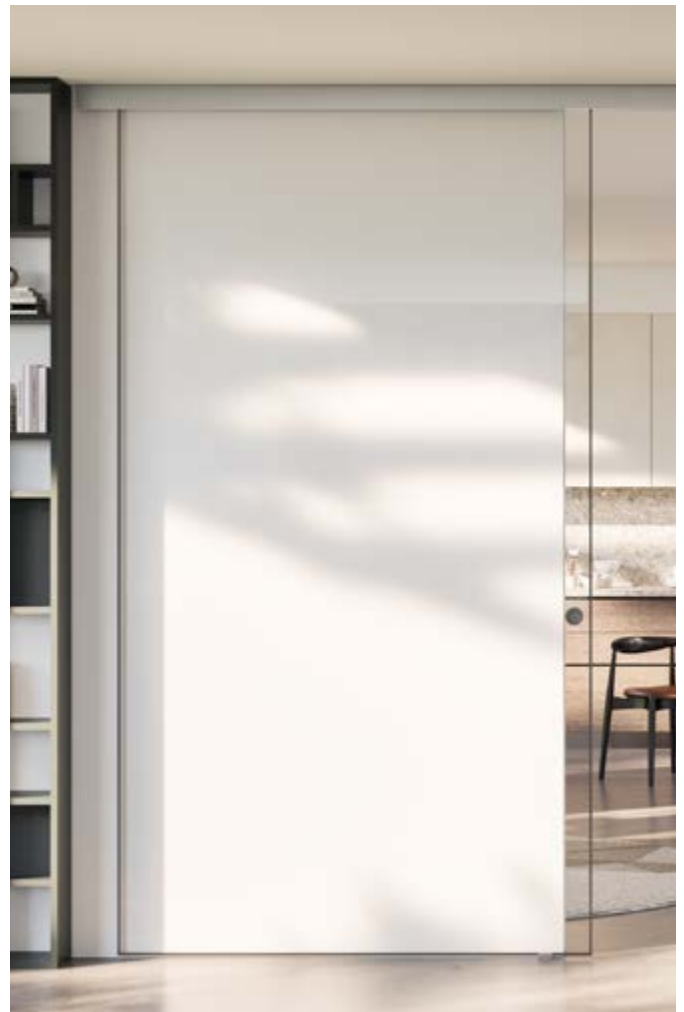



FLACHES PROFIL SERIE FORME

Material: Aluminium

Oberfläche: /6 /88 /97 /RAL

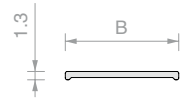

Art.	B	Länge	Menge
FOP10.30	10 mm	3000 mm	1 Stk.
FOP15.30	15 mm	3000 mm	1 Stk.
FOP20.30	20 mm	3000 mm	1 Stk.



U-PROFIL SERIE FORME

Material: Aluminium

Oberfläche: /6 /88 /97 /RAL

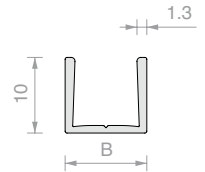

Art.	B	Länge	Für Glasstärken	Menge
FOU1011.30	10.8 mm	3000 mm	8 mm	1 Stk.
FOU1013.30	12.8 mm	3000 mm	10 mm	1 Stk.



DOPPELKLEBEBAND TESA® ACX^{plus}

Transparentes Doppelklebeband für die Befestigung von Glas, Stahl und Aluminium.
Der Liner aus Papier vereinfacht das manuelle Anbringen des Klebebandes.

Art.	Abmessungen	Dicke	Menge
TS250065	6 mm x 25 m	0.5 mm	1 Stk.
TS250125	12 mm x 25 m	0.5 mm	1 Stk.
TS250155	15 mm x 25 m	0.5 mm	1 Stk.



BODENFÜHRUNG

Material: Aluminium

Oberfläche: /88 /97 /R2

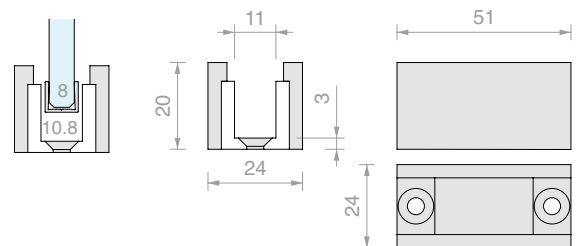

Art.	Für Profil	Menge
LMGF	FOU1011	1 Stk.



ADAPTER FÜR FÜHRUNG LMGF

Zubehör für die Bodenführung LMGF

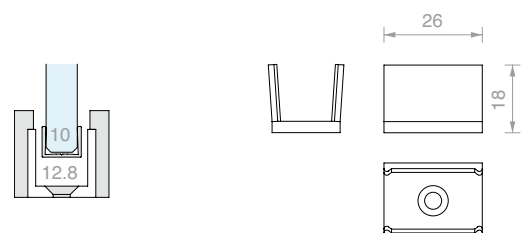

Material: Kunststoff

Oberfläche: /56







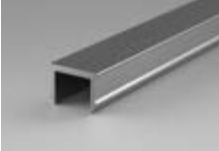

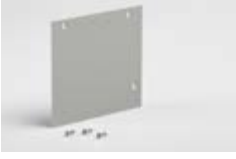



Art.	Für Profil	Menge
LMGF13-POM	FOU1013	1 Stk.

Art.	Beschreibung	Oberfläche	Menge	EURO
LM PORTA PRO SCHIEBETÜR-SET				
	LMP6511P.200/6	Deckenbefestigung, einflügelig, Lvmax 920	Mattschwarz	1 Stk. 587,07
	LMP6511P.200/88	Deckenbefestigung, einflügelig, Lvmax 920	Alu. Edelstahloptik sat.	1 Stk. 578,78
	LMP6511P.200/97	Deckenbefestigung, einflügelig, Lvmax 920	Aluminium matt	1 Stk. 560,14
	LMP6511P.300/6	Deckenbefestigung, einflügelig, Lvmax 1420	Mattschwarz	1 Stk. 663,21
	LMP6511P.300/88	Deckenbefestigung, einflügelig, Lvmax 1420	Alu. Edelstahloptik sat.	1 Stk. 653,66
	LMP6511P.300/97	Deckenbefestigung, einflügelig, Lvmax 1420	Aluminium matt	1 Stk. 630,06
	LMP6511CP.400/6	Deckenbefestigung, zweiflügelig synchron laufend, Lvmax 1940	Mattschwarz	1 Stk. 1.202,28
	LMP6511CP.400/88	Deckenbefestigung, zweiflügelig synchron laufend, Lvmax 1940	Alu. Edelstahloptik sat.	1 Stk. 1.182,85
	LMP6511CP.400/97	Deckenbefestigung, zweiflügelig synchron laufend, Lvmax 1940	Aluminium matt	1 Stk. 1.156,91
	LMP6511FP.200/6	Deckenbefestigung, einflügelig und Glaswand, Lvmax 2000	Mattschwarz	1 Stk. 649,31
	LMP6511FP.200/88	Deckenbefestigung, einflügelig und Glaswand, Lvmax 2000	Alu. Edelstahloptik sat.	1 Stk. 610,04
	LMP6511FP.200/97	Deckenbefestigung, einflügelig und Glaswand, Lvmax 2000	Aluminium matt	1 Stk. 599,39
	LMP6511FP.300/6	Deckenbefestigung, einflügelig und Glaswand, Lvmax 3000	Mattschwarz	1 Stk. 764,87
	LMP6511FP.300/88	Deckenbefestigung, einflügelig und Glaswand, Lvmax 3000	Alu. Edelstahloptik sat.	1 Stk. 696,89
	LMP6511FP.300/97	Deckenbefestigung, einflügelig und Glaswand, Lvmax 3000	Aluminium matt	1 Stk. 679,16
	LMP6511CFP.400/6	Deckenbefestigung, zweiflügelig synchron mit doppelter Glaswand, Lvmax.4000	Mattschwarz	1 Stk. 1.314,74
	LMP6511CFP.400/88	Deckenbefestigung, zweiflügelig synchron mit doppelter Glaswand, Lvmax.4000	Alu. Edelstahloptik sat.	1 Stk. 1.236,22
	LMP6511CFP.400/97	Deckenbefestigung, zweiflügelig synchron mit doppelter Glaswand, Lvmax.4000	Aluminium matt	1 Stk. 1.214,91
	LMP6521P.200/6	Wandbefestigung, einflügelig, Lvmax 920	Mattschwarz	1 Stk. 587,07
	LMP6521P.200/88	Wandbefestigung, einflügelig, Lvmax 920	Alu. Edelstahloptik sat.	1 Stk. 578,78
	LMP6521P.200/97	Wandbefestigung, einflügelig, Lvmax 920	Aluminium matt	1 Stk. 560,14
	LMP6521P.300/6	Wandbefestigung, einflügelig, Lvmax 1420	Mattschwarz	1 Stk. 663,21
	LMP6521P.300/88	Wandbefestigung, einflügelig, Lvmax 1420	Alu. Edelstahloptik sat.	1 Stk. 653,66
	LMP6521P.300/97	Wandbefestigung, einflügelig, Lvmax 1420	Aluminium matt	1 Stk. 630,06
	LMP6521CP.400/6	Wandbefestigung, zweiflügelig synchron laufend, Lvmax 1940	Mattschwarz	1 Stk. 1.202,28
	LMP6521CP.400/88	Wandbefestigung, zweiflügelig synchron laufend, Lvmax 1940	Alu. Edelstahloptik sat.	1 Stk. 1.182,85
	LMP6521CP.400/97	Wandbefestigung, zweiflügelig synchron laufend, Lvmax 1940	Aluminium matt	1 Stk. 1.156,91
	LMP6521FP.200/6	Wandbefestigung, einflügelig und Glaswand, Lvmax 1880	Mattschwarz	1 Stk. 679,69
	LMP6521FP.200/88	Wandbefestigung, einflügelig und Glaswand, Lvmax 1880	Alu. Edelstahloptik sat.	1 Stk. 643,26
	LMP6521FP.200/97	Wandbefestigung, einflügelig und Glaswand, Lvmax 1880	Aluminium matt	1 Stk. 621,28
	LMP6521FP.300/6	Wandbefestigung, einflügelig und Glaswand, Lvmax 2880	Mattschwarz	1 Stk. 795,26
	LMP6521FP.300/88	Wandbefestigung, einflügelig und Glaswand, Lvmax 2880	Alu. Edelstahloptik sat.	1 Stk. 730,11
	LMP6521FP.300/97	Wandbefestigung, einflügelig und Glaswand, Lvmax 2880	Aluminium matt	1 Stk. 701,07
	LMP6521CFP.400/6	Wandbefestigung, zweiflügelig synchron mit doppelter Glaswand, Lvmax 3880	Mattschwarz	1 Stk. 1.345,12
	LMP6521CFP.400/88	Wandbefestigung, zweiflügelig synchron mit doppelter Glaswand, Lvmax 3880	Alu. Edelstahloptik sat.	1 Stk. 1.269,44
	LMP6521CFP.400/97	Wandbefestigung, zweiflügelig synchron mit doppelter Glaswand, Lvmax 3880	Aluminium matt	1 Stk. 1.236,80

	Art.	Beschreibung	Oberfläche	Menge	EURO
	LM5864S.200/6	Laufschiene Deckenbefestigung, B55 H64 L1998	Mattschwarz	1 Stk.	167,60
	LM5864S.200/88	Laufschiene Deckenbefestigung, B55 H64 L1998	Alu. Edelstahloptik sat.	1 Stk.	165,22
	LM5864S.200/97	Laufschiene Deckenbefestigung, B55 H64 L1998	Aluminium matt	1 Stk.	155,74
	LM5864S.300/6	Laufschiene Deckenbefestigung, B55 H64 L2998	Mattschwarz	1 Stk.	242,13
	LM5864S.300/88	Laufschiene Deckenbefestigung, B55 H64 L2998	Alu. Edelstahloptik sat.	1 Stk.	238,57
	LM5864S.300/97	Laufschiene Deckenbefestigung, B55 H64 L2998	Aluminium matt	1 Stk.	224,36
	LM5864S.400/6	Laufschiene Deckenbefestigung, B55 H64 L3998	Mattschwarz	1 Stk.	316,67
	LM5864S.400/88	Laufschiene Deckenbefestigung, B55 H64 L3998	Alu. Edelstahloptik sat.	1 Stk.	311,92
	LM5864S.400/97	Laufschiene Deckenbefestigung, B55 H64 L3998	Aluminium matt	1 Stk.	293,00
	LM5864S.600/6	Laufschiene Deckenbefestigung, B55 H64 L6000	Mattschwarz	1 Stk.	448,80
	LM5864S.600/88	Laufschiene Deckenbefestigung, B55 H64 L6000	Alu. Edelstahloptik sat.	1 Stk.	441,67
LM5864S.600/97	Laufschiene Deckenbefestigung, B55 H64 L6000	Aluminium matt	1 Stk.	413,27	
	LM5864P.200/6	Laufschiene Wandbefestigung, B55 H64 L1998	Mattschwarz	1 Stk.	167,60
	LM5864P.200/88	Laufschiene Wandbefestigung, B55 H64 L1998	Alu. Edelstahloptik sat.	1 Stk.	165,22
	LM5864P.200/97	Laufschiene Wandbefestigung, B55 H64 L1998	Aluminium matt	1 Stk.	155,74
	LM5864P.300/6	Laufschiene Wandbefestigung, B55 H64 L2998	Mattschwarz	1 Stk.	242,13
	LM5864P.300/88	Laufschiene Wandbefestigung, B55 H64 L2998	Alu. Edelstahloptik sat.	1 Stk.	238,57
	LM5864P.300/97	Laufschiene Wandbefestigung, B55 H64 L2998	Aluminium matt	1 Stk.	224,36
	LM5864P.400/6	Laufschiene Wandbefestigung, B55 H64 L3998	Mattschwarz	1 Stk.	316,67
	LM5864P.400/88	Laufschiene Wandbefestigung, B55 H64 L3998	Alu. Edelstahloptik sat.	1 Stk.	311,92
	LM5864P.400/97	Laufschiene Wandbefestigung, B55 H64 L3998	Aluminium matt	1 Stk.	293,00
	LM5864P.600/6	Laufschiene Wandbefestigung, B55 H64 L6000	Mattschwarz	1 Stk.	448,80
	LM5864P.600/88	Laufschiene Wandbefestigung, B55 H64 L6000	Alu. Edelstahloptik sat.	1 Stk.	441,67
LM5864P.600/97	Laufschiene Wandbefestigung, B55 H64 L6000	Aluminium matt	1 Stk.	413,27	
	LM0064CP.200/6	Laufschieneblende, B25.7 H63 L1998	Mattschwarz	1 Stk.	52,14
	LM0064CP.200/88	Laufschieneblende, B25.7 H63 L1998	Alu. Edelstahloptik sat.	1 Stk.	51,52
	LM0064CP.200/97	Laufschieneblende, B25.7 H63 L1998	Aluminium matt	1 Stk.	49,06
	LM0064CP.300/6	Laufschieneblende, B25.7 H63 L2998	Mattschwarz	1 Stk.	68,97
	LM0064CP.300/88	Laufschieneblende, B25.7 H63 L2998	Alu. Edelstahloptik sat.	1 Stk.	68,02
	LM0064CP.300/97	Laufschieneblende, B25.7 H63 L2998	Aluminium matt	1 Stk.	64,33
	LM0064CP.400/6	Laufschieneblende, B25.7 H63 L3998	Mattschwarz	1 Stk.	85,78
	LM0064CP.400/88	Laufschieneblende, B25.7 H63 L3998	Alu. Edelstahloptik sat.	1 Stk.	84,55
	LM0064CP.400/97	Laufschieneblende, B25.7 H63 L3998	Aluminium matt	1 Stk.	79,62
	LM0064CP.600/6	Laufschieneblende, B25.7 H63 L6000	Mattschwarz	1 Stk.	102,45
	LM0064CP.600/88	Laufschieneblende, B25.7 H63 L6000	Alu. Edelstahloptik sat.	1 Stk.	100,61
LM0064CP.600/97	Laufschieneblende, B25.7 H63 L6000	Aluminium matt	1 Stk.	93,21	
	LMC13.100/6	Abschlussprofil, L996	Mattschwarz	1 Stk.	14,87
	LMC13.100/88	Abschlussprofil, L996	Alu. Edelstahloptik sat.	1 Stk.	14,45
	LMC13.100/97	Abschlussprofil, L996	Aluminium matt	1 Stk.	14,06
	LMC13.150/6	Abschlussprofil, L1498	Mattschwarz	1 Stk.	18,30
	LMC13.150/88	Abschlussprofil, L1498	Alu. Edelstahloptik sat.	1 Stk.	17,69
	LMC13.150/97	Abschlussprofil, L1498	Aluminium matt	1 Stk.	17,09
	LMC13.200/6	Abschlussprofil, L1998	Mattschwarz	1 Stk.	19,18
	LMC13.200/88	Abschlussprofil, L1998	Alu. Edelstahloptik sat.	1 Stk.	18,44
	LMC13.200/97	Abschlussprofil, L1998	Aluminium matt	1 Stk.	17,75
	LMC13.300/6	Abschlussprofil, L3000	Mattschwarz	1 Stk.	20,28

	Art.	Beschreibung	Oberfläche	Menge	EURO
	LMC13.300/88	Abschlussprofil, L3000	Alu. Edeltstahl optik sat.	1 Stk.	19,05
	LMC13.300/97	Abschlussprofil, L3000	Aluminium matt	1 Stk.	17,95
	LMU20.100/6	U-Profil, B16 H20 L996	Mattschwarz	1 Stk.	35,35
	LMU20.100/88	U-Profil, B16 H20 L996	Alu. Edeltstahl optik sat.	1 Stk.	31,02
	LMU20.100/91	U-Profil, B16 H20 L996	Aluminium glänzend	1 Stk.	32,85
	LMU20.100/97	U-Profil, B16 H20 L996	Aluminium matt	1 Stk.	29,48
	LMU20.150/6	U-Profil, B16 H20 L1498	Mattschwarz	1 Stk.	48,40
	LMU20.150/88	U-Profil, B16 H20 L1498	Alu. Edeltstahl optik sat.	1 Stk.	38,43
	LMU20.150/91	U-Profil, B16 H20 L1498	Aluminium glänzend	1 Stk.	40,19
	LMU20.150/97	U-Profil, B16 H20 L1498	Aluminium matt	1 Stk.	36,15
	LMU20.300/6	U-Profil, B16 H20 L3000	Mattschwarz	1 Stk.	71,28
	LMU20.300/88	U-Profil, B16 H20 L3000	Alu. Edeltstahl optik sat.	1 Stk.	56,06
	LMU20.300/91	U-Profil, B16 H20 L3000	Aluminium glänzend	1 Stk.	59,40
	LMU20.300/97	U-Profil, B16 H20 L3000	Aluminium matt	1 Stk.	51,59
	LMU20TP/88	Flache Endkappe, B16 H20 L1	Alu. Edeltstahl optik sat.	1 Stk.	6,36
	LMU20TP/91	Flache Endkappe, B16 H20 L1	Aluminium glänzend	1 Stk.	6,36
	LMU20TP/97	Flache Endkappe, B16 H20 L1	Aluminium matt	1 Stk.	6,25
	LMU20TP/R2	Flache Endkappe, B16 H20 L1	RAL9005 Mattschwarz	1 Stk.	7,70
	GTUP2	Glashaltedichtung, H2	Transparent	1 m	1,21
	GTUP3	Glashaltedichtung, H3	Transparent	1 m	1,39
	GTUP4	Glashaltedichtung, H4	Transparent	1 m	1,69
	GTUP5	Glashaltedichtung, H5	Transparent	1 m	2,35
	GTUP6	Glashaltedichtung, H6	Transparent	1 m	3,30
	GTUP2G	Glashaltedichtung, H2	Gaufiert	1 m	1,80
	GTUP3G	Glashaltedichtung, H3	Gaufiert	1 m	2,02
	GTUP4G	Glashaltedichtung, H4	Gaufiert	1 m	2,29
	GTUP5G	Glashaltedichtung, H5	Gaufiert	1 m	2,60
	GTUP6G	Glashaltedichtung, H6	Gaufiert	1 m	3,81
	GTUP2N	Glashaltedichtung schwarz, H2	Schwarz	1 m	1,21
	GTUP3N	Glashaltedichtung schwarz, H3	Schwarz	1 m	1,39
	GTUP4N	Glashaltedichtung schwarz, H4	Schwarz	1 m	1,69
	GTUP5N	Glashaltedichtung schwarz, H5	Schwarz	1 m	2,35
GTUP6N	Glashaltedichtung schwarz, H6	Schwarz	1 m	3,30	
	LM63061TP33/6	Abschlusskappe mit 3 Schrauben, B61 H63	Mattschwarz	1 Stk.	24,68
	LM63061TP33/88	Abschlusskappe mit 3 Schrauben, B61 H63	Alu. Edeltstahl optik sat.	1 Stk.	24,68
	LM63061TP33/97	Abschlusskappe mit 3 Schrauben, B61 H63	Aluminium matt	1 Stk.	23,17
	CERPOS162	Klemme für Schiebetüren, verstellbar mit Rolle, für 8/10.8 mm Glas		1 Stk.	146,74
	LMPS-STP55	Puffer ohne Feststeller		1 Stk.	18,83
	LMGF/88	Bodenführung, für 8/10.8 mm Glas, B25 H23 L46	Alu. Edeltstahl optik sat.	1 Stk.	26,31
	LMGF/97	Bodenführung, für 8/10.8 mm Glas, B25 H23 L46	Aluminium matt	1 Stk.	26,31
	LMGF/R2	Bodenführung, für 8/10.8 mm Glas, B25 H23 L46	RAL9005 Mattschwarz	1 Stk.	31,59

	Art.	Beschreibung	Oberfläche	Menge	EURO
	LMDMP070ZKIT	Komplettset doppelt wirkender Dämpfer Softbreak von 40 bis 70 kg		1 Stk.	121,68
	LMDMP100ZKIT	Komplettset doppelt wirkender Dämpfer Softbreak von 70 bis 100 kg		1 Stk.	121,68
	LMDMP070Z	Doppelt wirkender Dämpfer Softbreak von 40 bis 70 kg		1 Stk.	67,54
	LMDMP100Z	Doppelt wirkender Dämpfer Softbreak von 70 bis 100 kg		1 Stk.	67,54
	LMPS-PSD62	Stützklemme für Dämpfer		1 Stk.	21,19
	LMSIN-GA55	Auslöser für Dämpfer		1 Stk.	16,48
	LMSIN-AC55	Synchronlauf-Set		1 Stk.	133,54
	FOP10.30/6	Flaches Profil FORME, B10 H1.3 L3000	Mattschwarz	1 Stk.	33,32
	FOP10.30/88	Flaches Profil FORME, B10 H1.3 L3000	Alu. Edeltstahloptik sat.	1 Stk.	33,32
	FOP10.30/97	Flaches Profil FORME, B10 H1.3 L3000	Aluminium matt	1 Stk.	25,00
	FOP10.30/RAL	Flaches Profil FORME, B10 H1.3 L3000	RAL9010 Weiß glänzend	1 Stk.	29,16
	FOP15.30/6	Flaches Profil FORME, B15 H1.3 L3000	Mattschwarz	1 Stk.	35,34
	FOP15.30/88	Flaches Profil FORME, B15 H1.3 L3000	Alu. Edeltstahloptik sat.	1 Stk.	35,34
	FOP15.30/97	Flaches Profil FORME, B15 H1.3 L3000	Aluminium matt	1 Stk.	27,02
	FOP15.30/RAL	Flaches Profil FORME, B15 H1.3 L3000	RAL9010 Weiß glänzend	1 Stk.	31,18
	FOP20.30/6	Flaches Profil FORME, B20 H1.3 L3000	Mattschwarz	1 Stk.	37,98
	FOP20.30/88	Flaches Profil FORME, B20 H1.3 L3000	Alu. Edeltstahloptik sat.	1 Stk.	37,98
	FOP20.30/97	Flaches Profil FORME, B20 H1.3 L3000	Aluminium matt	1 Stk.	29,68
	FOP20.30/RAL	Flaches Profil FORME, B20 H1.3 L3000	RAL9010 Weiß glänzend	1 Stk.	33,82
	FOU1011.30/6	Flaches U-Profil FORME, für 8 mm Glas, B10.8 H10 L3000	Mattschwarz	1 Stk.	47,24
	FOU1011.30/88	Flaches U-Profil FORME, für 8 mm Glas, B10.8 H10 L3000	Alu. Edeltstahloptik sat.	1 Stk.	47,24
	FOU1011.30/97	Flaches U-Profil FORME, für 8 mm Glas, B10.8 H10 L3000	Aluminium matt	1 Stk.	38,92
	FOU1011.30/RAL	Flaches U-Profil FORME, für 8 mm Glas, B10.8 H10 L3000	RAL9010 Weiß glänzend	1 Stk.	43,08
	FOU1013.30/6	Flaches U-Profil FORME, für 10 mm Glas, B12.8 H10 L3000	Mattschwarz	1 Stk.	50,02
	FOU1013.30/88	Flaches U-Profil FORME, für 10 mm Glas, B12.8 H10 L3000	Alu. Edeltstahloptik sat.	1 Stk.	50,02
	FOU1013.30/97	Flaches U-Profil FORME, für 10 mm Glas, B12.8 H10 L3000	Aluminium matt	1 Stk.	41,70
FOU1013.30/RAL	Flaches U-Profil FORME, für 10 mm Glas, B12.8 H10 L3000	RAL9010 Weiß glänzend	1 Stk.	45,86	
	TS250065	Doppelklebeband Tesa® ACXplus, B6 H0.5 L25 m	Transparent	1 Stk.	33,26
	TS250125	Doppelklebeband Tesa® ACXplus, B12 H0.5 L25m	Transparent	1 Stk.	66,52
	TS250155	Doppelklebeband Tesa® ACXplus, B15 H0.5 L25m	Transparent	1 Stk.	105,50
	LMGF/88	Bodenführung, für 8/10.8 mm Glas, B25 H23 L46	Alu. Edeltstahloptik sat.	1 Stk.	26,32
	LMGF/97	Bodenführung, für 8/10.8 mm Glas, B25 H23 L46	Aluminium matt	1 Stk.	26,32
	LMGF/R2	Bodenführung, für 8/10.8 mm Glas, B25 H23 L46	RAL9005 Mattschwarz	1 Stk.	31,60
	LMGF-13-POM/56	Adapter für Führung LMGF	Grau	1 Stk.	7,60



Saint-Gobain Logli S.r.l.
Via Chemnitz, 49/51
59100 Prato - Italien
www.sg-logli.it

